

LS-5 v2 Series

Technical Manual | Circuit Breaker Control



LS-5x1 (v2) 1breaker

Software Version 2.00xx

37649

This is the original technical description (no translation).
Designed and produced in the European Union.

Woodward GmbH

Handwerkstrasse 29

70565 Stuttgart

Germany

Telephone: +49 (0) 711 789 54-510

Fax: +49 (0) 711 789 54-100

E-mail: stgt-info@woodward.com

Internet: <http://www.woodward.com>

Brief Overview

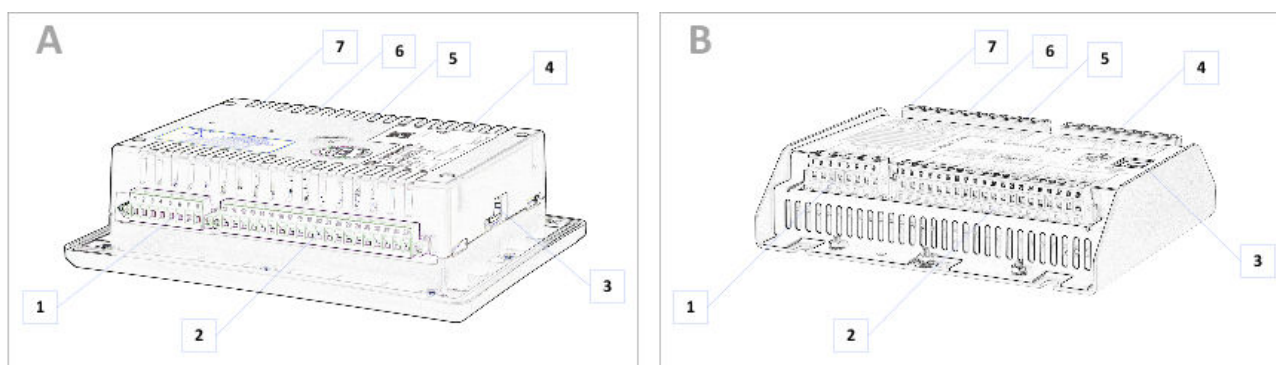

Fig. 1: LS-5x1 Series (housing variants)

- | | | | |
|---|--|---|----------------------------|
| A | LS-521 (plastic housing with display) | 4 | Relay outputs terminal |
| B | LS-511 (sheet metal housing) | 5 | Discrete inputs terminal |
| 1 | System A CT terminal | 6 | CAN bus interface terminal |
| 2 | System A / System B PT terminal | 7 | RS-485 interface terminal |
| 3 | Service port connector (USB/RS-232) ¹ | | |



¹ Optional configuration cable for ToolKit configuration software and external extensions/applications required:

- USB connector: DPC-USB direct configuration cable – P/N 5417-1251
- RS-232 connector: DPC-RS-232 direct configuration cable – P/N 5417-557

The LS-5 Series are circuit breaker control units for engine-generator system management applications.



The control units can be used stand-alone or in applications in combination with Woodward easYgen-3400/3500 or easYgen-3400XT/3500XT genset control units.

Sample application setup

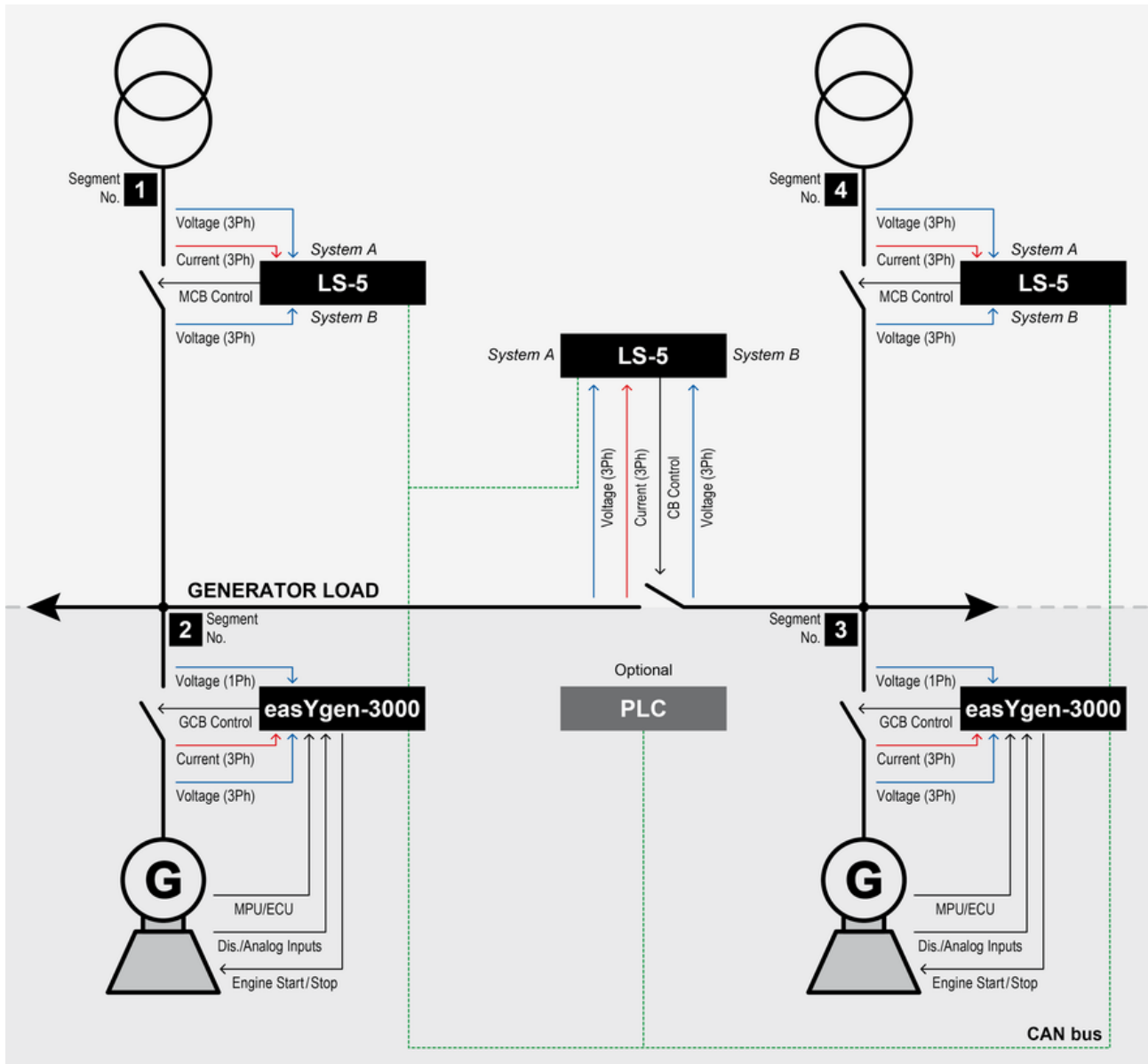

Fig. 2: Sample application setup

A typical application mode for the control unit is the use as an external mains circuit breaker.

- One or more gensets feed on a load busbar.
- The easYgen(s) close and open their own generator breaker.
- The LS-5 at the interchange point closes and opens the MCB.



For a listing of additional application modes and setups please refer to chapter ↪ Chapter 6 “Application” on page 189.

Scope of delivery

The following parts are included in the scope of delivery. Please check prior to the installation that all parts are present.

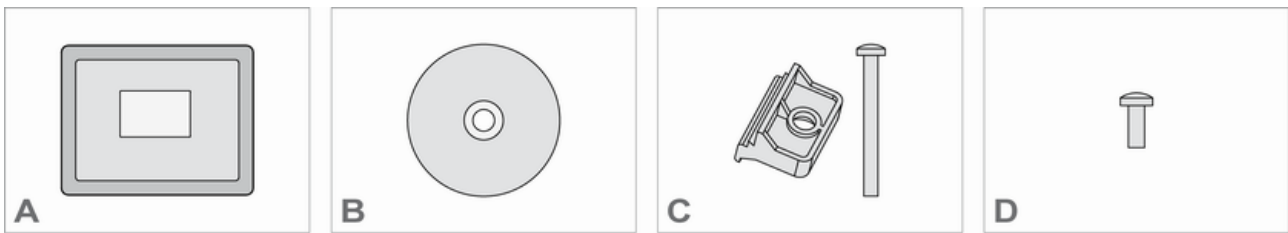

Fig. 3: Scope of delivery - schematic

- A LS-5 circuit breaker control
- B Product CD-ROM (configuration software and manual)
- C LS-52x only: Clamp fastener installation material - 4x
- D LS-52x only: Screw kit installation material - 8x

Table of contents

1	General Information	15
1.1	About This Manual.....	15
1.1.1	Revision History.....	15
1.1.2	Depiction Of Notes And Instructions.....	15
1.2	Copyright And Disclaimer.....	16
1.3	Service And Warranty.....	17
1.4	Safety.....	17
1.4.1	Intended Use.....	17
1.4.2	Personnel.....	18
1.4.3	General Safety Notes.....	19
1.4.4	Protective Equipment And Tools.....	22
2	System Overview	25
2.1	Display And Status Indicators.....	26
2.2	Hardware Interfaces (Terminals).....	27
2.3	Application Modes.....	28
2.4	Operation Modes.....	29
2.5	Synch. Check Functionality.....	29
3	Installation	31
3.1	Mount Unit (Sheet Metal Housing).....	31
3.2	Mount Unit (Plastic Housing).....	32
3.2.1	Clamp Fastener Installation.....	33
3.2.2	Screw Kit Installation.....	34
3.3	Setup Connections.....	36
3.3.1	Terminal Allocation.....	36
3.3.2	Wiring Diagram.....	37
3.3.3	Power Supply.....	40
3.3.4	Voltage Measuring.....	41
3.3.4.1	Isolation switch location.....	41
3.3.4.2	System A Voltage.....	43
3.3.4.3	System B Voltage.....	50
3.3.5	Current Measuring.....	55
3.3.5.1	Current Measuring (System A).....	56
3.3.6	Power Measuring.....	57
3.3.7	Power Factor Definition.....	58
3.3.8	Discrete Inputs.....	59
3.3.9	Relay Outputs.....	60
3.3.10	Serial Interface.....	61
3.3.10.1	RS-485 Interface.....	61

3.3.11	Service Port.....	62
3.4	CAN Bus Interface.....	64
3.5	Connecting 24 V Relays.....	65
4	Configuration.....	67
4.1	Basic Setup.....	67
4.1.1	Configure Language/Clock.....	67
4.1.2	Configure Display.....	71
4.1.3	Enter Password.....	71
4.1.4	System Management.....	73
4.1.5	Password System.....	74
4.1.6	Configure Status/Monitoring (home) screen.....	74
4.2	Configure Measurement.....	75
4.2.1	Configure Transformer.....	78
4.3	Configure Monitoring.....	79
4.3.1	System A.....	79
4.3.1.1	System A Operating Voltage / Frequency.....	80
4.3.1.2	System A Decoupling.....	81
4.3.1.3	Phase Shift.....	82
4.3.1.4	df/dt (ROCOF).....	84
4.3.1.5	System A Overfrequency (Levels 1 & 2) ANSI# 81O.....	85
4.3.1.6	System A Underfrequency (Level 1 & 2) ANSI# 81U.....	86
4.3.1.7	System A Overvoltage (Level 1 & 2) ANSI# 59.....	87
4.3.1.8	System A Undervoltage (Level 1 & 2) ANSI# 27.....	88
4.3.1.9	System A Voltage Asymmetry.....	90
4.3.1.10	System A Voltage Increase.....	91
4.3.1.11	Setup System A for VDE-AR-N 4105.....	93
4.3.1.12	QV Monitoring.....	97
4.3.1.13	System A Time-Dependent Voltage.....	99
4.3.1.14	System A Phase Rotation.....	102
4.3.2	System B.....	104
4.3.2.1	System B Operating Voltage / Frequency.....	104
4.3.2.2	System B Voltage Phase Rotation.....	105
4.3.3	Breaker.....	106
4.3.3.1	CBA.....	106
4.3.3.2	Synchronization CBA	107
4.3.3.3	CBA Unload Mismatch.....	108
4.3.3.4	System A / System B Phase Rotation.....	109
4.3.4	Voltage plausibility.....	110
4.3.5	Operating range.....	111
4.3.6	CAN Interface.....	112
4.3.7	Battery Overvoltage (Level 1 & 2).....	113

4.3.8	Battery Undervoltage (Level 1 & 2).....	114
4.3.9	Free Configurable Alarms.....	115
4.3.10	Multi-Unit Missing Members.....	116
4.3.11	Global settings.....	118
4.3.11.1	Alarm Acknowledgement.....	118
4.4	Configure Application.....	118
4.4.1	Application Mode.....	118
4.4.2	Breakers.....	120
4.4.2.1	Dead Bus Closure CB.....	120
4.4.2.2	Configure CBA.....	121
4.4.2.3	Synchronization Configuration.....	124
4.4.2.4	Configure Synchronous network.....	126
4.4.3	Configure Segment.....	127
4.4.4	Automatic Run.....	131
4.5	Inputs And Outputs.....	132
4.5.1	Discrete Inputs.....	132
4.5.2	Discrete Outputs (LogicsManager).....	135
4.6	Configure Interfaces.....	136
4.6.1	General.....	136
4.6.2	CAN Interface.....	137
4.6.2.1	CAN Interface 1.....	137
4.6.2.2	Additional Server SDOs (Service Data Objects).....	139
4.6.2.3	Receive PDO {x} (Process Data Object).....	140
4.6.2.4	Transmit PDO {x} (Process Data Object).....	141
4.6.3	RS-232 Interface.....	144
4.6.4	RS-485 Interface.....	144
4.6.5	Modbus Protocol (5300 Multiple).....	145
4.7	Configure LogicsManager.....	146
4.8	Configure Counters.....	151
5	Operation.....	153
5.1	Access Via PC (ToolKit).....	153
5.1.1	Install ToolKit.....	153
5.1.2	Install ToolKit Configuration Files.....	155
5.1.3	Configure ToolKit.....	157
5.1.4	Connect ToolKit.....	158
5.1.5	View And Set Values In ToolKit.....	160
5.1.6	Special Screens.....	162
5.2	Front Panel Access.....	167
5.2.1	Basic Navigation.....	167
5.2.2	Parameter Setting Screens.....	174
5.2.2.1	Navigation Screens.....	174

5.2.2.2	Value Setting Screens.....	174
5.2.2.3	LogicsManager Setting screens.....	175
5.2.3	Main Menu Screens.....	176
5.2.3.1	Main Screen Display.....	176
5.2.3.2	Alarm List.....	177
5.2.3.3	System A.....	178
5.2.3.4	System B.....	178
5.2.3.5	System Angles.....	178
5.2.3.6	Synchroscope.....	179
5.2.3.7	LogicsManager Conditions.....	179
5.2.3.8	Event History.....	179
5.2.3.9	States easYgen.....	180
5.2.3.10	States LS-5.....	180
5.2.3.11	Segments LS-5.....	181
5.2.3.12	Discrete Inputs/Outputs.....	181
5.2.3.13	Analog Input.....	182
5.2.3.14	System A Decoupling Thresholds.....	182
5.2.3.15	Test System A Decoupling (VDE-AR-N 4105).....	183
5.2.3.16	Counters.....	184
5.2.3.17	Actual Date And Time.....	184
5.2.3.18	Version.....	185
5.3	Change Operating Modes.....	185
5.3.1	Operating Mode MANUAL.....	185
5.3.2	Operating Mode AUTOMATIC.....	186
5.4	Restore Language Setting.....	186
6	Application.....	189
6.1	Application Modes Overview.....	189
6.1.1	LS-5x1: Stand-Alone Application Mode.....	190
6.1.2	LS-5x1 & easYgen-3400/3500 or easYgen-3400XT/3500XT: Common Application Modes..	190
6.1.2.1	LS-5x1 View.....	190
6.1.2.2	easYgen-3400/3500 or easYgen-3400XT/3500XT View.....	191
6.2	Setup Stand-Alone Applications (Mode A01).....	193
6.3	Setup easYgen & Slave LS-5 Applications (Mode A03 & A04).....	196
6.3.1	Introduction.....	196
6.3.2	Single Or Multiple easYgen With One Externally Operated MCB.....	198
6.3.3	Multiple easYgen With One GGB And One Externally Operated MCB.....	202
6.3.4	Multiple easYgen With One Externally Operated GGB In Isolated Operation.....	207
6.3.5	Multiple easYgen With One Externally Operated GGB And One Externally Operated MCB..	210
6.4	Setup easYgen & Independent LS-5 Applications (Mode A02).....	215
6.4.1	Introduction.....	215
6.4.2	General Functions.....	217

6.4.2.1	General Preparation.....	217
6.4.2.2	Setup Mains Measurement With easYgen.....	217
6.4.2.3	Setup Mains Decoupling With easYgen.....	218
6.4.2.4	Setup Mains Decoupling With LS-5.....	219
6.4.2.5	Setup Run-Up Synchronization In LS-5 Mode.....	221
6.4.2.6	Setup AMF Start In LS-5 Mode.....	221
6.4.2.7	Setup Manual Breaker Control In LS-5 Mode.....	223
6.4.2.8	Setup LS-5 Command Bits From easYgen To LS-5.....	223
6.4.2.9	Setup LS-5 Flags From LS-5 To LS-5 And easYgen.....	224
6.4.3	H-Configuration With Two easYgen And Two Incoming Mains And Tie-breaker.....	226
6.4.4	Multiple Mains/Generators With Four easYgen Units, Two Incoming Mains And Different Tie-breakers.....	236
6.5	Setup VDE-AR-N 4105 Applications.....	250
6.5.1	Introduction.....	250
6.5.2	easYgen-3200XT (Mode GCB/MCB) with LS-521 as separate mains decoupling device.....	251
6.5.3	One easYgen-3500(XT) (Mode GCB/L-MCB or GCB/GGB/L-MCB) with LS-521.....	252
6.5.4	Multiple easYgen-3500(XT) (Mode GCB/L-MCB or GCB/GGB/L-MCB) with LS-521.....	252
6.5.5	System easYgen-3500(XT) (Mode GCB/LS5) with LS-521.....	253
6.5.5.1	Mains Decoupling Monitoring at the Interchange Point.....	253
6.5.5.2	Mains Decoupling Monitoring at the Generator Feed-in.....	254
7	Interfaces And Protocols.....	257
7.1	Interfaces.....	257
7.1.1	Interfaces Overview.....	257
7.1.2	CAN Interfaces.....	258
7.1.2.1	CAN Interface 1 (Guidance level).....	258
7.1.3	Serial Interfaces.....	258
7.1.3.1	Service Port (RS-232/USB).....	258
7.1.3.2	RS-485 Interface.....	259
7.2	Protocols.....	259
7.2.1	Protocols Overview.....	259
7.2.2	CANopen Protocol.....	259
7.2.3	Modbus Protocol.....	260
8	Technical Specifications.....	265
8.1	Technical Data.....	265
8.1.1	Measuring Values.....	265
8.1.2	Ambient Variables.....	266
8.1.3	Inputs/Outputs.....	266
8.1.4	Interface.....	267
8.1.5	Battery.....	267
8.1.6	Housing.....	268

8.1.7	Approvals.....	268
8.1.8	Generic Note.....	268
8.2	Environmental Data.....	268
8.3	Accuracy.....	269
9	Appendix.....	271
9.1	Characteristics.....	271
9.1.1	Triggering Characteristics.....	271
9.2	Data Protocols.....	273
9.2.1	CANopen.....	273
9.2.1.1	Data Protocol 5301 (Basic Visualization).....	273
9.2.1.2	Data Protocol 5302 (Basic Visualization).....	290
9.2.1.3	Protocol 6003 (LS-5 Communication).....	306
9.2.2	Modbus.....	312
9.2.2.1	Data Protocol 5300 (Basic Visualization).....	312
9.2.3	Additional Data Identifier.....	353
9.2.3.1	Transmit Data.....	353
9.3	LogicsManager Reference.....	354
9.3.1	LogicsManager Overview.....	354
9.3.2	Logical Symbols.....	356
9.3.3	Logical Outputs.....	357
9.3.4	Logical Command Variables.....	360
9.3.4.1	Group 00: Flags Condition 1.....	360
9.3.4.2	Group 01: Alarm System.....	362
9.3.4.3	Group 02: Systems Condition.....	362
9.3.4.4	Group 04: Applications Condition.....	364
9.3.4.5	Group 05: Device Related Alarms.....	365
9.3.4.6	Group 06: System B Related Alarms.....	366
9.3.4.7	Group 07: System A Related Alarms.....	366
9.3.4.8	Group 08: System Related Alarms.....	366
9.3.4.9	Group 09: Discrete Inputs.....	367
9.3.4.10	Group 11: Clock And Timer.....	367
9.3.4.11	Group 13: Discrete Outputs.....	368
9.3.4.12	Group 17: Alarm System 2.....	368
9.3.4.13	Group 24: Flags Condition 2.....	369
9.3.4.14	Group 26(/1-2): Commands Device 33 to 48.....	370
9.3.4.15	Group 27(/1-2): Commands Device 49 to 64.....	372
9.3.4.16	Group 28: LS-5 System Conditions.....	374
9.3.4.17	Group 29(/1-3): Commands Device 1 to 16.....	375
9.3.4.18	Group 30(/1-3): Commands Device 17 to 32.....	378
9.3.5	Factory Settings.....	381
9.4	Event And Alarm Reference.....	384

9.4.1	Alarm Classes.....	384
9.4.2	Status Messages.....	385
9.4.3	Event History.....	386
9.4.3.1	Event Messages.....	386
9.4.3.2	Alarm Messages.....	387
9.5	Additional Application Information.....	390
9.5.1	Synchronization Of System A and System B.....	390
10	Glossary And List Of Abbreviations.....	393
11	Index.....	395

1 General Information



This manual describes the LS-5 one breaker variant:

- LS-5x1 v2 series device
- LS-5x2 v2 series device configured and used as LS-5x1 v2

For details please refer to chapter [Chapter 2 “System Overview”](#) on page 25.

1.1 About This Manual

1.1.1 Revision History

Rev.	Date	Editor	Changes in chronological descending order
NEW	2017-05	GG, MK	1st Release with <ul style="list-style-type: none"> ■ software version 2.00xx and ■ ToolKit version 5.4 or higher

1.1.2 Depiction Of Notes And Instructions

Safety instructions

Safety instructions are marked with symbols in these instructions. The safety instructions are always introduced by signal words that express the extent of the danger.



DANGER!

This combination of symbol and signal word indicates an immediately-dangerous situation that could cause death or severe injuries if not avoided.



WARNING!

This combination of symbol and signal word indicates a possibly-dangerous situation that could cause death or severe injuries if it is not avoided.



CAUTION!

This combination of symbol and signal word indicates a possibly-dangerous situation that could cause slight injuries if it is not avoided.



NOTICE!

This combination of symbol and signal word indicates a possibly-dangerous situation that could cause property and environmental damage if it is not avoided.

Tips and recommendations



This symbol indicates useful tips and recommendations as well as information for efficient and trouble-free operation.

Additional markings

To emphasize instructions, results, lists, references, and other elements, the following markings are used in these instructions:

Marking	Explanation
	Step-by-step instructions
	Results of action steps
	References to sections of these instructions and to other relevant documents
	Listing without fixed sequence
[Buttons]	Operating elements (e.g. buttons, switches), display elements (e.g. signal lamps)
"Display"	Screen elements (e.g. buttons, programming of function keys)
"Screen xx → Screen xy → Screen xz" ...	Menu path. The following information and setting refer to a page on HMI screen or ToolKit located as described here.
 	Some parameters/settings/screens are available only either in ToolKit or in HMI/display.



Dimensions in Figures

All dimensions shown with no units specified are in mm.

1.2 Copyright And Disclaimer

Disclaimer

All information and instructions in this manual have been provided under due consideration of applicable guidelines and regulations, the current and known state of the art, as well as our many years of in-house experience. Woodward assumes no liability for damages due to:

- Failure to comply with the instructions in this manual
- Improper use / misuse
- Willful operation by non-authorized persons
- Unauthorized conversions or non-approved technical modifications
- Use of non-approved spare parts

The originator is solely liable to the full extent for damages caused by such conduct. The agreed upon obligations in the delivery contract, the general terms and conditions, the manufacturer's delivery conditions, and the statutory regulations valid at the time the contract was concluded, apply.

Copyright

This manual is protected by copyright. No part of this manual may be reproduced in any form or incorporated into any information retrieval system without written permission of Woodward GmbH.

Delivery of this manual to third parties, duplication in any form - including excerpts - as well as exploitation and/or communication of the content, are not permitted without a written declaration of release by Woodward GmbH.

Actions to the contrary will entitle us to claim compensation for damages. We expressly reserve the right to raise any further accessory claims.

1.3 Service And Warranty

Our Customer Service is available for technical information.

For regional support, please refer to:

http://www.woodward.com/Support_pgd.aspx.

In addition, our employees are constantly interested in new information and experiences that arise from usage and could be valuable for the improvement of our products.

Warranty terms



Please enquire about the terms of warranty from your nearest Woodward representative.

*For our contact search webpage please go to:
<http://www.woodward.com/Directory.aspx>*

1.4 Safety

1.4.1 Intended Use

The circuit breaker control unit has been designed and constructed solely for the intended use described in this manual.



The control units can be used stand-alone or in applications in combination with Woodward easYgen-3400/3500 or easYgen-3400XT/3500XT genset control units.

The circuit breaker control unit must be used exclusively for engine-generator system management applications.

- Intended use requires operation of the control unit within the specifications listed in [Chapter 8.1 "Technical Data" on page 265](#).
- All permissible applications are outlined in [Chapter 6 "Application" on page 189](#).
- Intended use also includes compliance with all instructions and safety notes presented in this manual.
- Any use which exceeds or differs from the intended use shall be considered improper use.
- No claims of any kind for damage will be entertained if such claims result from improper use.



NOTICE!

Damage due to improper use!

Improper use of the circuit breaker control unit may cause damage to the control unit as well as connected components.

Improper use includes, but is not limited to:

- Operation outside the specified operation conditions.

1.4.2 Personnel



WARNING!

Hazards due to insufficiently qualified personnel!

If unqualified personnel perform work on or with the control unit hazards may arise which can cause serious injury and substantial damage to property.

- Therefore, all work must only be carried out by appropriately qualified personnel.

This manual specifies the personnel qualifications required for the different areas of work, listed below:

Qualified electrician

The qualified electrician is able to execute tasks on electrical equipment and independently detect and avoid any possible dangers due to his training, expertise and experience, as well as knowledge of all applicable regulations.

The qualified electrician has been specially trained for the work environment in which he is active and is familiar with all relevant standards and regulations.

User

The user operates the device within the limits of its intended use, without additional previous knowledge but according to the instructions and safety notes in this manual.

The workforce must only consist of persons who can be expected to carry out their work reliably. Persons with impaired reactions due to, for example, the consumption of drugs, alcohol, or medication are prohibited.

When selecting personnel, the age-related and occupation-related regulations governing the usage location must be observed.

1.4.3 General Safety Notes

Electrical hazards

**DANGER!****Life-threatening hazard from electric shock!**

There is an imminent life-threatening hazard from electric shocks from live parts. Damage to insulation or to specific components can pose a life-threatening hazard.

- Only a qualified electrician should perform work on the electrical equipment.
- Immediately switch off the power supply and have it repaired if there is damage to the insulation.
- Before beginning work at live parts of electrical systems and resources, cut the electricity and ensure it remains off for the duration of the work. Comply with the five safety rules in the process:
 - cut electricity;
 - safeguard against restart;
 - ensure electricity is not flowing;
 - earth and short-circuit; and
 - cover or shield neighboring live parts.
- Never bypass a fuse or render it inoperable. Always use the correct amperage when changing a fuse.
- Keep moisture away from live parts. Moisture can cause short circuits.

Prime mover safety

**WARNING!****Hazards due to insufficient prime mover protection**

The engine, turbine, or other type of prime mover should be equipped with an overspeed (over-temperature, or over-pressure, where applicable) shut-down device(s), that operates totally independently of the prime mover control device(s) to protect against runaway or damage to the engine, turbine, or other type of prime mover with possible personal injury or loss of life should the mechanical-hydraulic governor(s) or electric control(s), the actuator(s), fuel control(s), the driving mechanism(s), the linkage(s), or the controlled device(s) fail.

Modifications



WARNING!

Hazards due to unauthorized modifications

Any unauthorized modifications to or use of this equipment outside its specified mechanical, electrical, or other operating limits may cause personal injury and/or property damage, including damage to the equipment.

Any unauthorized modifications:

- constitute "misuse" and/or "negligence" within the meaning of the product warranty thereby excluding warranty coverage for any resulting damage
- invalidate product certifications or listings.

Use of batteries/alternators



NOTICE!

Damage to the control system due to improper handling

Disconnecting a battery from a control system that uses an alternator or battery-charging device whilst the charging device is still connected causes damage to the control system.

- Make sure the charging device is turned off before disconnecting the battery from the system.



Unit includes a lithium backup battery for Real Time Clock. Field replacement of the battery is not allowed.

In case of battery replacement please contact your Woodward service partner.

Electrostatic discharge

Protective equipment: ■ ESD wrist band



NOTICE!

Damage from electrostatic discharge

All electronic equipment sensitive to damage from electrostatic discharge, which can cause the control unit to malfunction or fail.

- To protect electronic components from static damage, take the precautions listed below.



1. Avoid build-up of static electricity on your body by not wearing clothing made of synthetic materials. Wear cotton or cotton-blend materials as much as possible because these do not store static electric charges as easily as synthetics.
2. Before working on terminals on the control unit, ground yourself by touching and holding a grounded metal object (pipes, cabinets, equipment, etc.) to discharge any static electricity. Alternatively wear an ESD wrist band connected to ground.
3. Before any maintenance work on the control unit, ground yourself by touching and holding a grounded metal object (pipes, cabinets, equipment, etc.) to discharge any static electricity. Alternatively wear an ESD wrist band connected to ground.
4. Keep plastic, vinyl, and Styrofoam materials (such as plastic or Styrofoam cups, cigarette packages, cellophane wrappers, vinyl books or folders, plastic bottles, etc.) away from the control unit, modules and work area.
5. Opening the control cover may void the unit warranty. Do not remove the printed circuit board (PCB) from the control cabinet unless instructed by this manual.



If instructed by this manual to remove the PCB from the control cabinet, follow these precautions:

- *Ensure that the device is completely voltage-free (all connectors have to be disconnected).*
- *Do not touch any part of the PCB except the edges.*
- *Do not touch the electrical conductors, connectors, or components with conductive devices or with bare hands.*
- *When replacing a PCB, keep the new PCB in the plastic antistatic protective bag it comes in until you are ready to install it. Immediately after removing the old PCB from the control cabinet, place it in the antistatic protective bag.*



For additional information on how to prevent damage to electronic components caused by improper handling, read and observe the precautions in:

- *"Woodward manual 82715, Guide for Handling and Protection of Electronic Controls, Printed Circuit Boards, and Modules".*

Notes on marine usage

Marine usage of the LS-5 circuit breaker control requires additional precautions as listed below:



The specified marine approvals are only valid for plastic housing units, if they are installed using the screw kit.

- *Use all 8 screws and tighten accordingly.*

- The LS-5 Series has no internally isolated power supply.



NOTICE!

Malfunctions due to insufficient protection against electromagnetic interference

Exposure electromagnetic interference may cause malfunctions or incorrect internal readings.

- Install an EMI filter (i.e. SCHAFFNER - FN 2070-3-06) for the power supply inputs when using the control unit in marine applications.



Some additional, independent safety and protection devices are necessary to meet safety requirements of Rules and Regulations of marine Classification Societies.

- *Please refer to the corresponding documents issued by marine Classification Societies for the applicable requirements.*

1.4.4 Protective Equipment And Tools

Protective gear

Personal protective equipment serves to protect risks to the safety and health of persons as well as to protect delicate components during work.

Certain tasks presented in this manual require the personnel to wear protective equipment. Specific required equipment is listed in each individual set of instructions.

The cumulative required personal protective equipment is detailed below:

ESD wrist band

The ESD (electrostatic discharge) wrist band keeps the user's body set to ground potential. This measure protects sensitive electronic components from damage due to electrostatic discharge.

Tools

Use of the proper tools ensures successful and safe execution of tasks presented in this manual.

Specific required tools are listed in each individual set of instructions.

The cumulative required tools are detailed below:

Torque screwdriver

A torque-screwdriver allow fastening of screws to a precisely specified torque.

- Note the required torque range individually specified in the tasks listed in this manual.

2 System Overview

This chapter provides a basic overview of the circuit breaker control unit.



1 breaker variant

A one breaker variant can either be an LS-5x1 v2 series device or an LS-5x2 v2 series device that is configured and used as LS-5x1 v2.

To use an LS-5x2 v2 series device as LS-5x1 v2

- *a few settings must be done (see manual of the LS-5x2 v2 series),*
- *wiring will use 1 breaker pins only,*
- *at the main screen the softkeys B4 and B5 have switched meanings: B4 is used to open / close the circuit breaker in MANUAL mode, B5 is used to change the type of voltage display*
- *and (plastic housing variant only) an adhesive label (part of delivery) should be used to cover the second breaker at the front panel.*



Configure LS-5x2 v2 series 1 breaker variant back to 2 breaker variant

Please refer to the manual of the LS-5x2 v2 series how to configure an LS-5x2 v2 series device that is used as one breaker variant (LS-5x1) back to a two breaker variant (LS-5x2).



DANGER!

Be aware that there are differences

- in terminals between an LS-5x1 series device, an LS-5x1 v2 series device and an LS-5x2 v2 series device.
- in behavior between an LS-5x1 v2 series device and an LS-5x2 v2 series device.

Refer to the comprehensive chapters indicated below to commission the control unit:

- *Chapter 3 “Installation” on page 31* provides information on how to mount the unit and setup connections.
- *Chapter 4 “Configuration” on page 67* provides information on basic setup and reference information on all configurable parameters.
- *Chapter 5 “Operation” on page 153* provides information on how to access the unit via the front panel or remotely using the ToolKit software provided by Woodward.
- *Chapter 6 “Application” on page 189* provides application examples as well as instructions for the corresponding required configuration.
- *Chapter 7 “Interfaces And Protocols” on page 257* provides reference information on the usage of the interfaces and protocols provided by the control unit.

2.1 Display And Status Indicators

LS-521 display



Fig. 4: Display LS-521

The display (Fig. 4) as part of the LS-521 is used for direct access to status information and configuration.



For information on the usage of the graphical user interface refer to Chapter 5.2 "Front Panel Access" on page 167.

The LS-511 is not equipped with a display and requires remote access for configuration (Chapter 5.1 "Access Via PC (ToolKit)" on page 153).



Fig. 5: Display LS-522 configured as LS-521

LS-511 LEDs

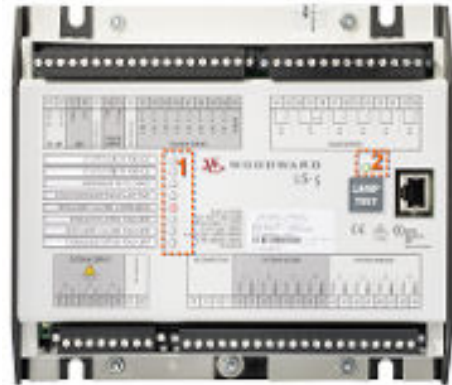

Fig. 6: Position of LEDs

- 1 LEDs representing LogicsManager states
- 2 LED 'CPU OK'

The LS-511 unit with metal housing and without display and buttons features 9 LEDs (Fig. 6) on the front plate.

The LEDs indicate the following states:

State	Indication
<input type="checkbox"/> NOT illuminated	Not triggered (LogicsManager condition not met).
<input checked="" type="checkbox"/> Illuminated red	Triggered (LogicsManager condition met).
	<p>Notes</p> <p>The 8 LEDs representing LogicsManager states are triggered based on the settings of parameters 12962 p. 148 to 12969 p. 148.</p> <p>The conditions printed next to the LEDs on the sheet metal housing represent the corresponding LogicsManager's parameter defaults.</p>

Table 1: LEDs 'LogicsManager states'

State	Indication
<input type="checkbox"/> NOT illuminated	CPU error/unit offline.
<input checked="" type="checkbox"/> Illuminated green	CPU OK.

Table 2: LED 'CPU OK'

**Defaults**

The 8 LEDs representing LogicsManager states are triggered based on the settings of parameters 12962 ↗ p. 148 to 12969 ↗ p. 148.

The conditions printed next to the LEDs on the sheet metal housing represent the corresponding LogicsManager's parameter defaults. This is done by an inserted paper strip that can be exchanged by customer.

How to exchange paper strip:

Fig. 7: Exchange paper strip

This paper strip can be exchanged:

1. Use template "Paper-strip_LED_1-8" to create your own text.
⇒ PRINT
2. Un-mount Terminal 43..59
3. Pull factory mounted paper strip out
4. Insert new paper strip
⇒ Check that full text is readable and related to the according LED
5. Mount terminal 43..9

2.2 Hardware Interfaces (Terminals)

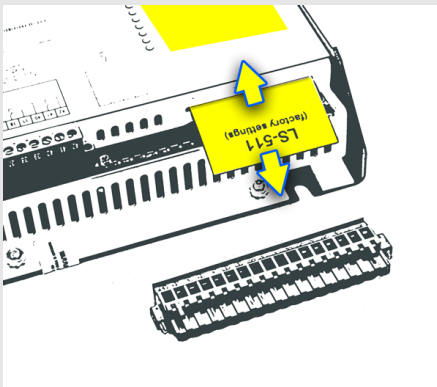
The LS-51x/52x (Fig. 8) provides the following terminals.

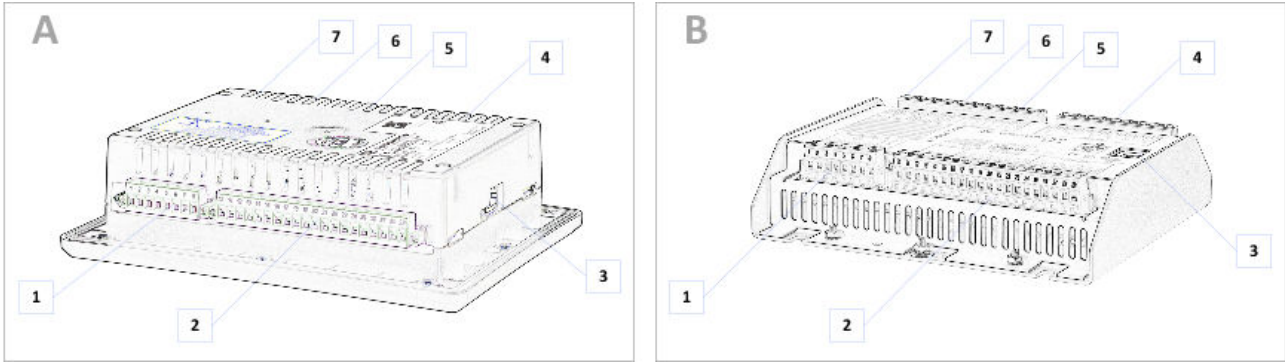

Fig. 8: LS-5 Series (housing variants)

- A LS-52x (plastic housing with display)
- B LS-51x (sheet metal housing)
- 1 System A CT terminal
- 2 System A / System B PT terminal
- 3 Service port connector (USB/RS-232)¹
- 4 Relay outputs terminal
- 5 Discrete inputs terminal
- 6 CAN bus interface terminal
- 7 RS-485 interface terminal



¹ Optional configuration cable for ToolKit configuration software and external extensions/applications required:

- USB connector: DPC-USB direct configuration cable – P/N 5417-1251
- RS-232 connector: DPC-RS-232 direct configuration cable – P/N 5417-557



For information on how to setup connections refer to [Chapter 3.3 “Setup Connections”](#) on page 36.

For information on the interfaces and protocols refer to [Chapter 7 “Interfaces And Protocols”](#) on page 257.







2.3 Application Modes

The circuit breaker control provides the following basic functions via the application modes listed below.



For detailed information on the application modes and special applications refer to [Chapter 6 “Application”](#) on page 189.

	LS-511/521		easYgen-3400/3500 or easYgen-3400XT/3500XT	
	Mode	Symbol	Mode	Symbol
LS-5	Single LS5		N/A	N/A
LS-5 & easYgen	LS5 (up to 16 units)		GCB/LS5	

LS-511/521		easYgen-3400/3500 or easYgen-3400XT/3500XT	
Mode	Symbol	Mode	Symbol
L-MCB (max. 1 unit)		GCB/L-MCB	
		GCB/GGB/L-MCB	
L-GGB (max. 1 unit)		GCB/L-GGB/L-MCB	
		GCB/L-GGB	

2.4 Operation Modes

The LS-5 offers two operation modes:

- AUTOMATIC (AUTO)
- MANUAL (MAN)
- ... and an internal (non) operating phase during starting the device itself

The plastic housing (HMI) version of the LS-5 enables to select an operation mode by pressing the according button at the front panel if current settings allow this function.

For more information about the operation modes please see [Chapter 5.3 "Change Operating Modes" on page 185](#).

2.5 Synch. Check Functionality

General notes

To use the LS-5 synchronization check functionality (Synch. Check) there are three command variables available for LogicsManager™:

- **02.29 Sync. Condition**
- **02.30 Dead Bus Closure Condition**
- **02.28 Sync. Check Relay**





WARNING!

No dead bus interlocking!

Synch. Check is intended to be a redundant check function enhancing system security. Don't use for CBA control!



The Synch. Check functionality is available in every application mode, but be aware that application modes can fix parameters being relevant for this functionality. The application modes L-MCB () and L-GGB () fix those parameters!

Synchronization mode is "Phase Matching" only. (Parameter 5730 [p. 122 'Synchronization CBA' doesn't care.](#))



Synch. Check command variables don't care about:

- System conditions like blocking from other devices e.g. dead bus interlocking
- Synchronization signals from discrete inputs (DI) like enable close CBA or open CBA
- Synchronization control conditions like mains settling time

Variables and Parameters

02.29 Sync Condition depends on

- Voltage,
- Frequency and
- Phase angle.

The command variable Sync Condition 02.29 [↪ Chapter 9.3.4.3 “Group 02: Systems Condition” on page 362](#) is true, if the phase matching synchronisation conditions are met according to parameters 5711 [↪ p. 123](#), 5712 [↪ p. 123](#), 5710 [↪ p. 123](#), 8825 [↪ p. 125](#), 8824 [↪ p. 125](#), 5713 [↪ p. 124](#), 5714 [↪ p. 124](#), and 5717 [↪ p. 124](#). Parameter 5730 [↪ p. 122](#) doesn't care. For more details refer to [↪ Table on page 122](#).

02.30 Dead Bus Closure Condition depends on

- Voltage System A and System B and
- Dead Bus configuration.

The command variable Dead Bus Closure Condition 02.30 [↪ Chapter 9.3.4.3 “Group 02: Systems Condition” on page 362](#) is true, if the dead bus closure conditions are met according to parameters 8801 [↪ p. 120](#), 5820 [↪ p. 120](#), 8805 [↪ p. 120](#), 8802 [↪ p. 120](#), 8803 [↪ p. 121](#) and 8804 [↪ p. 121](#). For more details refer to [↪ Table on page 120](#).

02.28 Sync. Check Relay depends on

- Sync. Check condition and
- Dead Bus Closure condition.

The command variable Sync. Check Relay 02.28 [↪ Chapter 9.3.4.3 “Group 02: Systems Condition” on page 362](#) is true, if the phase matching synchronisation conditions are met according to parameters 5711 [↪ p. 123](#), 5712 [↪ p. 123](#), 5710 [↪ p. 123](#), 8825 [↪ p. 125](#), 8824 [↪ p. 125](#), 5713 [↪ p. 124](#), 5714 [↪ p. 124](#), and 5717 [↪ p. 124](#) (parameter 5730 [↪ p. 122](#) doesn't care) or

if the dead bus closure conditions are met according to parameters 8801 [↪ p. 120](#), 5820 [↪ p. 120](#), 8805 [↪ p. 120](#), 8802 [↪ p. 120](#), 8803 [↪ p. 121](#), and 8804 [↪ p. 121](#).

For more details refer to [↪ Table on page 122](#) or [↪ “General notes” on page 120](#).

3 Installation

3.1 Mount Unit (Sheet Metal Housing)

Dimensions

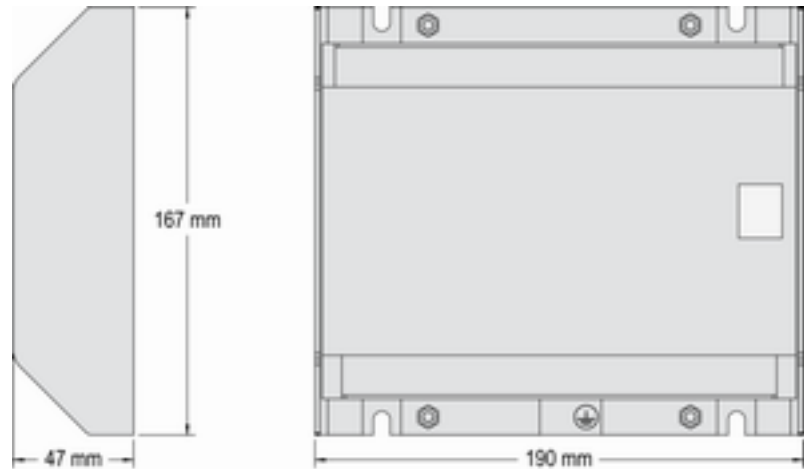

Fig. 9: Sheet metal housing - dimensions

Mounting into a cabinet

Special tool: ■ Torque screwdriver

Proceed as follows to install the unit using the screw kit:

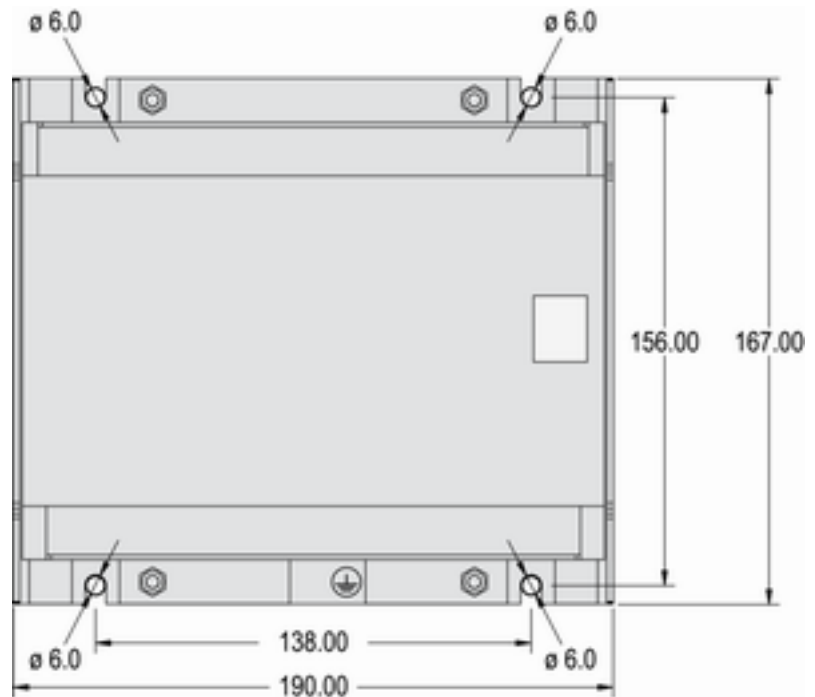

Fig. 10: Sheet metal housing - drill plan

1. Drill the holes according to the dimensions in Fig. 10 (dimensions shown in mm).



Ensure sufficient clearance for access to the terminals (top and bottom) and connectors located at the sides.

2. Mount the unit to the back panel and insert the screws.

3. Tighten the screws to a torque according to the quality class of the used screws.



Tighten the screws with a crosswise pattern to ensure even pressure distribution.



If the thickness of the panel sheet exceeds 2.5 mm, be sure to use screws with a length exceeding the panel sheet thickness by 4 mm.

3.2 Mount Unit (Plastic Housing)

Mount the unit **either** using the clamp fasteners (☞ Chapter 3.2.1 “Clamp Fastener Installation” on page 33) **or** the screw kit (☞ Chapter 3.2.2 “Screw Kit Installation” on page 34).



- Don't drill holes if you want to use the clamp fasteners. If the holes are drilled into the panel, the clamp fasteners cannot be used anymore.
- Some versions of the plastic housing are not equipped with nut inserts and may not be fastened with the screw kit.
- In order to enhance the protection to IP 66, fasten the unit with the screw kit instead of the clamp fastener hardware.

Dimensions

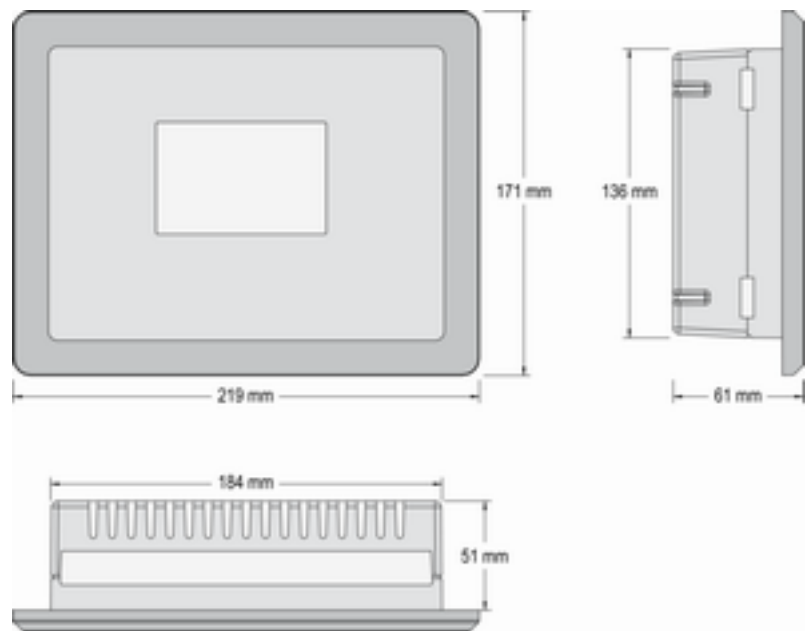

Fig. 11: Plastic housing - dimensions

Panel cutout



Fig. 12: Cutout schematic

Measure	Description		Tolerance	
H	Height	Total	171 mm	—
		Panel cutout	138 mm	+ 1.0 mm
		Housing dimension	136 mm	
W	Width	Total	219 mm	—
		Panel cutout	186 mm	+ 1.1 mm
		Housing dimension	184 mm	
Depth		Total	61 mm	—



The maximum permissible corner radius is 3.5 mm.

3.2.1 Clamp Fastener Installation

For installation into a door panel with the fastening clamps, proceed as follows:

1. ➤ Cut out the panel according to the dimensions in Fig. 12.



Don't drill the holes if you want to use the clamp fasteners. If the holes are drilled into the panel, the clamp fasteners cannot be used anymore!

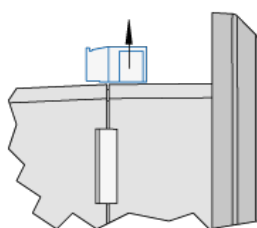

Fig. 13: Remove terminals

2. ➤ Loosen the wire connection terminal screws on the back of the unit and remove the wire connection terminal strip if required.



Fig. 14: Insert screws in clamps

3. ➤ Insert the four clamping screws into the clamp inserts from the shown side (Fig. 14; opposite the nut insert) until they are almost flush. Do not completely insert the screws into the clamp inserts.
4. ➤ Insert the unit into the panel cutout. Verify that the unit fits correctly in the cutout. If the panel cutout is not big enough, enlarge it accordingly.

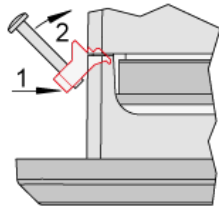

Fig. 15: Attach clamp inserts

5. Re-install the clamp inserts by tilting the insert to a 45° angle. (Fig. 15/1) Insert the nose of the insert into the slot on the side of the housing. (Fig. 15/2) Raise the clamp insert so that it is parallel to the control panel.

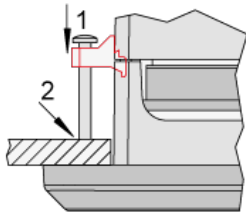

Fig. 16: Tighten clamping screws

6. Tighten the clamping screws (Fig. 16/1) until the control unit is secured to the control panel (Fig. 16/2). Over tightening of these screws may result in the clamp inserts or the housing breaking. Do not exceed the recommended tightening torque of 0.1 Nm.

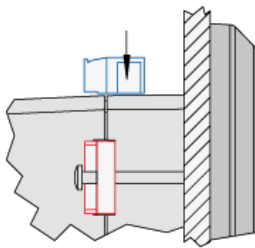

Fig. 17: Reattach terminals

7. Reattach the wire connection terminal strip (Fig. 17) and secure them with the side screws.

3.2.2 Screw Kit Installation



The housing is equipped with 8 nut inserts (Fig. 18), which must all be tightened properly to achieve the required degree of protection.

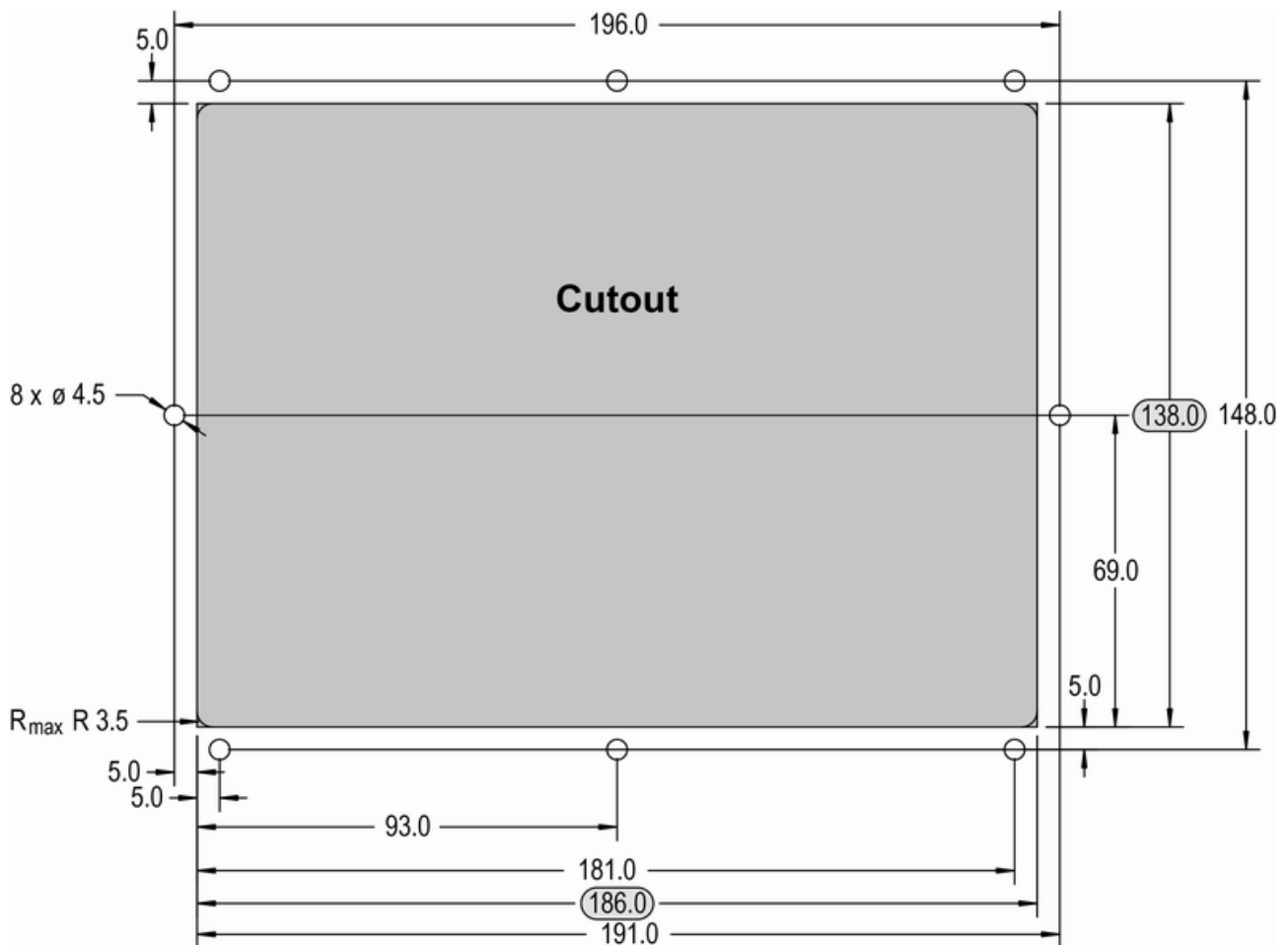

Fig. 18: Plastic housing - drill plan

Special tool: ■ Torque screwdriver

Proceed as follows to install the unit using the screw kit:

1. ➤ Cut out the panel and drill the holes according to the dimensions in Fig. 18 (dimensions shown in mm).
2. ➤ Insert the unit into the panel cutout. Verify that the unit fits correctly in the cutout. If the panel cutout is not big enough, enlarge it accordingly.
3. ➤ Insert the screws and tighten to 0.6 Nm (5.3 pound inches) of torque.



Tighten the screws with a crosswise pattern to ensure even pressure distribution.



If the thickness of the panel sheet exceeds 2.5 mm, be sure to use screws with a length exceeding the panel sheet thickness by 4 mm.

3.3 Setup Connections

General notes



NOTICE!

Malfunctions due to literal use of example values

All technical data and ratings indicated in this chapter are merely listed as examples. Literal use of these values does not take into account all actual specifications of the control unit as delivered.

- For definite values please refer to chapter [Chapter 8 "Technical Specifications"](#) on page 265.

Wire sizes

AWG	mm ²	AWG	mm ²	AWG	mm ²	AWG	mm ²	AWG	mm ²	AWG	mm ²
30	0.05	21	0.38	14	2.5	4	25	3/0	95	600MCM	300
28	0.08	20	0.5	12	4	2	35	4/0	120	750MCM	400
26	0.14	18	0.75	10	6	1	50	300MCM	150	1000MCM	500
24	0.25	17	1.0	8	10	1/0	55	350MCM	185		
22	0.34	16	1.5	6	16	2/0	70	500MCM	240		

Table 3: Conversion chart - wire sizes

3.3.1 Terminal Allocation

General notes

The device terminals are allocated as follows:

- Plastic housing - shown in Fig. 19
- Sheet metal housing - shown in Fig. 20



*Terminal pin 9 is intentionally not available.
Screwable terminals are part of delivery.*



DANGER!

High Voltage! Life-threatening hazards from electric shock!

Take care for installing high voltage mains connection as described in ["Electrical hazards"](#) on page 19.

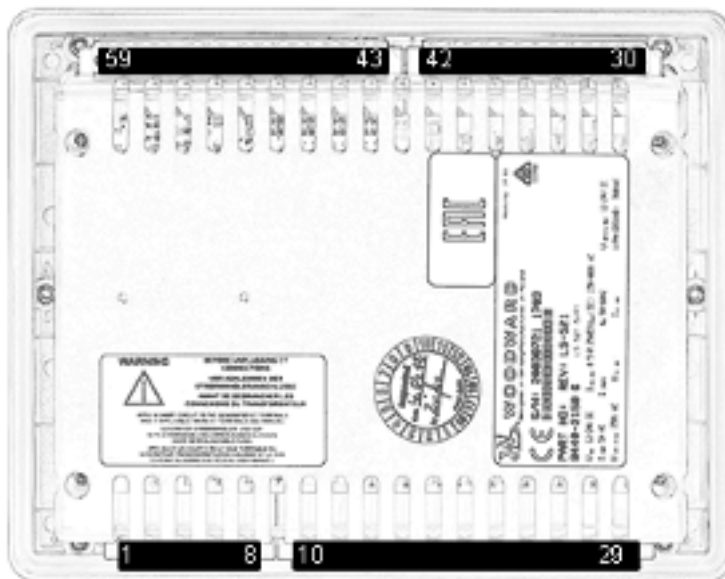

Fig. 19: Plastic housing (rear view)

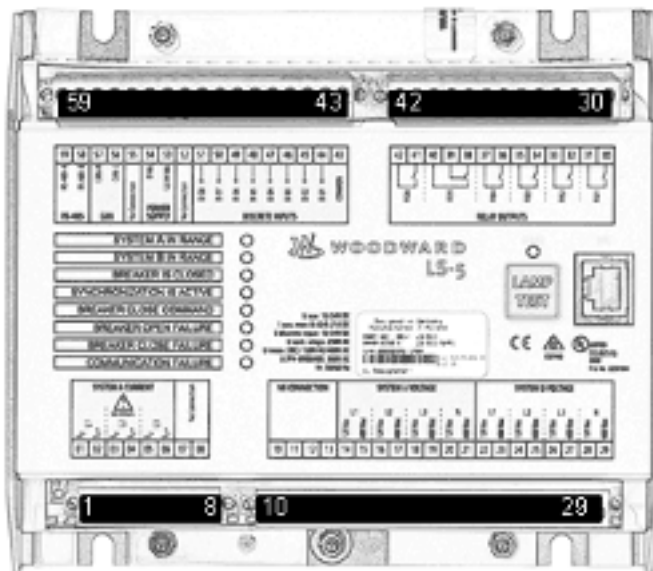



Fig. 20: Sheet metal housing

3.3.2 Wiring Diagram

LS-5x1 v2 Series

The following figure shows the hardware situation. The 2nd drawing offers a functional short description additionally.

 **WARNING!**
Terminal connection of System A current measurement has been changed from the LS-5x1 series devices to the LS-5x1 v2 series devices.

Installation

Setup Connections > Wiring Diagram

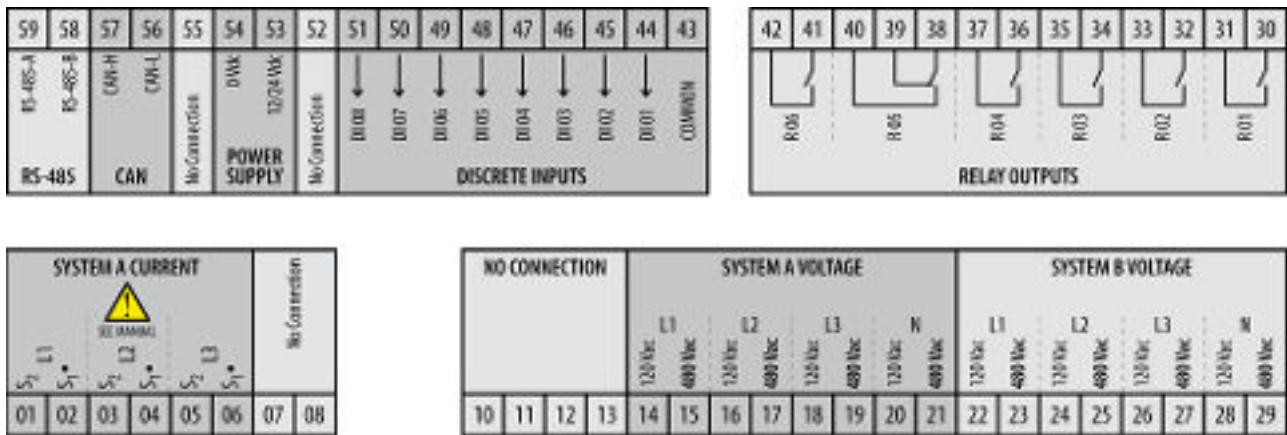













Fig. 21: Label/print LS-5x1 v2 series wiring

			Service port <i>ToolKit</i>			
29	480V _{AC}	System B voltage N		Relay [R1] (isolated)		30
28	120V _{AC}			- Fixed to Ready for operation <i>LogicsManager</i>		31
27	480V _{AC}	System B voltage L3		Relay [R2] (isolated)		32
26	120V _{AC}			Default: Alarm Horn <i>LogicsManager</i>		33
25	480V _{AC}	System B voltage L2		Relay [R3] (isolated)		34
24	120V _{AC}			Default: System B Not OK <i>LogicsManager</i>		35
23	480V _{AC}	System B voltage L1		Relay [R4] (isolated)		36
22	120V _{AC}			Default: System A Not OK <i>LogicsManager</i>		37
21	480V _{AC}	System A voltage N		Relay [R5] (isolated)		38
20	120V _{AC}			- Fixed to Open CB A		39
19	480V _{AC}	System A voltage L3		Relay [R6] (isolated)		40
18	120V _{AC}			- Fixed to Close CB A or <i>LogicsManager</i>		41
17	480V _{AC}	System A voltage L2		DI Common (terminals 44-51)		43
16	120V _{AC}					
15	480V _{AC}	System A voltage L1		Discrete input 1	DI 01	44
14	120V _{AC}					
13		No connection		Discrete input 2	DI 02	45
12						
11		No connection		Discrete input 3	DI 03	46
10						
9		No connection		Discrete input 4	DI 04	47
8						
7		No connection		Discrete input 5	DI 05	48
6						
5	S ₁ ● L3	System A current (isolated)		Discrete input 6	DI 06	49
4	S ₂					
3	S ₁ ● L2	System A current (isolated)		Discrete input 7	DI 07	50
2	S ₂					
1	S ₁ ● L1	System A current (isolated)		Discrete input 8	DI 08	51
	S ₂					
			No connection			52
			Power supply		12/24 V _{DC}	53
			8 to 40 V _{DC}		0 V _{DC}	54
			Function Earth (Display version only)			55
			CAN bus (isolated)		CAN-L	56
					CAN-H	57
			RS-485 interface (isolated)		RS-485-b	58
					RS-485-a	59

LS-5x1

Fig. 22: Wiring diagram (LS-5x1 v2 series)

3.3.3 Power Supply

General notes



WARNING!

Risk of electric shock - plastic housing

- Connect Function Earth to the unit to avoid the risk of electric shock. Setup the connection using screw-plug-terminal 55.
- The conductor providing the connection must have a wire larger than or equal to 2.5 mm² (14 AWG). The connection must be performed properly.



WARNING!

Risk of electric shock - sheet metal housing

- Connect Protective Earth (PE) to the unit to avoid the risk of electric shock. Use the protective earth (PE) connector located at the bottom center of the sheet metal housing.
- The conductor providing the connection must have a wire larger than or equal to 2.5 mm² (14 AWG). The connection must be performed properly.



Woodward recommends to use one of the following slow-acting protective devices in the supply line to terminal 53:

- Fuse NEOZED D01 6A or equivalent **or**
- Miniature Circuit Breaker 6A / Type C
(for example: ABB type: S271C6 or equivalent)

Schematic and terminals

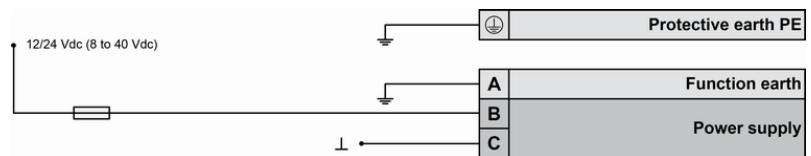

Fig. 23: Power supply - wiring

Terminal	Description	A _{max}
A	55 Function earth (LS-52x models only)	2.5 mm ²
B	53 12/24Vdc (8 to 40.0 Vdc)	2.5 mm ²
C	54 0 Vdc	2.5 mm ²

Table 4: Power supply - terminal assignment

Characteristics

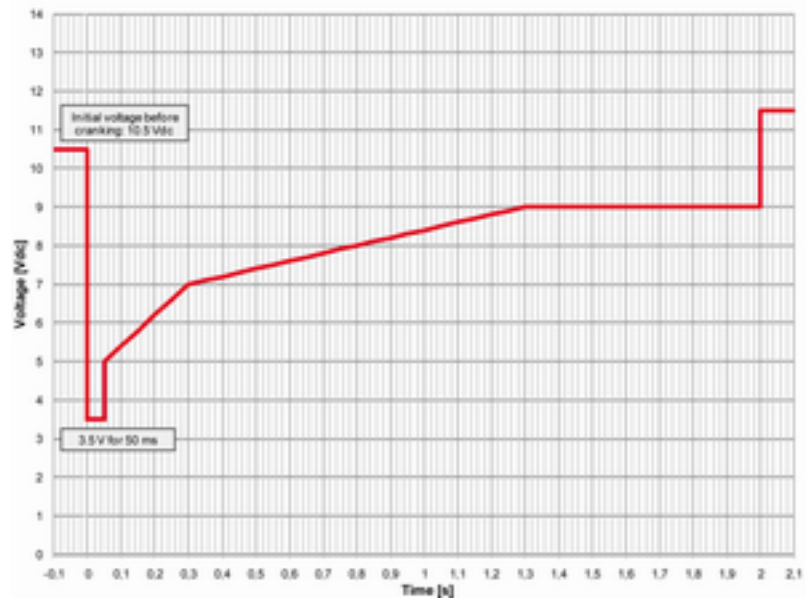

Fig. 24: Power supply - crank waveform

3.3.4 Voltage Measuring

General notes



NOTICE!

Incorrect readings due to improper setup

The control unit will not measure voltage correctly if the 120 V and 480 V inputs are utilized simultaneously.

- Never use both sets of voltage measuring inputs.



Woodward recommends protecting the voltage measuring inputs with slow-acting fuses rated for 2 to 6 A.

3.3.4.1 Isolation switch location

The LS-5x1 v2 can be used in different applications. The following examples show the three basic ones.

Isolation switch on System A side

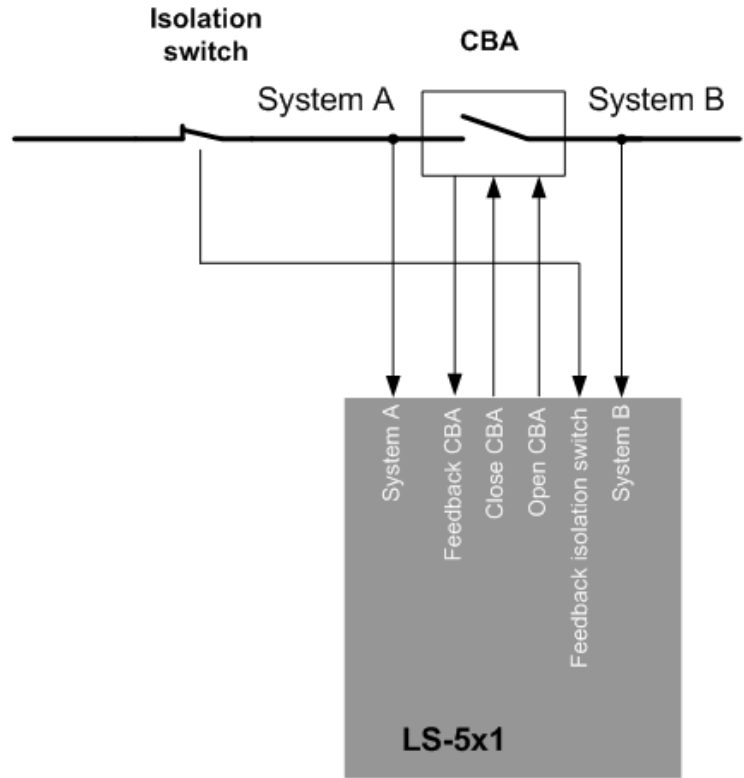

Fig. 25: LS-5x1 v2 - Isolation switch on System A side (example)

Isolation switch on System B side

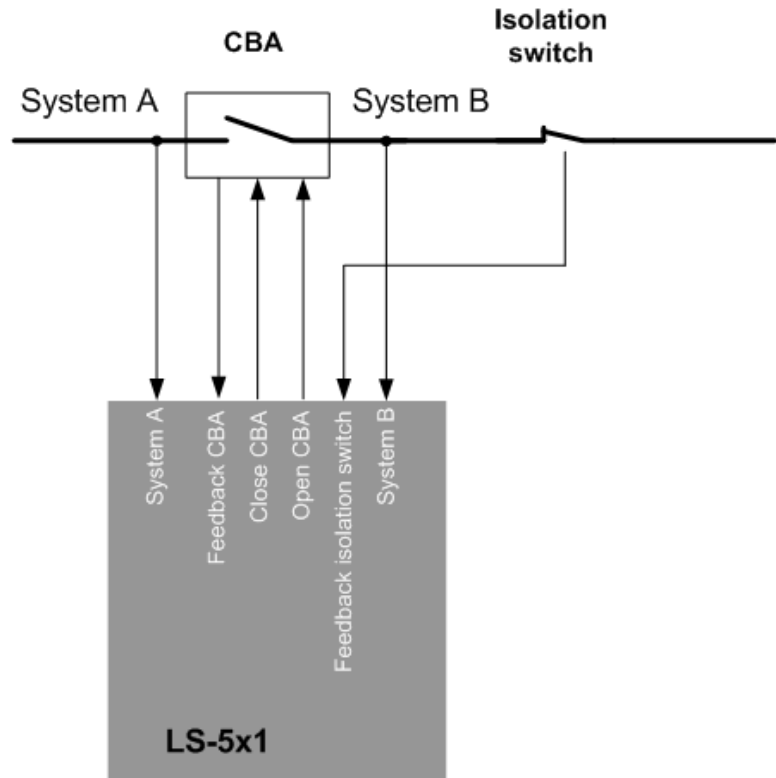

Fig. 26: LS-5x1 v2 - Isolation switch on System B side (example)

No isolation switch

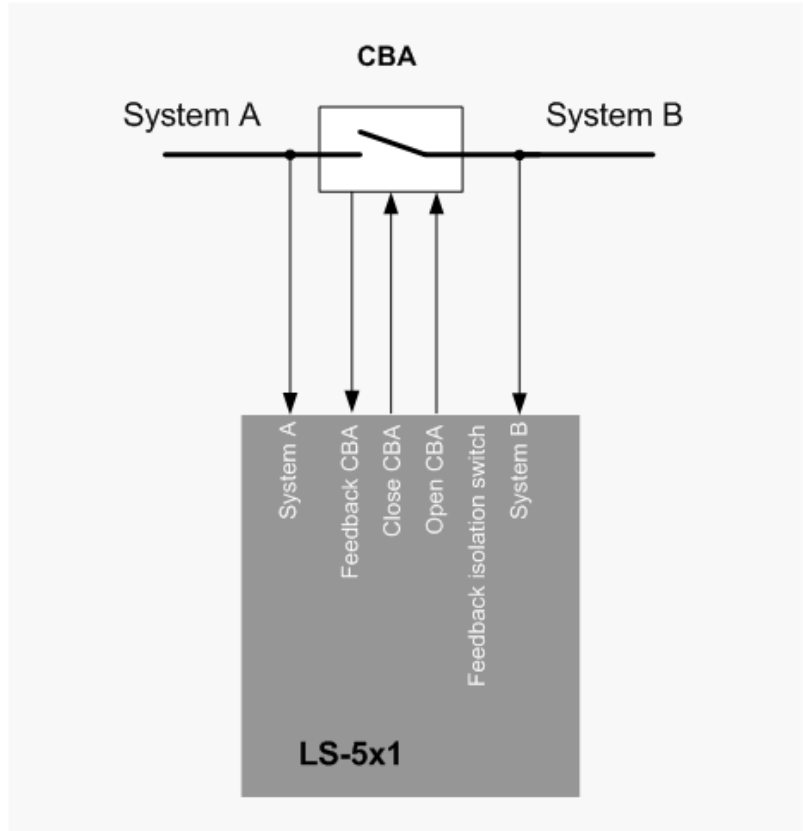

Fig. 27: LS-5x1 v2 - No isolation switch (example)

3.3.4.2 System A Voltage

General notes



If parameter 1800 ↪ p. 78 ("SyA PT secondary rated volt.") is configured with a value between 50 and 130 V, the 120 V input terminals must be used for proper measurement.

If parameter 1800 ↪ p. 78 ("SyA PT secondary rated volt.") is configured with a value between 131 and 480 V, the 480 V input terminals must be used for proper measurement.

Schematic and terminals

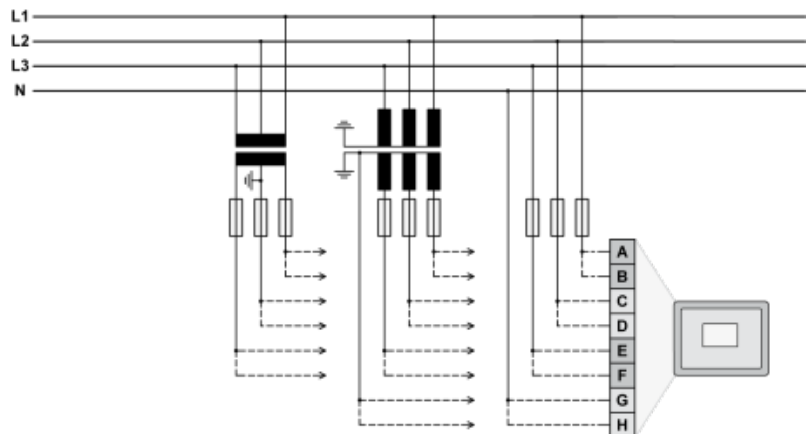

Fig. 28: Voltage measuring - system A - wiring

Terminal		Description		A _{max}
A	14	System A voltage - L1	120 Vac	2.5 mm ²
B	15		480 Vac	2.5 mm ²
C	16	System A voltage - L2	120 Vac	2.5 mm ²
D	17		480 Vac	2.5 mm ²
E	18	System A voltage - L3	120 Vac	2.5 mm ²
F	19		480 Vac	2.5 mm ²
G	20	System A voltage - N	120 Vac	2.5 mm ²
H	21		480 Vac	2.5 mm ²

Table 5: Voltage measuring - system A - terminal assignment

3.3.4.2.1 Parameter Setting '3Ph 4W OD' (3-phase, 4-wire, Open delta)

System A windings

A system that is connected to the load through a 3-phase, 4-wire connection but have the device wired for a 3-phase, 3-wire installation may have the L2 phase grounded on the secondary side. In this application the device will be configured for 3-phase, 4-wire OD for correct power measurement.

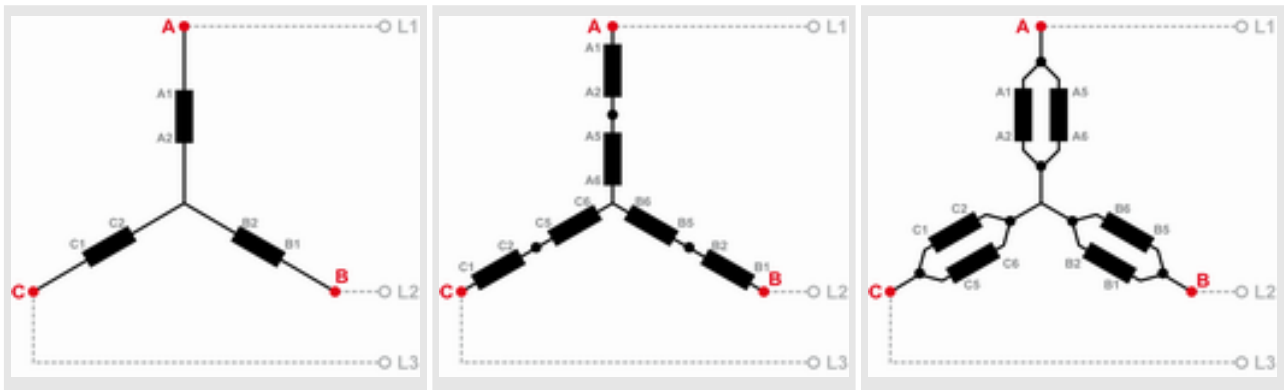

Table 6: System A windings - 3Ph 4W OD

Measuring inputs

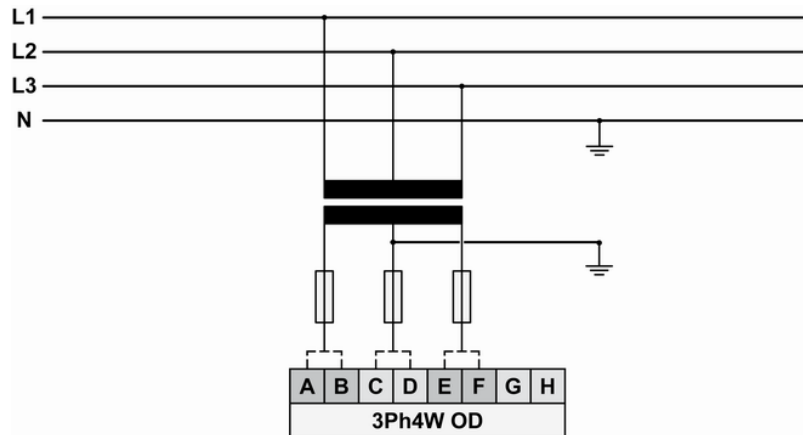

Fig. 29: Measuring inputs - 3Ph 4W OD

Terminal assignment

3Ph 4W	Wiring terminals							
Rated voltage (range)	120 V (50 to 130 V _{eff.})				480 V (131 to 480 V _{eff.})			
Measuring range (max.)	0 to 150 Vac				0 to 600 Vac			
Terminal	A	C	E	G	B	D	F	H
	14	16	18	20	15	17	19	21
Phase	L1	L2	L3	---	L1	L2	L3	---



For different voltage systems, different wiring terminals have to be used.

3.3.4.2.2 Parameter Setting '3Ph 4W' (3-phase, 4-wire)

System A windings

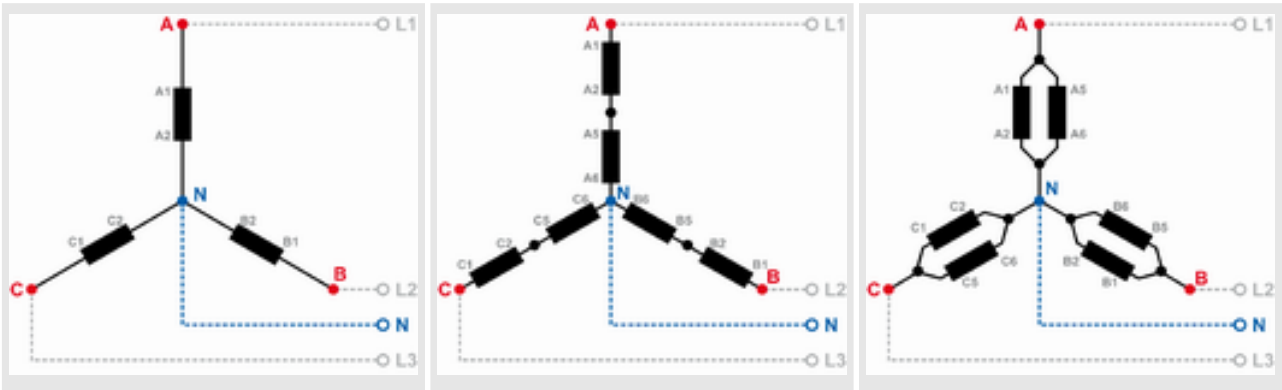

Table 7: System A windings - 3Ph 4W

Measuring inputs

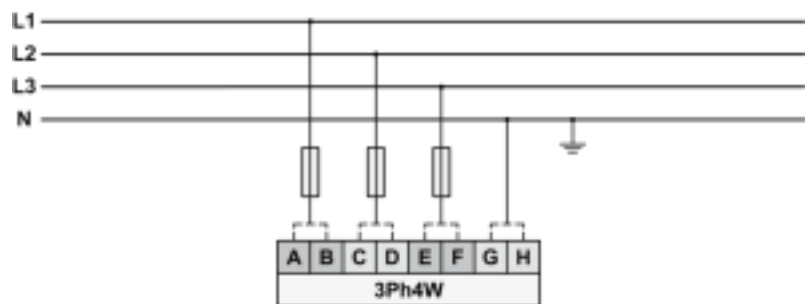

Fig. 30: Measuring inputs - 3Ph 4W

Terminal assignment

3Ph 4W	Wiring terminals							
Rated voltage (range)	120 V (50 to 130 V _{eff.})				480 V (131 to 480 V _{eff.})			
Measuring range (max.)	0 to 150 Vac				0 to 600 Vac			
Terminal	A	C	E	G	B	D	F	H

Installation

3Ph 4W	Wiring terminals							
	14	16	18	20	15	17	19	21
Phase	L1	L2	L3	N	L1	L2	L3	N



For different voltage systems, different wiring terminals have to be used.

Incorrect measurements are possible, if both voltage systems use the same N terminal.

3.3.4.2.3 Parameter Setting '3Ph 3W' (3-phase, 3-wire)

System A windings

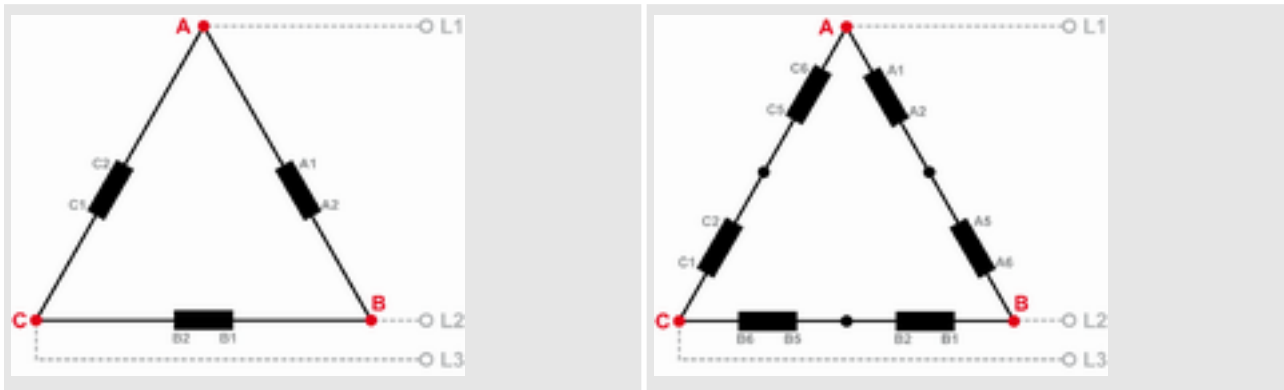

Table 8: System A windings - 3Ph 3W

Measuring inputs

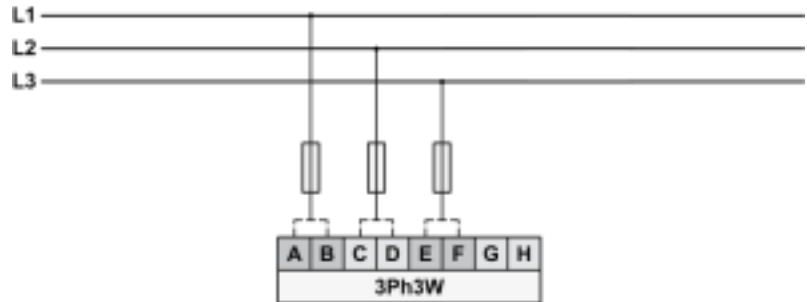

Fig. 31: Measuring inputs - 3Ph 3W

Terminal assignment

3Ph 3W	Wiring terminals							
Rated voltage (range)	120 V (50 to 130 V _{eff.})				480 V (131 to 480 V _{eff.})			
Measuring range (max.)	0 to 150 Vac				0 to 600 Vac			
Terminal	A	C	E	G	B	D	F	H
	14	16	18	20	15	17	19	21
Phase	L1	L2	L3	---	L1	L2	L3	---



For different voltage systems, different wiring terminals have to be used.

3.3.4.2.4 Parameter Setting '1Ph 3W' (1-phase, 3-wire)

System A windings

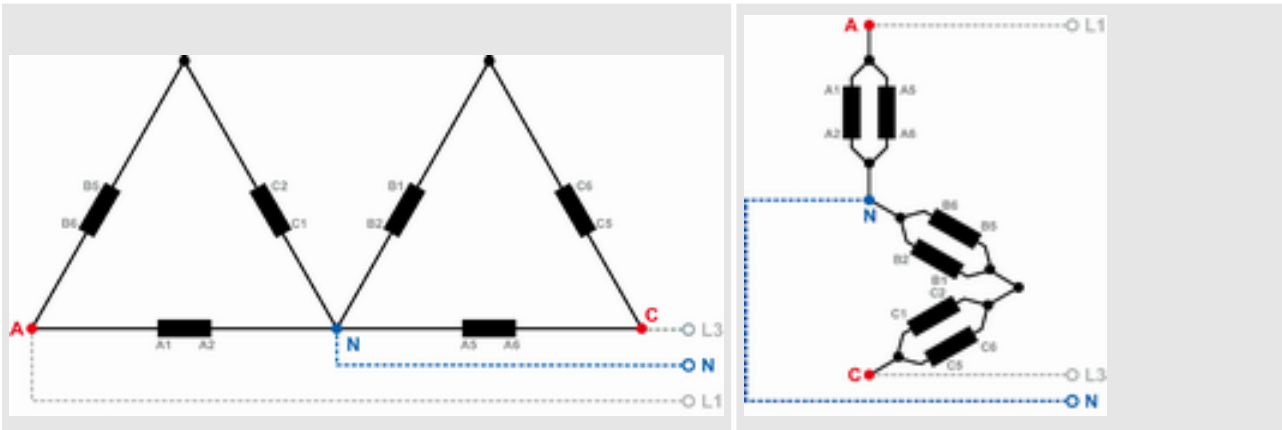

Table 9: System A windings - 1Ph 3W

Measuring inputs

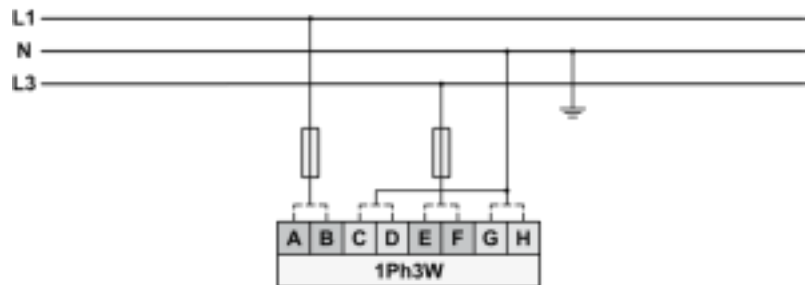

Fig. 32: Measuring inputs - 1Ph 3W

Terminal assignment

1Ph 3W	Wiring terminals							
	Rated voltage (range)	120 V (50 to 130 V _{eff.})				480 V (131 to 480 V _{eff.})		
Measuring range (max.)	0 to 150 Vac				0 to 600 Vac			
Terminal	A	C	E	G	B	D	F	H
	14	16	18	20	15	17	19	21
Phase	L1	N	L3	N	L1	N	L3	N



For different voltage systems, different wiring terminals have to be used.

Incorrect measurements are possible, if both voltage systems use the same N terminal.

3.3.4.2.5 Parameter Setting '1Ph 2W' (1-phase, 2-wire)



The 1-phase, 2-wire measurement may be performed **phase-neutral** or **phase-phase**.

- Please note to configure and wire the LS-5 consistently.

'1Ph 2W' Phase-Neutral Measuring

System A windings

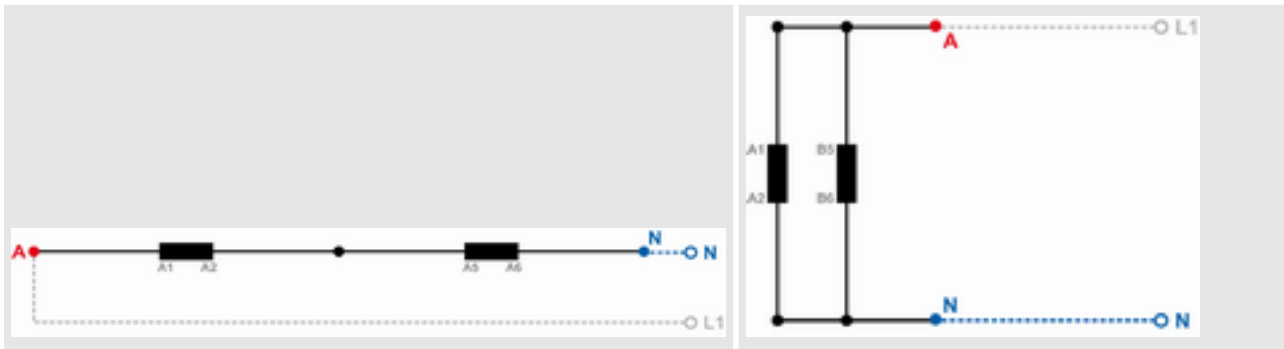

Table 10: System A windings - 1Ph 2W (phase neutral)

Measuring inputs

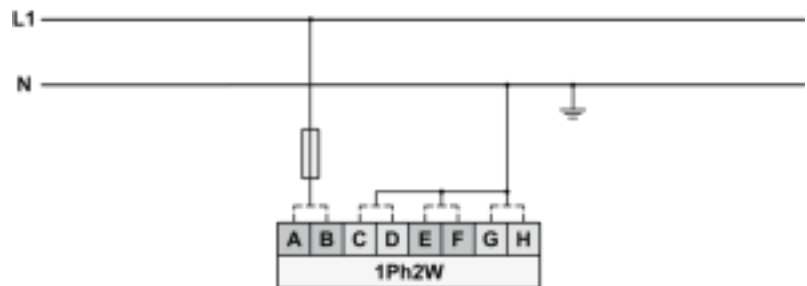

Fig. 33: Measuring inputs - 1Ph 2W (phase neutral)

Terminal assignment

1Ph 2W	Wiring terminals							
Rated voltage (range)	120 V (50 to 130 V _{eff.})				480 V (131 to 480 V _{eff.})			
Measuring range (max.)	0 to 150 Vac				0 to 600 Vac			
Terminal	A	C	E	G	B	D	F	H
	14	16	18	20	15	17	19	21
Phase	L1	N	N	N	L1	N	N	N



For different voltage systems, different wiring terminals have to be used.

Incorrect measurements are possible if both voltage systems use the same N terminal.

'1Ph 2W' Phase-Phase Measuring
System A windings

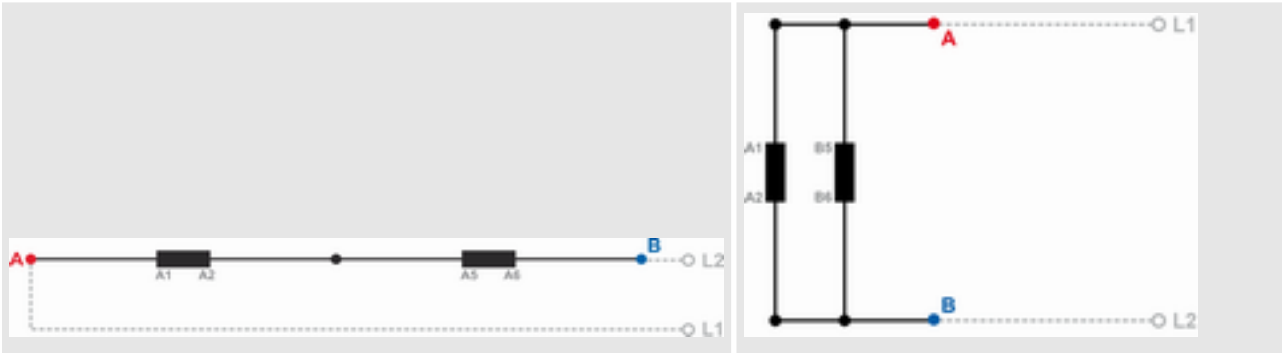

Table 11: System A windings - 1Ph 2W (phase-phase)

Measuring inputs

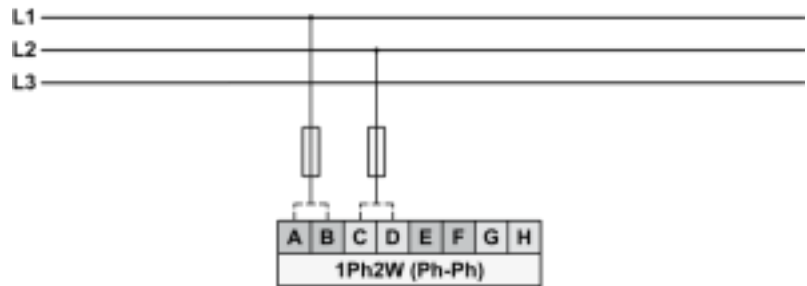

Fig. 34: Measuring inputs - 1Ph 2W (phase-phase)

Terminal assignment

1Ph 2W	Wiring terminals							
	Rated voltage (range)	120 V (50 to 130 V _{eff.})				480 V (131 to 480 V _{eff.})		
Measuring range (max.)	0 to 150 Vac				0 to 600 Vac			
Terminal	A	C	E	G	B	D	F	H
	14	16	18	20	15	17	19	21
Phase	L1	L2	---	---	L1	L2	---	---



For different voltage systems, different wiring terminals have to be used.

3.3.4.3 System B Voltage

General notes



If parameter 1803 ↻ p. 79 ("SyB PT secondary rated volt.") is configured with a value between 50 and 130 V, the 120 V input terminals must be used for proper measurement.

If parameter 1803 ↻ p. 79 ("SyB PT secondary rated volt.") is configured with a value between 131 and 480 V, the 480 V input terminals must be used for proper measurement.

Schematic and terminals

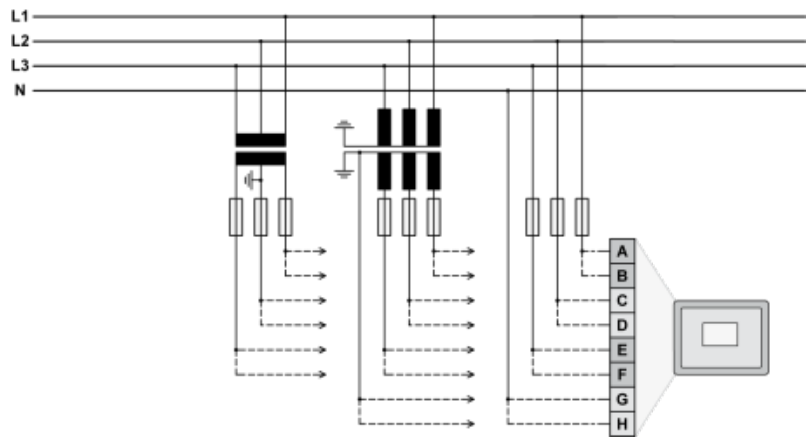

Fig. 35: Voltage measuring - system B - wiring

Terminal	Description	A_{max}
A	System B voltage - L1	120 Vac
B		480 Vac
C	System B voltage - L2	120 Vac
D		480 Vac
E	System B voltage - L3	120 Vac
F		480 Vac
G	System B voltage - N	120 Vac
H		480 Vac

Table 12: Voltage measuring - system B - terminal assignment

3.3.4.3.1 Parameter Setting '3Ph 4W' (3-phase, 4-wire)

System B windings

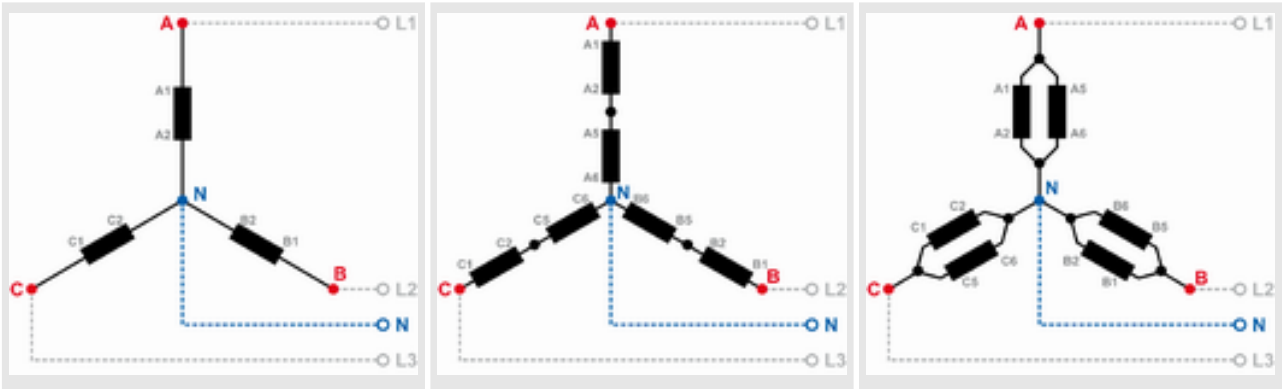

Table 13: System B windings - 3Ph 4W

Measuring inputs

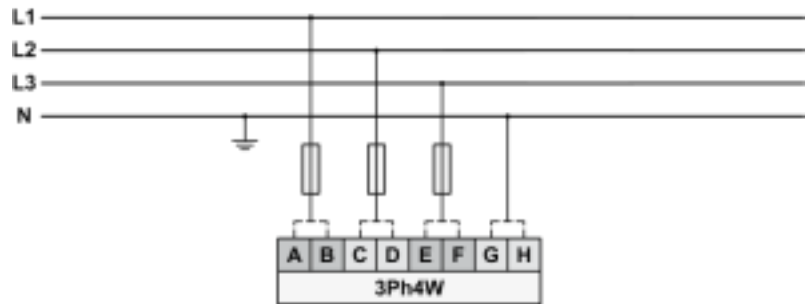

Fig. 36: Measuring inputs - 3Ph 4W

Terminal assignment

3Ph 4W	Wiring terminals							
	Rated voltage (range)	120 V (50 to 130 V _{eff.})				480 V (131 to 480 V _{eff.})		
Measuring range (max.)	0 to 150 Vac				0 to 600 Vac			
Terminal	A	C	E	G	B	D	F	H
	22	24	26	28	23	25	27	29
Phase	L1	L2	L3	N	L1	L2	L3	N



For different voltage systems, different wiring terminals have to be used.

Incorrect measurements are possible if both voltage systems use the same N terminal.

3.3.4.3.2 Parameter Setting '3Ph 3W' (3-phase, 3-wire)

System B windings

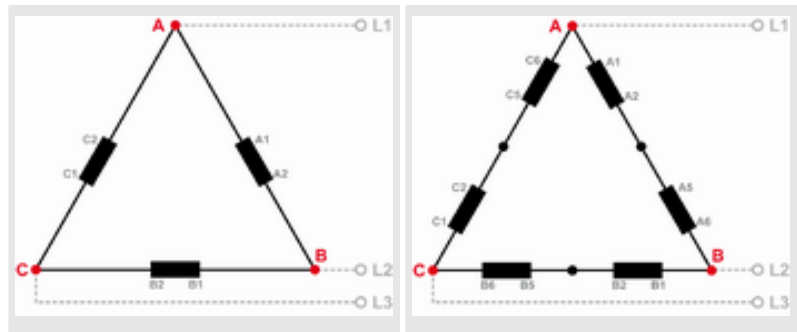

Table 14: System B windings - 3Ph 3W

Measuring inputs

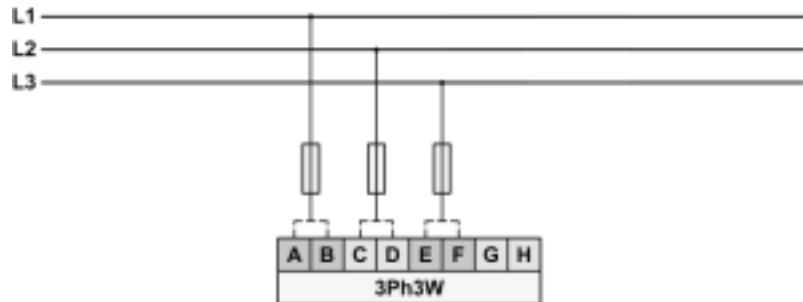

Fig. 37: Measuring inputs - 3Ph 3W

Terminal assignment

3Ph 3W	Wiring terminals							
	Rated voltage (range)	120 V (50 to 130 V _{eff.})				480 V (131 to 480 V _{eff.})		
Measuring range (max.)	0 to 150 Vac				0 to 600 Vac			
Terminal	A	C	E	G	B	D	F	H
	22	24	26	28	23	25	27	29
Phase	L1	L2	L3	---	L1	L2	L3	---



For different voltage systems, different wiring terminals have to be used.

3.3.4.3.3 Parameter Setting '1Ph 3W' (1-phase, 3-wire)

System B windings

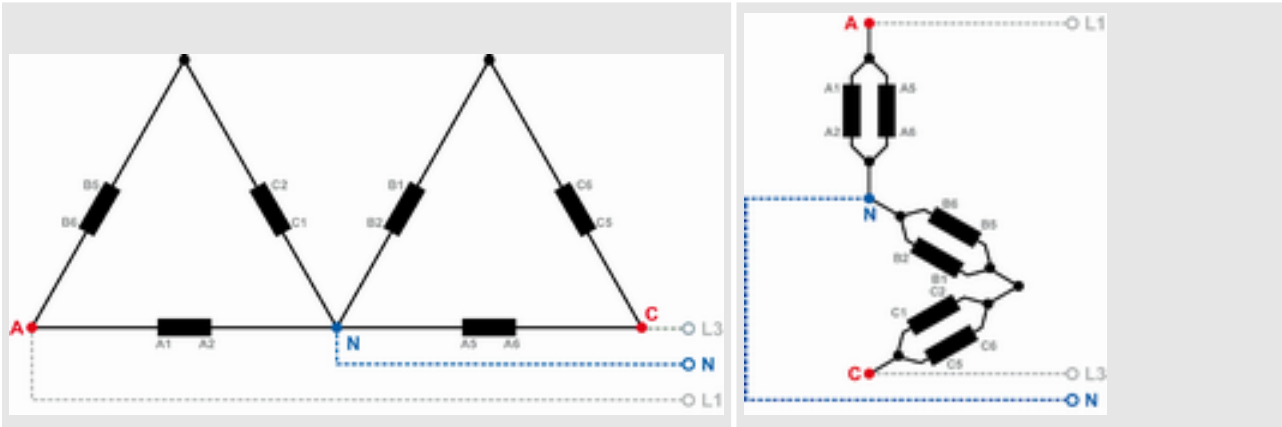

Table 15: System B windings - 1Ph 3W

Measuring inputs

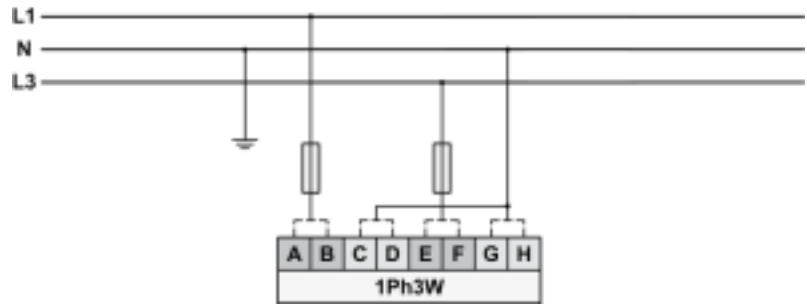

Fig. 38: Measuring inputs - 1Ph 3W

Terminal assignment

1Ph 3W	Wiring terminals							
Rated voltage (range)	120 V (50 to 130 V _{eff.})				480 V (131 to 480 V _{eff.})			
Measuring range (max.)	0 to 150 Vac				0 to 600 Vac			
Terminal	A	C	E	G	B	D	F	H
	22	24	26	28	23	25	27	29
Phase	L1	N	L3	N	L1	N	L3	N



For different voltage systems, different wiring terminals have to be used.

Incorrect measurements are possible, if both voltage systems use the same N terminal.

3.3.4.3.4 Parameter Setting '1Ph 2W' (1-phase, 2-wire)



The 1-phase, 2-wire measurement may be performed **phase-neutral** or **phase-phase**.

- Please note to configure and wire the easYgen consistently.

'1Ph 2W' Phase-Neutral Measuring

System B windings

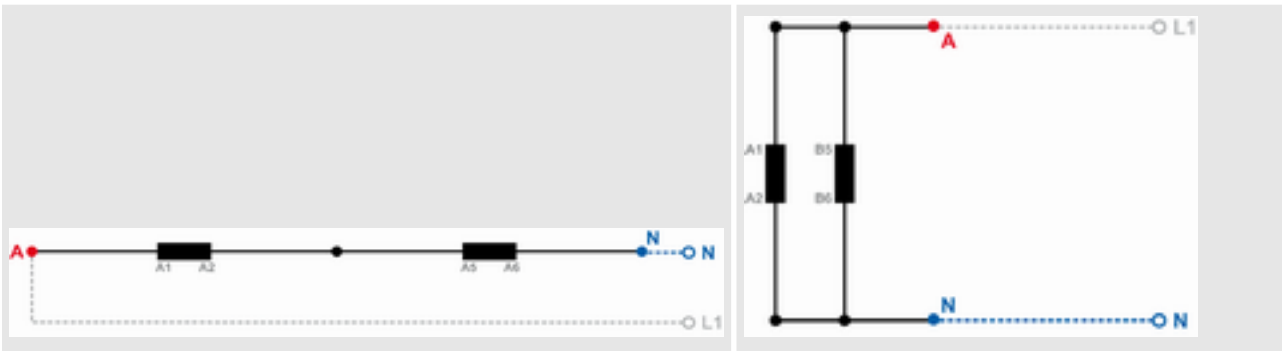

Table 16: System B windings - 1Ph 2W (phase neutral)

Measuring inputs

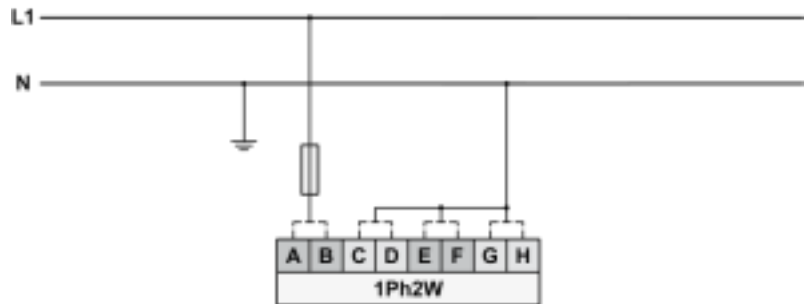

Fig. 39: Measuring inputs - 1Ph 2W (phase neutral)

Terminal assignment

1Ph 2W	Wiring terminals							
Rated voltage (range)	120 V (50 to 130 V _{eff.})				480 V (131 to 480 V _{eff.})			
Measuring range (max.)	0 to 150 Vac				0 to 600 Vac			
Terminal	A	C	E	G	B	D	F	H
	22	24	26	28	23	25	27	29
Phase	L1	N	N	N	L1	N	N	N



For different voltage systems, different wiring terminals have to be used.

Incorrect measurements are possible, if both voltage systems use the same N terminal.

'1Ph 2W' Phase-Phase Measuring

System B windings

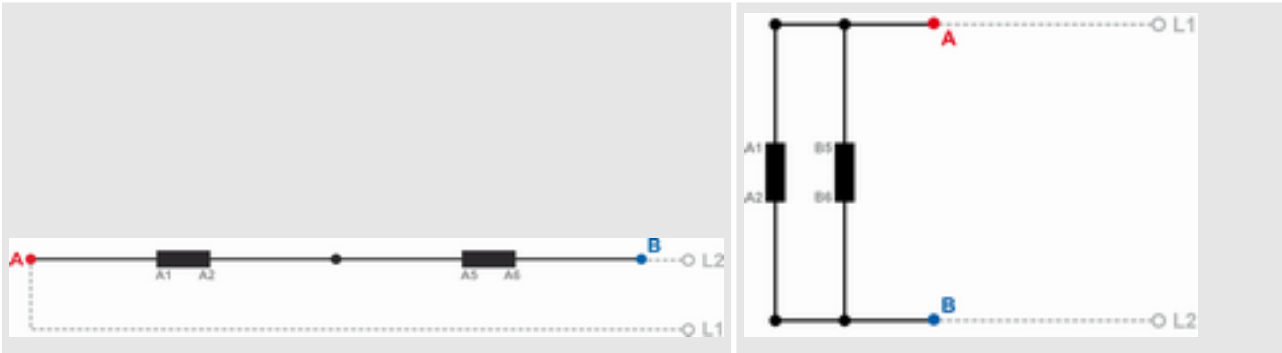

Table 17: System B windings - 1Ph 2W (phase-phase)

Measuring inputs

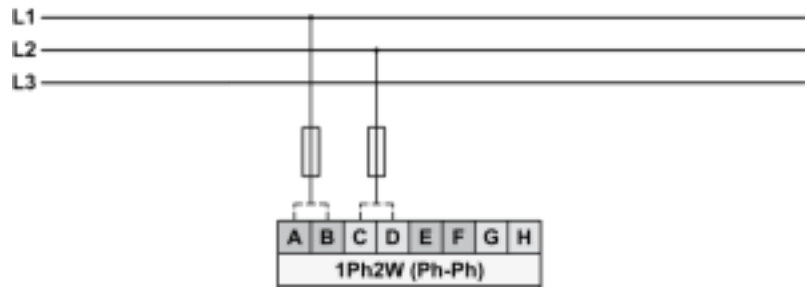

Fig. 40: Measuring inputs - 1Ph 2W (phase-phase)

Terminal assignment

1Ph 2W	Wiring terminals							
	Rated voltage (range)	120 V (50 to 130 V _{eff.})				480 V (131 to 480 V _{eff.})		
Measuring range (max.)	0 to 150 Vac				0 to 600 Vac			
Terminal	A	C	E	G	B	D	F	H
	22	24	26	28	23	25	27	29
Phase	L1	L2	---	---	L1	L2	---	---



For different voltage systems, different wiring terminals have to be used.

3.3.5 Current Measuring

Current measuring is available for all three phases of System A.

3.3.5.1 Current Measuring (System A)

General notes



WARNING!

Dangerous voltages due to missing load

- Before disconnecting the device, ensure that the current transformer (CT) is short-circuited.



Generally, one line of the current transformers secondary must be grounded close to the CT.

Schematic and terminals

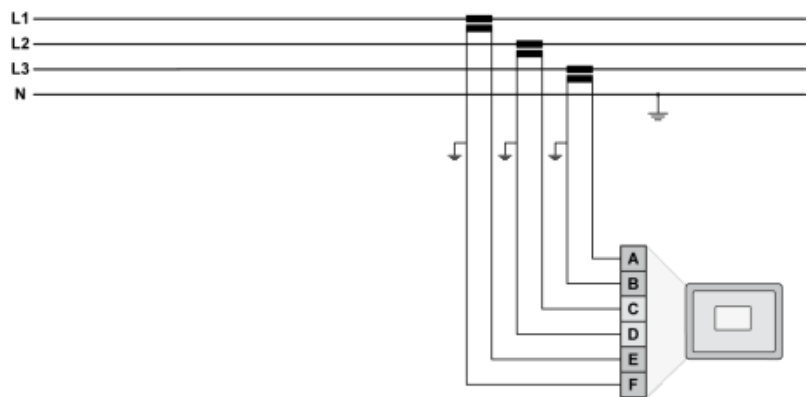

Fig. 41: Current measuring - system A - wiring

Terminal		Description	A _{max}
A	6	System A current - L3	2.5 mm ²
B	5	System A current - L3 (GND)	2.5 mm ²
C	4	System A current - L2	2.5 mm ²
D	3	System A current - L2 (GND)	2.5 mm ²
E	2	System A current - L1	2.5 mm ²
F	1	System A current - L1 (GND)	2.5 mm ²

Table 18: Current measuring - system A - terminal assignment

3.3.5.1.1 Parameter Setting 'L1 L2 L3'

Schematic and terminals

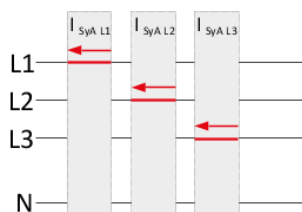

Fig. 42: Current measuring - system A, L1 L2 L3

	Wiring terminals					
	F	E	D	C	B	A
Terminal	1	2	3	4	5	6
Phase L1 L2 L3	s1 (k) L1	s2 (l) L1	s1 (k) L2	s2 (l) L2	s1 (k) L3	s2 (l) L3
Phase L1 and L3	s1 (k) L1	s2 (l) L1	—	—	s1 (k) L3	s2 (l) L3



"Phase L1 and L3" applies if the system A voltage measurement is configured to 1Ph 3W (Chapter 3.3.4.2.4 "Parameter Setting '1Ph 3W' (1-phase, 3-wire)" on page 47).

3.3.5.1.2 Parameter Setting 'Phase L1' 'Phase L2' 'Phase L3'

Schematic and terminals

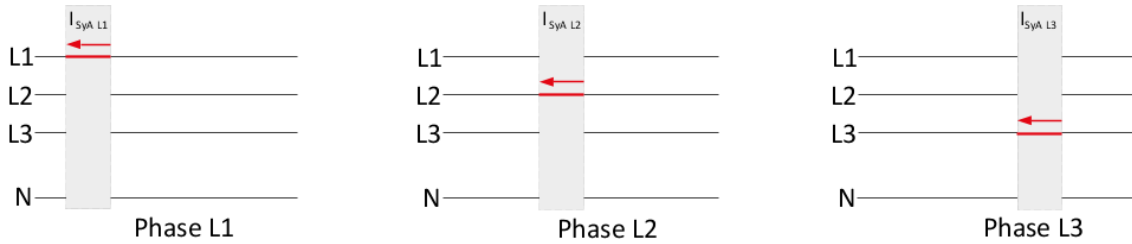

Fig. 43: Current measuring - system A, 'Phase L1' 'Phase L2' 'Phase L3'

	Wiring terminals					
	F	E	D	C	B	A
Terminal	1	2	3	4	5	6
Phase L1	s1 (k) L1	s2 (l) L1	—	—	—	—
Phase L2	—	—	s1 (k) L2	s2 (l) L2	—	—
Phase L3	—	—	—	—	s1 (k) L3	s2 (l) L3

3.3.6 Power Measuring

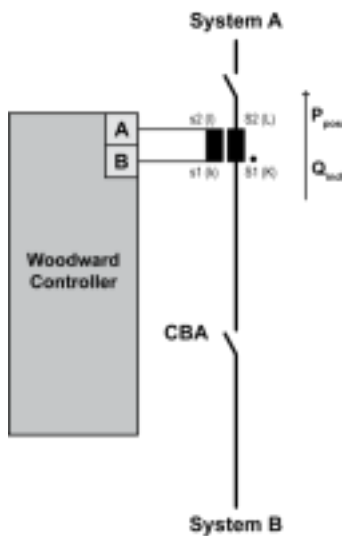

Fig. 44: Power measuring - wiring

If the unit's current transformers are wired according to the diagram (Fig. 44), the following values are displayed.

Terminal	Description			
	L1	L2	L3	
A	2	4	6	System A current
B	1	3	5	

	Description	Sign displayed
Positive real power	Power flow from System B to System A	+ Positive
Inductive (lagging) power flow	Inductive power flow from System B to System A	+ Positive

3.3.7 Power Factor Definition

Definition

Power Factor is defined as a ratio of the real power to apparent power. In a purely resistive circuit, the voltage and current waveforms are instep resulting in a ratio or power factor of 1.00 (often referred to as unity).

In an inductive circuit the current lags behind the voltage waveform resulting in usable power (real power) and unusable power (reactive power). This results in a positive ratio or lagging power factor (i.e. 0.85lagging).

In a capacitive circuit the current waveform leads the voltage waveform resulting in usable power (real power) and unusable power (reactive power). This results in a negative ratio or a leading power factor (i.e. 0.85leading).

Properties

	Inductive	Capacitive
Load type	Electrical load whose current waveform lags the voltage waveform thus having a lagging power factor. Some inductive loads such as electric motors have a large startup current requirement resulting in lagging power factors.	Electrical load whose current waveform leads the voltage waveform thus having a leading power factor. Some capacitive loads such as capacitor banks or buried cable result in leading power factors.
Different power factor display on the unit	i0.91 (inductive) lg.91 (lagging)	c0.93 (capacitive) ld.93 (leading)
Reactive power display on the unit	70 kvar (positive)	-60 kvar (negative)
Output of the interface	+ (positive)	- (negative)
Current relation to voltage	Lagging	Leading
Generator state	Overexcited	Underexcited
Control signal	If the control unit is equipped with a power factor controller while in parallel with the utility:	
	A voltage lower "-" signal is output as long as the measured value is "more inductive" than the reference setpoint Example: measured = i0.91; setpoint = i0.95	A voltage raise "+" signal is output as long as the measured value is "more capacitive" than the reference setpoint Example: measured = c0.91; setpoint = c0.95

Phasor diagram



The phasor diagram is used from the generator's view.

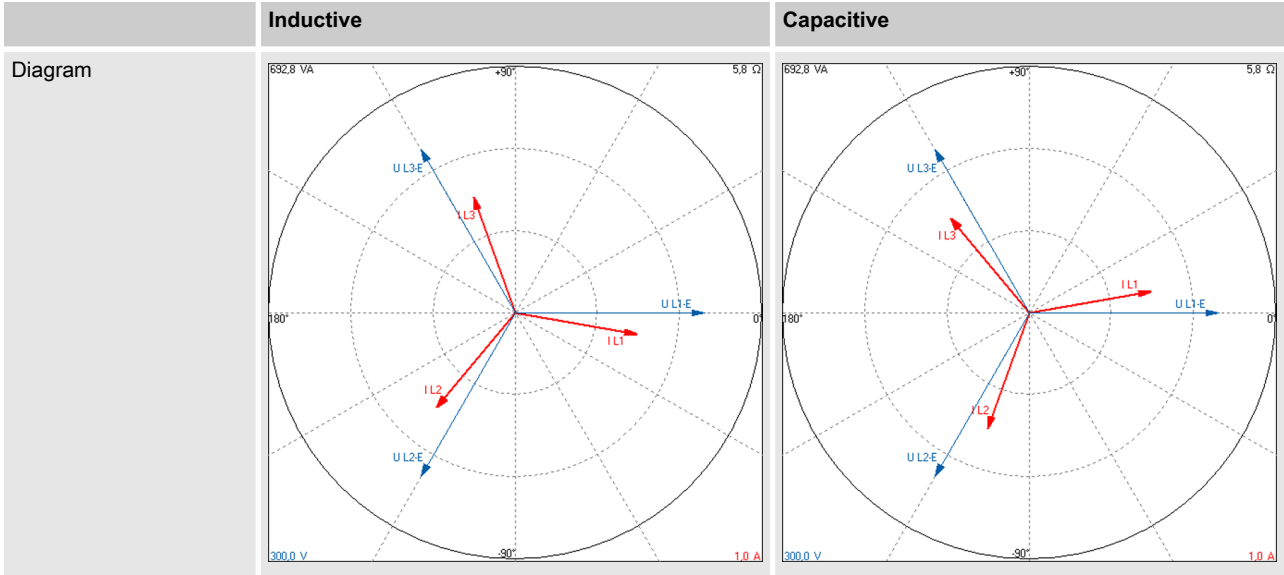

3.3.8 Discrete Inputs

General notes



The discrete inputs are electrically isolated which permits the polarity of the connections to be either positive or negative.

- All discrete inputs must use the same polarity, either positive or negative signals, due to the common ground.

Schematic and terminal assignment



Fig. 45: Discrete input - positive polarity signal



Fig. 46: Discrete input - negative polarity signal

Terminal		Description	A _{max}
A	B		
43	44	Discrete Input [DI 01]	Preconfigured to "Lock monitoring" ¹ 2.5 mm ²
GND	45	Discrete Input [DI 02]	Preconfigured to "Remote acknowledge" ¹ 2.5 mm ²
Common ground	46	Discrete Input [DI 03]	Preconfigured to "Enable decoupling" ¹ 2.5 mm ²

Terminal		Description	A _{max}	
A	B			
	47	Discrete Input [DI 04]	Preconfigured to "Immediate open CBA" ¹	2.5 mm ²
	48	Discrete Input [DI 05]	Preconfigured to "Reply: Isolation switch is open" ¹	2.5 mm ²
	49	Discrete Input [DI 06]	Preconfigured to "Open CBA (with unloading)" ¹	2.5 mm ²
	50	Discrete Input [DI 07]	Preconfigured to "Enable to close CBA" ¹	2.5 mm ²
	51	Discrete Input [DI 08]	Fixed to "Reply: CBA is open"	2.5 mm ²

 – ¹ configurable via LogicsManager

Operation logic

Discrete inputs may be configured to normally open (N.O.) or normally closed (N.C.) states.



Fig. 47: Discrete inputs - state N.O.

In the state N.O., no potential is present during normal operation; if an alarm is issued or control operation is performed, the input is energized.



Fig. 48: Discrete inputs - state N.C.



In the state N.C., a potential is continuously present during normal operation; if an alarm is issued or control operation is performed, the input is de-energized.

The N.O. or N.C. contacts may be connected to the signal terminal as well as to the ground terminal of the discrete input ( "Schematic and terminal assignment" on page 59).

3.3.9 Relay Outputs

General notes

 **CAUTION!**
The relay output "Ready for operation" must be integrated into the alarm chain to make sure that if this relay falls off an appropriate action can be taken.

 For information on interference suppressing circuits when connecting 24 V relays, please refer to  Chapter 3.5 "Connecting 24 V Relays" on page 65.

Schematic and terminals

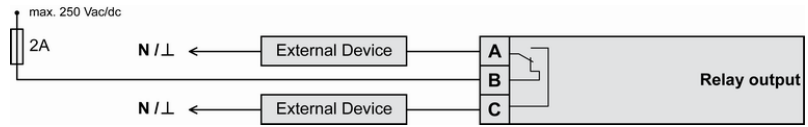

Fig. 49: Relay outputs - schematic

Terminal		Description			A _{max}	
Common	N.O.					
A	C	Form A				
30	31	Relay output [R 01]	All	Fixed to "Ready for operation" ¹	2.5 mm ²	
32	33	Relay output [R 02]	All	Preconfigured to "Horn" ¹	2.5 mm ²	
34	35	Relay output [R 03]	All	Preconfigured to "System B not OK" ¹	2.5 mm ²	
36	37	Relay output [R 04]	All	Preconfigured to "System A not OK" ¹	2.5 mm ²	
41	42	Relay output [R 06]	All	Fixed to "Close CBA" in [CBA: Two relay] mode otherwise preconfigured to "All alarm classes" ¹	2.5 mm ²	

Terminal			Description			A _{max}	
Common	N.C.	N.O.					
A	B	C	Form C				
38	39	40	Relay output [R 05]	All	Fixed to "Open CBA"	2.5 mm ²	



Notes

¹ configurable via LogicsManager



Notes

- **LogicsManager:** Using the function Logics-Manager it is possible to freely program the relays for all application modes.
- **N.O.:** normally open (make) contact
- **N.C.:** normally closed (break) contact

3.3.10 Serial Interface

3.3.10.1 RS-485 Interface

General notes



Please note that the RS-485 interface only operates in half-duplex mode.

Pin assignment

Terminal	Description	A _{max}
58	RS-485-B (TxD-)	N/A
59	RS-485-A (TxD+)	N/A

Table 19: Pin assignment

RS-485 half-duplex

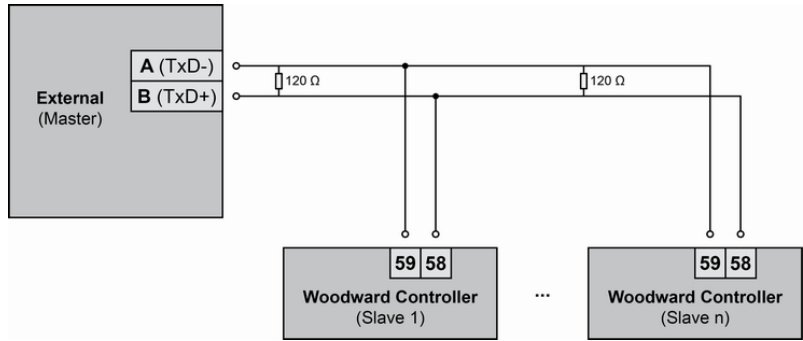

Fig. 50: RS-485 - connection for half-duplex operation

3.3.11 Service Port

Service port connector

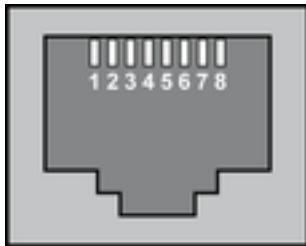

Fig. 51: Service port connector (RJ-45)

The Woodward specific service port is a connector (RJ-45) to extend the interfaces of the controller.

i The service port can be **only** used in combination with an optional Woodward direct configuration cable (DPC).

Direct configuration cable (DPC)

The DPC cable is used to configure the device with the ToolKit configuration software and external extensions/applications.

There are two versions available:

- DPC-USB direct configuration cable
- DPC-RS-232 direct configuration cable

DPC-USB direct configuration cable

Use the DPC-USB direct configuration cable if you want to connect the Woodward controller to an external device (master) which is equipped with an USB port.

Order item number:

- DPC-USB direct configuration cable – P/N 5417-1251

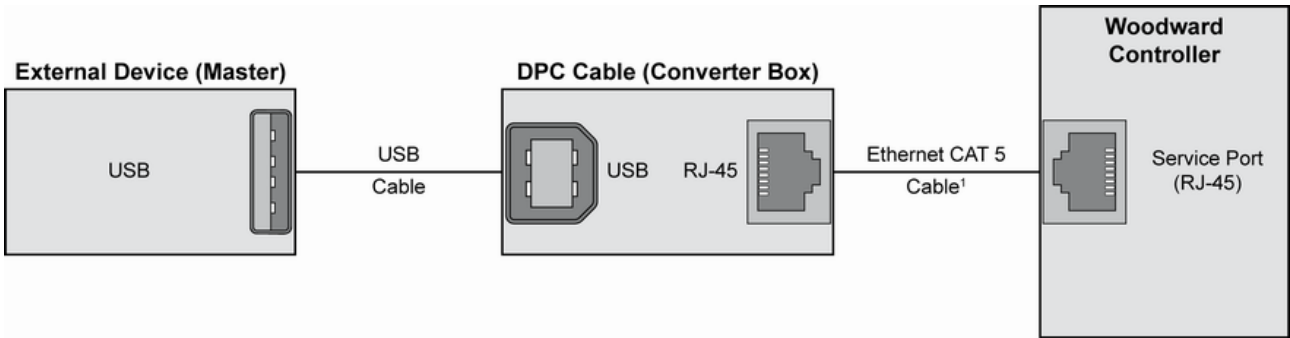

Fig. 52: DPC-USB wiring - schematic



¹ Use the Ethernet CAT 5 cable which is supplied with the DPC-USB converter. The maximum cable length must not exceed 0.5 m.

DPC-RS-232 direct configuration cable

Use the DPC-RS-232 direct configuration cable if you want to connect the Woodward controller to an external device (master) which is equipped with an RS-232 port.

Order item number:

- DPC-RS-232 direct configuration cable – P/N 5417-557

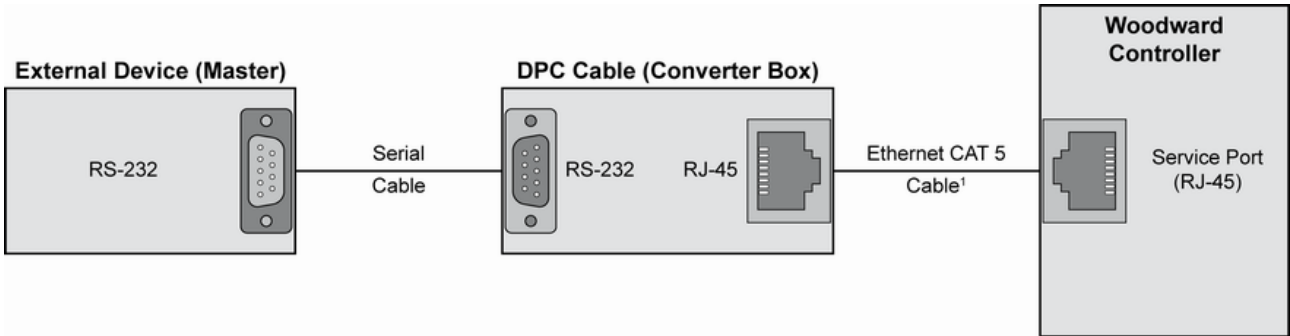

Fig. 53: DPC-RS-232 wiring - schematic



¹ Use the Ethernet CAT 5 cable which is supplied with the DPC-RS-232 converter. The maximum cable length must not exceed 0.5 m.



For a continuous operation with the direct configuration cable DPC-RS-232 (e.g. remote control of controller), it is required to use at least revision F (P/N 5417-557 Rev. F) of the DPC-RS-232. When using a DPC-RS-232 of an earlier revision, problems may occur in continuous operation. The shield connector (6.3 mm tab connector) at the DPC-RS-232 of revision F (P/N 5417-557 Rev. F) and above must be connected to ground.

3.4 CAN Bus Interface

Pin assignment

Terminal	Description	A _{max}
56	CAN-L	N/A
57	CAN-H	N/A

Table 20: Pin assignment

Topology



Please note that the CAN bus must be terminated with a resistor, which corresponds to the impedance of the cable (e.g. 120 Ohms, 1/4 W) at both ends.

The termination resistor is connected between CAN-H and CAN-L (Fig. 54).

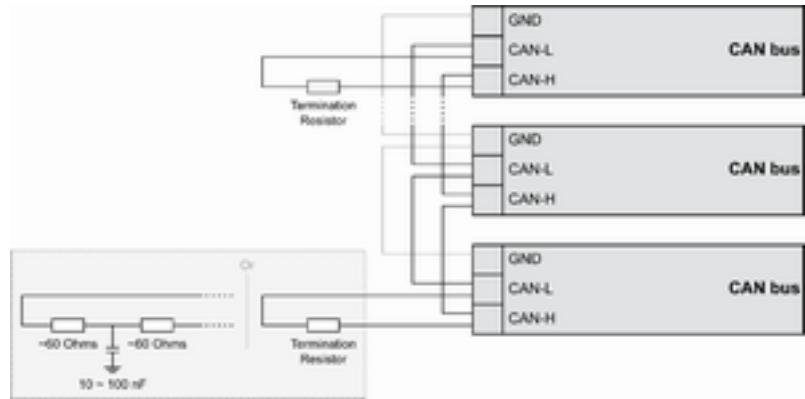

Fig. 54: CAN bus - termination

For very critical EMC conditions (many noise sources with high noise levels) and for high transmission rates we recommend to use the 'Split termination concept' as shown.

- Divide the termination resistance into 2x60 Ohms with a center tap connected to ground via a capacitor of 10 to 100 nF (Fig. 54).

Maximum CAN bus length

The maximum length of the communication bus wiring is dependent on the configured baud rate. Observe the maximum bus length.

(Source: CANopen; Holger Zeltwanger (Hrsg.); 2001 VDE VERLAG GMBH, Berlin und Offenbach; ISBN 3-8007-2448-0).

Baud rate	Max. length
1000 kbit/s	25 m
800 kbit/s	50 m
500 kbit/s	100 m
250 kbit/s	250 m
125 kbit/s	500 m
50 kbit/s	1000 m
20 kbit/s	2500 m

Bus shielding

All bus connections of the easYgen are internally grounded via an RC element. Therefore, they may either be grounded directly (recommended) or also via an RC element on the opposite bus connection.

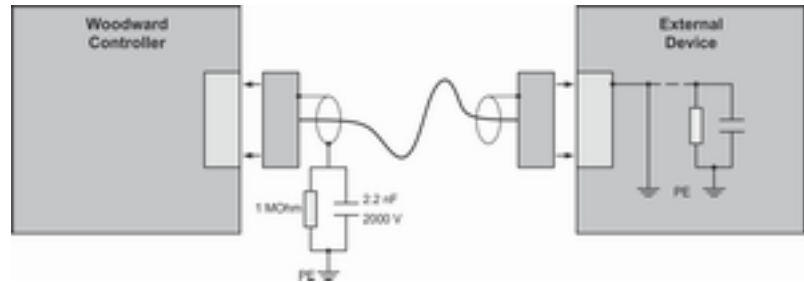

Fig. 55: Bus shielding (external RC element)

Troubleshooting



If data is not transmitting on the CAN bus, check the for the following common CAN bus communication problems:

- A T-structure bus is utilized
- CAN-L and CAN-H are switched
- Not all devices on the bus are using identical baud rates
- Termination resistor(s) are missing
- The configured baud rate is too high for wiring length
- The CAN bus cable is routed in close proximity with power cables



Woodward recommends the use of shielded, twisted-pair cables for the CAN bus (see examples).

- Lappkabel Unitronic LIYCY (TP) 2×2×0.25
- UNITRONIC-Bus LD 2×2×0.22

3.5 Connecting 24 V Relays



NOTICE!

Damage to adjacent electronic components due to induced voltages

- Implement protection circuits as detailed below.

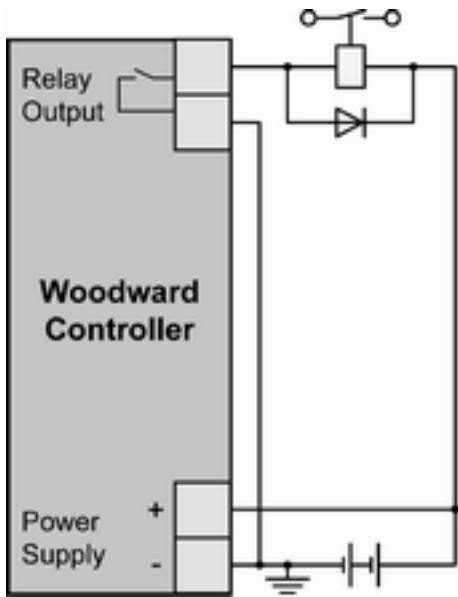

Interferences in the interaction of all components may affect the function of electronic devices. One interference factor is disabling inductive loads, like coils of electromagnetic switching devices.

When disabling such a device, high switch-off induced voltages may occur, which might destroy adjacent electronic devices or result interference voltage pulses, which lead to functional faults, by capacitive coupling mechanisms.

Since an interference-free switch-off is not possible without additional equipment, the relay coil is connected with an interference suppressing circuit.

If 24 V (coupling) relays are used in an application, it is required to connect a protection circuit to avoid interferences.



Fig. 56 shows the exemplary connection of a diode as an interference suppressing circuit.

Fig. 56: Protection circuit (example)

Advantages and disadvantages of different interference suppressing circuits are as follows:

Connection diagram	Load current / voltage curve	Advantages	Disadvantages
		<ul style="list-style-type: none"> Uncritical dimensioning Lowest possible induced voltage Very simple and reliable 	<ul style="list-style-type: none"> High release delay
		<ul style="list-style-type: none"> Uncritical dimensioning High energy absorption Very simple setup Suitable for AC voltage Reverse polarity protected 	<ul style="list-style-type: none"> No attenuation below VVDR
		<ul style="list-style-type: none"> HF attenuation by energy storage Immediate shut-off limiting Attenuation below limiting voltage Very suitable for AC voltage Reverse polarity protected 	<ul style="list-style-type: none"> Exact dimensioning required

4 Configuration

All parameters are assigned a unique parameter identification number.

The parameter identification number may be used to reference individual parameters listed in this manual.



This parameter identification number is also displayed in the ToolKit configuration screens next to the respective parameter.



*If an LS-5x2 v2 is configured as an LS-5x1 v2, there are LS-5x2 v2 LogicsManager command variables available for configuration but cannot be used. All LogicsManager command variables of the LS-5x1 v2 are listed in the following table:
↳ Chapter 9.3.4 “Logical Command Variables” on page 360.*

4.1 Basic Setup

4.1.1 Configure Language/Clock

General notes

The following parameters are used to set the unit language, the current date and time, and the daylight saving time feature.



If an Asian language is configured, some parameter screens may be displayed with an empty space at the bottom of the parameter list, which may be interpreted as an end of the list, although more parameters exist and are displayed when scrolling down.

ID	Parameter	CL	Setting range [Default]	Description
1700	Language (Set language)	0	selectable languages [English]	The desired language for the unit display text is configured here. One of eleven languages can be selected: English, Deutsch, Polski, Italiano, French, Spanish, Turkish, Russian, Chinese, Portuguese, Japanese
1710	Hour	0	hour 0 to 23 h [real-time clock]	The hour of the clock time is set here. Example ■ 0 = 0th hour of the day (midnight). ■ 23 = 23rd hour of the day (11 pm).
1709	Minute	0	0 to 59 min [real-time clock]	The minute of the clock time is set here. Example ■ 0 = 0th minute of the hour ■ 59 = 59th minute of the hour
1708	Second	0	0 to 59 s [real-time clock]	The second of the clock time is set here.

Configuration

Basic Setup > Configure Language/Clock

ID	Parameter	CL	Setting range [Default]	Description
				Example <ul style="list-style-type: none"> ■ 0 = 0th second of the minute ■ 59 = 59th second of the minute
1698	Transfer time to clock	0	Yes	Adjusted time will be transferred to the unit.
			No	Adjusted time will be not transferred to the unit.
				Notes This parameter may only be configured using ToolKit.
1711	Day	0	day 1 to 31 [real-time clock]	The day of the date is set here. Example <ul style="list-style-type: none"> ■ 1 = 1st day of the month. ■ 31 = 31st day of the month.
			month 1 to 12 [real-time clock]	The month of the date is set here. Example <ul style="list-style-type: none"> ■ 1 = 1st month of the year. ■ 12 = 12th month of the year.
1712	Month	0	year 0 to 99 [real-time clock]	The year of the date is set here. Example <ul style="list-style-type: none"> ■ 0 = Year 2000 ■ 99 = Year 2099
1699	Transfer date to clock	0	Yes	Adjusted date will be transferred to the unit.
			No	Adjusted date will be not transferred to the unit.
				Notes This parameter may only be configured using ToolKit.
4591	Daylight saving time	2		The daylight saving time feature enables to automatically adjust the real-time clock to local daylight saving time (DST) provisions. If daylight saving time is enabled, the real-time clock will automatically be advanced by one hour when the configured DST begin date and time is reached and falls back again by one hour when the configured DST end date and time is reached. If the unit is used in the southern hemisphere, the DST function will be inverted automatically, if the DST begin month is later in the year than the DST end month.
			On	Daylight saving time is enabled.
			[Off]	Daylight saving time is disabled.
				Notes Do not change the time manually during the hour of the automatic time change if DST is enabled to avoid a wrong time setting. Events or alarms, which occur during this hour might have a wrong time stamp.
4594	DST begin time	2	0 to 23 [2]	The real-time clock will be advanced by one hour when this time is reached on the DST begin date. Example <ul style="list-style-type: none"> ■ 0 = 0th hour of the day (midnight) ■ 23 = 23rd hour of the day (11 pm)
				Notes This parameter is only displayed, if Daylight saving time (parameter 4591 ↗ p. 68) is set to "On".

ID	Parameter	CL	Setting range [Default]	Description
4598	DST begin weekday	2	Sunday to Saturday [Sunday]	The weekday for the DST begin date is configured here Notes This parameter is only displayed, if Daylight saving time (parameter 4591 ↪ p. 68) is set to "On".
4592	DST begin nth. weekday	2		The order number of the weekday for the DST begin date is configured here.
			1st	DST starts on the 1st configured weekday of the DST begin month.
			2nd	DST starts on the 2nd configured weekday of the DST begin month.
			3rd	DST starts on the 3rd configured weekday of the DST begin month.
			4th	DST starts on the 4th configured weekday of the DST begin month.
			[Last]	DST starts on the last configured weekday of the DST begin month.
			LastButOne	DST starts on the last but one configured weekday of the DST begin month.
			LastButTwo	DST starts on the last but two configured weekday of the DST begin month.
			LastButThree	DST starts on the last but three configured weekday of the DST begin month.
	Notes This parameter is only displayed, if Daylight saving time (parameter 4591 ↪ p. 68) is set to "On".			
4593	DST begin month	2	1 to 12 [3]	The month for the DST begin date is configured here. Example <ul style="list-style-type: none"> ■ 1 = 1st month of the year ■ 12 = 12th month of the year Notes This parameter is only displayed, if Daylight saving time (parameter 4591 ↪ p. 68) is set to "On".
4597	DST end time	2	0 to 23 [3]	The real-time clock will fall back by one hour when this time is reached on the DST end date Example <ul style="list-style-type: none"> ■ 0 = 0th hour of the day (midnight). ■ 23 = 23rd hour of the day (11 pm). Notes This parameter is only displayed, if Daylight saving time (parameter 4591 ↪ p. 68) is set to "On".
4599	DST end weekday	2	Sunday to Saturday [Sunday]	The weekday for the DST end date is configured here Notes This parameter is only displayed, if Daylight saving time (parameter 4591 ↪ p. 68) is set to "On".
4595	DST end nth. weekday	2		The order number of the weekday for the DST begin date is configured here.
			1st	DST ends on the 1st configured weekday of the DST begin month.
			2nd	DST ends on the 2nd configured weekday of the DST begin month.
			3rd	DST ends on the 3rd configured weekday of the DST begin month.
			4th	DST ends on the 4th configured weekday of the DST begin month.
			[Last]	DST ends on the last configured weekday of the DST begin month.
			LastButOne	DST ends on the last but one configured weekday of the DST begin month.
			LastButTwo	DST ends on the last but two configured weekday of the DST begin month.
			LastButThree	DST ends on the last but three configured weekday of the DST begin month.

Configuration

Basic Setup > Configure Language/Clock

ID	Parameter	CL	Setting range [Default]	Description
				Notes This parameter is only displayed, if Daylight saving time (parameter 4591 ↗ p. 68) is set to "On".
4596	DST end month	2	1 to 12 [10]	The month for the DST begin date is configured here. Example <ul style="list-style-type: none"> ■ 1 = 1st month of the year ■ 12 = 12th month of the year Notes This parameter is only displayed, if Daylight saving time (parameter 4591 ↗ p. 68) is set to "On".

Example

If daylight saving time starts at 2:00 am on the 2nd Sunday in March and ends at 2:00 am on the 1st Sunday in November, the unit has to be configured like shown in ↗ *Table 21 "Daylight saving time - configuration example" on page 70* to enable an automatic change to daylight saving time and back to standard time.

ID	Parameter	Setting
4591	Daylight saving time	On
4594	DST begin time	2
4598	DST begin weekday	Sunday
4592	DST begin nth weekday	2nd
4593	DST begin month	3
4597	DST end time	2
4599	DST end weekday	Sunday
4595	DST end Sunday	1st
4596	DST end month	11

Table 21: Daylight saving time - configuration example

	USA, Canada		European Union	
Year	DST Begins 2 a.m. (Second Sunday in March)	DST Ends 2 a.m. (First Sunday in November)	DST Begins 1 a.m. UTC=GMT (Last Sunday in March)	DST Ends 1 a.m. UTC=GMT (Last Sunday in October)
2015	March 8, 2015	November 1, 2015	March 29, 2015	October 25, 2015
2016	March 13, 2016	November 6, 2016	March 27, 2016	October 30, 2016
2017	March 12, 2017	November 5, 2017	March 26, 2017	October 29, 2017

Table 22: Daylight saving time - exemplary dates

4.1.2 Configure Display

The contrast of the display may be adjusted using this screen.



Fig. 57: LS-52x v2 Configure display

4.1.3 Enter Password

General notes

The controller utilizes a password protected multi-level configuration access hierarchy. This permits varying degrees of access to the parameters being granted by assigning unique passwords to designated personnel.

A distinction is made between the access levels as follows:

Code level	
Code level CL0 (User Level) Standard password = none	This code level permits for monitoring of the system and limited access to the parameters. Configuration of the control is not permitted. Only the parameters for setting the language, the date, the time, and the horn reset time are accessible. The unit powers up in this code level.
Code level CL1 (Service Level) Standard password = "0 0 0 1"	This code level entitles the user to change selected non-critical parameters, such as setting the parameters accessible in CL0 plus Bar/PSI, °C/°F. The user may also change the password for level CL1. Access granted by this password expires two hours after the password has been entered and the user is returned to the CL0 level.
Code level CL2 (Temporary Commissioning Level) No standard password available	This code level grants temporary access to most of the parameters. The password is calculated from the random number generated when the password is initially accessed. It is designed to grant a user one-time access to a parameter without having to give him a reusable password. The user may also change the password for level CL1. Access granted by this password expires two hours after the password has been entered and the user is returned to the CL0 level. The password for the temporary commissioning level may be obtained from the vendor.
Code level CL3 (Commissioning Level) Standard password = "0 0 0 3"	This code level grants complete and total access to most of the parameters. In addition, the user may also change the passwords for levels CL1, CL2 and CL3. Access granted by this password expires two hours after the password has been entered and the user is returned to the CL0 level.



Once the code level is entered, access to the configuration menus will be permitted for two hours or until another password is entered into the control. If a user needs to exit a code level then code level, CL0 should be entered. This will block unauthorized configuration of the control.

A user may return to CL0 by allowing the entered password to expire after two hours or by changing any one digit on the random number generated on the password screen and entering it into the unit.

It is possible to disable expiration of the password by entering "0000" after the CL1 or CL3 password has been entered. Access to the entered code level will remain enabled until another password is entered. Otherwise, the code level would expire when loading the standard values (default 0000) via ToolKit.

Code level display

The current code level is indicated by the corresponding numeric value (e.g. "Code level display": "1") in the configuration menu screens. The value indicates that all parameters of a higher code level are "locked".

ID	Parameter	CL	Setting range [Default]	Description
10400	Password display	0	0000 to 9999 [random number]	The password for configuring the control via the front panel must be entered here.
10405	Code level display	0	(display only) [0]	This value displays the code level, which is currently enabled for access via the front panel display.
10402	Password for CAN interface 1	0	0000 to 9999 [random number]	The password for configuring the control via the CAN interface #1 must be entered here.
10407	Code level CAN interface 1	0	(display only) [0]	This value displays the code level, which is currently enabled for access via the CAN interface #1.
10401	Password for serial interface 1	0	0000 to 9999 [random number]	The password for configuring the control via RS-232 serial interface #1 must be entered here.
10406	Code level serial interface 1	0	(display only) [0]	This value displays the code level, which is currently enabled for access via RS-232 serial interface #1.
10430	Password for serial interface 2	2	0000 to 9999 [random number]	The password for configuring the control via RS-485 serial interface #1 must be entered here..
10420	Code level serial interface 2	0	(display only) [0]	This value displays the code level, which is currently enabled for access via RS-485 serial interface #1.

4.1.4 System Management

ID	Parameter	CL	Setting range [Default]	Description
1702	Device number	2	33 to 64 [33]	<p>A unique address is assigned to the control through this parameter. This unique address permits the controller to be correctly identified on the CAN bus. The address assigned to the controller may only be used once.</p> <p>All other bus addresses are calculated on the number entered in this parameter.</p> <p>Notes</p> <p>The unit must be restarted after changing the device number to ensure proper operation.</p> <p>No access in the application modes 403 and 404.</p>
4556	Configure display backlight	2	On	The display backlight is always enabled.
			Off	The display backlight is always disabled.
			[Key activate]	The display backlight will be dimmed, if no soft key is pressed for the time configured in parameter 4557 ↗ p. 73.
4557	Time until backlight shut-down	2	1 to 999 min [120 min]	<p>If no soft key has been pressed for the time configured here, the display backlight will be dimmed.</p> <p>Notes</p> <p>This parameter is only effective, if parameter 4556 ↗ p. 73 is configured to "Key activate".</p>
12978	Lock keypad	2	Determined by LogicsManager	<p>The result of the LogicsManager evaluation determines the following:</p> <p>True:</p> <ul style="list-style-type: none"> ■ The buttons "MAN" and "AUTO" are locked. ■ The softkeys "OPEN"/"CLOSE" are locked. ■ Acknowledge of alarms is blocked. ■ All parameters with the exception of display relevant parameters are not accessible. <p>False</p> <ul style="list-style-type: none"> ■ Full access is granted depending on the code level. <p>Notes</p> <p>Please be aware that this function is able to block the device front panel access.</p> <p>Typically this function is triggered by an external key switch connected to a discrete input. This discrete input should be configured to "Control" (DI {x} Alarm class) or "Self acknowledge" (DI {x} Self acknowledge).</p> <p>In case of misconfiguration an external access is only possible via external interface or ToolKit configuration software.</p> <p>In case of misconfiguration the access is only possible via an external interface or ToolKit configuration software.</p>
			Yes	The following three parameters are visible and restoring the configured parameters to factory default values is enabled.
			[No]	The following three parameters are invisible and restoring the configured parameters to factory default values is not enabled.
1701	Set factory default values	0	Yes	All parameters, which the enabled access code grants privileges to, will be restored to factory default values.
			[No]	All parameters will remain as currently configured.
			Notes	This parameter is only displayed, if Factory Settings (parameter 10417 ↗ p. 73) is set to "Yes".
10500	Start Boot-loader	2	00000 [42405]	The bootloader is utilized for uploading application software only. The proper enable code must be entered while the control is in access code level CL3 or higher to perform this function.

ID	Parameter	CL	Setting range [Default]	Description
				Notes This parameter is only displayed, if Factory Settings (parameter 10417 ↗ p. 73) is set to "Yes". This function is used for uploading application software and may only be used by authorized Woodward service personnel!
1706	Clear eventlog	2	Yes	The event history will be cleared.
			[No]	The event history will not be cleared.
				Notes This parameter is only displayed, if Factory Settings (parameter 10417 ↗ p. 73) is set to "Yes".

4.1.5 Password System

General notes



The following passwords grant varying levels of access to the parameters.

Each individual password can be used to access the appropriate configuration level through multiple access methods and communication protocols (via the front panel, via serial RS-232/485 interface, and via the CAN bus).

ID	Parameter	CL	Setting range [Default]	Description
10415	Basic code level	1	1 to 9999 [-]	The password for the code level "Service" is defined in this parameter. Refer to ↗ Chapter 4.1.3 "Enter Password" on page 71 for default values.
10413	Commissioning code level	3	1 to 9999 [-]	The password for the code level "Commission" is defined in this parameter. Refer to ↗ Chapter 4.1.3 "Enter Password" on page 71 for default values.
10414	Temp. commissioning code level	3	1 to 9999 [-]	The algorithm for calculating the password for the code level "Temporary Commissioning" is defined in this parameter.
10412	Temp. supercomm. level code	5	1 to 9999 [-]	The algorithm for calculating the password for the code level "Temporary Supercommissioning" is defined in this parameter.
10411	Supercommissioning level code	5	1 to 9999 [-]	The password for the code level "Supercommissioning" is defined in this parameter. Refer to ↗ Chapter 4.1.3 "Enter Password" on page 71 for default values.

4.1.6 Configure Status/Monitoring (home) screen

Configure HMI



Configurable via ToolKit only!

System A and system B text can be configured. It will be used with Status/Monitoring screen for HMI and home screen of ToolKit. The parameters of system A and system B will still come with "SysA / SyA." or "SysB / SyB." notification - the customizable text described below is just a heading.

ID	Parameter	CL	Setting range [Default]	Description
1891	Description system A	2	1 to 5 characters [SysA]	<p>Name is displayed on ...</p> <ul style="list-style-type: none"> page 1 of HMI home screen Status/monitoring: to the left of the values of system A page 2 of HMI home screen Status/monitoring: above values of system A ToolKit home screen: as single line description at system A side <p>Notes</p> <p>The max. possible number of characters is eight but only five will be displayed correctly on HMI/display.</p>
1892	Description system B	2	1 to 5 characters [SysB]	<p>Name displayed on ...</p> <ul style="list-style-type: none"> page 1 of HMI home screen Status/monitoring: to the left of the values of system B page 2 of HMI home screen Status/monitoring: above values of system B ToolKit home screen: as single line description at system B side <p>Notes</p> <p>The max. possible number of characters is eight but only five will be displayed correctly on HMI/display.</p>

Table 23: Parameters Customer Screen Configuration

4.2 Configure Measurement

ID	Parameter	CL	Setting range [Default]	Description
1750	System rated frequency	2	50 / 60 Hz [50 Hz]	The rated frequency of the system is used as a reference figure for all frequency related functions, which use a percentage value, like frequency monitoring, breaker operation windows or the Analog Manager.
1766	SyA. rated voltage	2	50 to 650000 V [400 V]	<p>The system A potential transformer primary voltage is entered in this parameter.</p> <p>The system A rated voltage is used as a reference figure for all system A voltage related functions, which use a percentage value, like system A voltage monitoring, breaker operation windows or the Analog Manager.</p>
1752	SyA. rated active power [kW]	2	0.5 to 99999.9 kW [200.0 kW]	This value specifies the system A real power rating, which is used as a reference figure for related functions.
1758	SyA. rated react. power [kvar]	2	0.5 to 99999.9 kvar [200.0 kvar]	This value specifies the system A reactive power rating, which is used as a reference figure for related functions.
1754	SyA. rated current	2	1 to 32000 A [300 A]	This value specifies the system A rated current, which is used as a reference figure for related functions.

Configuration

Configure Measurement

ID	Parameter	CL	Setting range [Default]	Description
1768	SyB. rated voltage	2	50 to 650000 V [400 V]	<p>The system B potential transformer primary voltage is entered in this parameter.</p> <p>The system B rated voltage is used as a reference figure for all system B voltage related functions, which use a percentage value, like system BS voltage monitoring, breaker operation windows or the Analog Manager.</p>
1858	1Ph2W voltage measuring	2	[Phase - phase]	The unit is configured for measuring phase-phase voltages if 1Ph 2W measuring is selected.
			Phase - neutral	The unit is configured for measuring phase-neutral voltages if 1Ph 2W measuring is selected.
			Notes	For information on measuring principles refer to Chapter 3.3.4.2 "System A Voltage" on page 43 .
1859	1Ph2W phase rotation	2	[CW]	A clockwise rotation field is considered for 1Ph 2W measuring .
			CCW	A counter-clockwise rotation field is considered for 1Ph 2W measuring.
			Notes	<p>The measurement of phase rotation with 1Ph2W is not possible. For this reason monitoring phase rotation mismatch is working with this supposed phase rotation.</p> <p>For information on measuring principles refer to Chapter 3.3.4.2 "System A Voltage" on page 43.</p>
1851	SyA. voltage measuring	2	3Ph 4W OD	<p>Measurement is performed Line-Neutral (Open Delta connected system). The voltage is connected via transformer with 3 Wire.</p> <p>Phase voltages and the neutral must be connected for proper calculation.</p> <p>Measurement, display and protection are adjusted according to the rules for Open Delta connected systems.</p> <p>Monitoring refers to the following voltages:</p> <ul style="list-style-type: none"> ■ VL12, VL23 and VL31
			[3Ph 4W]	<p>Measurement is performed Line-Neutral (WYE connected system) and Line-Line (Delta connected system). The protection depends on the setting of parameter 1771 p. 79.</p> <p>Phase voltages and the neutral must be connected for proper calculation. Measurement, display and protection are adjusted according to the rules for WYE connected systems.</p> <p>Monitoring refers to the following voltages:</p> <ul style="list-style-type: none"> ■ VL12, VL23 and VL31 (parameter 1771 p. 79 configured to "Phase-phase") ■ VL1N, VL2N and VL3N (parameter 1771 p. 79 configured to "Phase-neutral") ■ VL12, VL23, VL31, VL1N, VL2N and VL3N (parameter 1771 p. 79 configured to "All")
			3Ph 3W	<p>Measurement is performed Line-Line (Delta connected system). Phase voltages must be connected for proper calculation.</p> <p>Measurement, display and protection are adjusted according to the rules for Delta connected systems.</p> <p>Monitoring refers to the following voltages:</p> <ul style="list-style-type: none"> ■ VL12, VL23, VL31
			1Ph 2W	<p>Measurement is performed Line-Neutral (WYE connected system) if parameter 1858 p. 76 is configured to "Phase - neutral" and Line-Line (Delta connected system) if parameter 1858 p. 76 is configured to "Phase - phase".</p> <p>Measurement, display and protection are adjusted according to the rules for phase-phase systems.</p> <p>Monitoring refers to the following voltages:</p> <ul style="list-style-type: none"> ■ VL1N, VL12

ID	Parameter	CL	Setting range [Default]	Description
			1Ph 3W	<p>Measurement is performed Line-Neutral (WYE connected system) and Line-Line (Delta connected system). The protection depends on the setting of parameter 1771 ↗ p. 79.</p> <p>Measurement, display, and protection are adjusted according to the rules for single-phase systems.</p> <p>Monitoring refers to the following voltages:</p> <ul style="list-style-type: none"> VL13 (parameter 1771 ↗ p. 79 configured to "Phase-phase") VL1N, VL3N (parameter 1771 ↗ p. 79 configured to "Phase-neutral") VL1N, VL3N (parameter 1771 ↗ p. 79 configured to "All")
				<p>Notes</p> <p>If this parameter is configured to 1Ph 3W, the system A rated voltages (parameters 1766 ↗ p. 75 must be entered as Line-Line (Delta).</p> <p>For information on measuring principles refer to ↗ Chapter 3.3.4.2 "System A Voltage" on page 43.</p>
1850	SyA. current measuring	2	[L1 L2 L3]	<p>All three phases are monitored. Measurement, display and protection are adjusted according to the rules for 3-phase measurement. Monitoring refers to the following currents: IL1, IL2, IL3</p>
			Phase L{1/2/3}	<p>Only one phase is monitored. Measurement, display and protection are adjusted according to the rules for single-phase measurement.</p> <p>Monitoring refers to the selected phase.</p>
				<p>Notes</p> <p>This parameter is only effective if system A voltage measuring (parameter 1851 ↗ p. 76) is configured to "3Ph 4W" or "3Ph 3W".</p> <p>For information on measuring principles refer to ↗ Chapter 3.3.4.2 "System A Voltage" on page 43.</p>
1853	SyB. voltage measuring	2	[3Ph 4W]	<p>Measurement is performed Line-Neutral (WYE connected system) and Line-Line (Delta connected system). The protection depends on the setting of parameter 1770 ↗ p. 104.</p> <p>Phase voltages and the neutral must be connected for proper calculation. Measurement, display and protection are adjusted according to the rules for WYE connected systems.</p> <p>Monitoring refers to the following voltages:</p> <ul style="list-style-type: none"> VL12, VL23 and VL31 (parameter 1770 ↗ p. 104 configured to "Phase-phase") VL1N, VL2N and VL3N (parameter 1770 ↗ p. 104 configured to "Phase-neutral")
			3Ph 3W	<p>Measurement is performed Line-Line (Delta connected system). Phase voltages must be connected for proper calculation.</p> <p>Measurement, display and protection are adjusted according to the rules for Delta connected systems.</p> <p>Monitoring refers to the following voltages:</p> <ul style="list-style-type: none"> VL12, VL23, VL31
			1Ph 2W	<p>Measurement is performed Line-Neutral (WYE connected system) if parameter 1858 ↗ p. 76 is configured to "Phase - neutral" and Line-Line (Delta connected system) if parameter 1858 ↗ p. 76 is configured to "Phase - phase".</p> <p>Measurement, display and protection are adjusted according to the rules for phase-phase systems.</p> <p>Monitoring refers to the following voltages:</p> <ul style="list-style-type: none"> VL1N, VL12

ID	Parameter	CL	Setting range [Default]	Description
			1Ph 3W	<p>Measurement is performed Line-Neutral (WYE connected system) and Line-Line (Delta connected system).</p> <p>The protection depends on the setting of parameter 1770 ↗ p. 104. Measurement, display, and protection are adjusted according to the rules for single-phase systems.</p> <p>Monitoring refers to the following voltages:</p> <ul style="list-style-type: none"> ■ VL13 (parameter 1770 ↗ p. 104 configured to "Phase-phase") ■ VL1N, VL3N (parameter 1770 ↗ p. 104 configured to "Phase-neutral")
				<p>Notes</p> <p>If this parameter is configured to 1Ph 3W, the system B rated voltages (parameter 1768 ↗ p. 76) must be entered as Line-Line (Delta).</p> <p>For information on measuring principles refer to ↗ Chapter 3.3.4.2 "System A Voltage" on page 43.</p>

4.2.1 Configure Transformer

General notes

This controller is available in two different hardware versions with either 1A [..1] or 5A [..5] current transformer inputs. The setpoints for specific current parameters will differ depending upon the hardware version, indicated on the data plate.

- [1] LS-5xx-1 = Current transformer with ..1 A rated current
- [5] LS-5xx-5 = Current transformer with ..5 A rated current

This controller offers separate terminals for two different input voltages with either 120 Vac or 480 Vac. The setpoint/ranges for specific voltage parameters will differ depending upon the voltage selected by the terminals connected.

- Terminals 14, 16, 18, 20; 22, 24, 26, 28 = 120 Vac
- Terminals 15, 17, 19, 21; 23, 25, 27, 29 = 480 Vac

ID	Parameter	CL	Setting range [Default]	Description
1801	SyA. PT primary rated voltage	2	50 to 650000 V [400 V]	<p>Some applications may require the use of potential transformers to facilitate measuring the voltages. The rating of the primary side of the potential transformer must be entered into this parameter.</p> <p>If the application does not require potential transformers at system A (i.e. the voltage is 480 V or less), then this voltage will be entered into this parameter.</p>
1800	SyA. PT secondary rated voltage	2	50 to 480 V [400 V]	<p>Some applications may require the use of potential transformers to facilitate measuring the voltages. The rating of the secondary side of the potential transformer must be entered into this parameter.</p> <p>If the application does not require potential transformers at system A (i.e. the voltage is 480 V or less), then this voltage will be entered into this parameter.</p> <ul style="list-style-type: none"> ■ Rated voltage: 120 Vac (this parameter configured between 50 and 130 V) System A voltage: Terminals 14/16/18/20 ■ Rated voltage: 480 Vac (this parameter configured between 131 and 480 V) System A voltage: Terminals 15/17/19/21

ID	Parameter	CL	Setting range [Default]	Description
				<p>Notes</p> <p>WARNING: Only connect the measured voltage to either the 120 Vac or the 480 Vac inputs. Do not connect both sets of inputs to the measured system.</p> <p>The control unit is equipped with dual voltage measuring inputs. The voltage range of these measurement inputs is dependent upon input terminals are used. This value refers to the secondary voltages of the potential transformers, which are directly connected to the control unit.</p>
1806	SyA. CT primary rated current	2	1 to 32000 A/x [500 A/x]	<p>The input of the current transformer ratio is necessary for the indication and control of the actual monitored value.</p> <p>The current transformers ratio should be selected so that at least 60 % of the secondary current rating can be measured when the monitored system is at 100 % of operating capacity (i.e. at 100 % of system capacity a 5 A CT should output 3 A).</p> <p>If the current transformers are sized so that the percentage of the output is lower, the loss of resolution may cause inaccuracies in the monitoring and control functions and affect the functionality of the control.</p> <p>Notes</p> <p>"..x" is the current (1 A / 5 A) defined by hardware version.</p>
1804	SyB. PT primary rated voltage	2	50 to 650000 V [400 V]	<p>Some applications may require the use of potential transformers to facilitate measuring the voltages to be monitored. The rating of the primary side of the potential transformer must be entered into this parameter.</p> <p>Notes</p> <p>If the application does not require potential transformers (i.e. the measured voltage is 480 V or less), then the measured voltage will be entered into this parameter.</p>
1803	SyB. PT secondary rated voltage	2	50 to 480 V [400 V]	<p>Some applications may require the use of potential transformers to facilitate measuring the mains voltages. The rating of the secondary side of the potential transformer must be entered into this parameter.</p> <p>If the application does not require potential transformers (i.e. the measured voltage is 480 V or less), then the measured voltage will be entered into this parameter.</p> <ul style="list-style-type: none"> ■ Rated voltage: 120 Vac (this parameter configured between 50 and 130 V) System B voltage: Terminals 22/24/26/28 ■ Rated voltage: 480 Vac (this parameter configured between 131 and 480 V) System B Voltage: Terminals 23/25/27/29 <p>Notes</p> <p>WARNING: Only connect the measured voltage to either the 120 Vac or the 480 Vac inputs. Do not connect both sets of inputs to the measured system.</p> <p>The control is equipped with dual voltage measuring inputs. The voltage range of these measurement inputs is dependent upon input terminals are used. This value refers to the secondary voltages of the potential transformers, which are directly connected to the control.</p>

4.3 Configure Monitoring

4.3.1 System A

ID	Parameter	CL	Setting range [Default]	Description
1771	SyA. voltage monitoring	2		<p>The unit can either monitor the wye voltages (phase-neutral) or the delta voltages (phase-phase). The monitoring of the wye voltage is above all necessary to avoid earth-faults in a compensated or isolated network resulting in the tripping of the voltage protection.</p>
			[Phase - phase]	<p>The phase-phase voltage will be monitored and all subsequent parameters concerning voltage monitoring "system A" are referred to this value (VL-L).</p>

ID	Parameter	CL	Setting range [Default]	Description
			Phase - neutral	The phase-neutral voltage will be monitored and all subsequent parameters concerning voltage monitoring "system A" are referred to this value (VL-N).
			All	The phase-phase and phase-neutral voltage will be monitored and all subsequent parameters concerning voltage monitoring "system A" are referred to this value (VL-L & VL-N). This setting is only effective if "SyA. voltage measuring" (parameter 1851 ↗ p. 76) is configured to "3Ph 4W".
				Notes WARNING: This parameter influences the protective functions. Please be aware that if "SyA. voltage monitoring" (parameter 1771 ↗ p. 79) is configured to "All" and the function ↗ Chapter 4.3.1.10 "System A Voltage Increase" on page 91 is used, that this function only monitors "Phase - neutral".
2801	Mains settling time	2	0 to 9999 s [20 s]	To end the emergency operation, the monitored mains must be within the configured operating parameters without interruption for the minimum period of time set with this parameter without interruption. This parameter permits delaying the switching of the load from the generator to the mains. The display indicates "Mains settling" during this time.

4.3.1.1 System A Operating Voltage / Frequency

General notes



If system A is configured and wired for mains, the system A operating voltage/frequency parameters can be used to trigger mains failure conditions and activate an emergency run.

The system A values must be within these ranges to synchronize the CBA.

- *It is recommended to configure the operating limits within the monitoring limits.*

Example

If the system A rated voltage is 400 V, the upper voltage limit is 110 % (of the system A rated voltage, i.e. 440 V), and the hysteresis for the upper voltage limit is 5 % (of the mains rated voltage, i.e. 20 V), the system A voltage will be considered as being out of the operating limits as soon as it exceeds 440 V and will be considered as being within the operating limits again as soon as it falls below 420 V (440 V – 20 V).

If the rated system frequency is 50 Hz, the lower frequency limit is 90 % (of the rated system frequency, i.e. 45 Hz), and the hysteresis for the lower frequency limit is 5 % (of the rated system frequency, i.e. 2.5 Hz), the mains frequency will be considered as being out of the operating limits as soon as it falls below 45 Hz and will be considered as being within the operating limits again as soon as it exceeds 47.5 Hz (45 Hz + 2.5 Hz).

ID	Parameter	CL	Setting range [Default]	Description
5810	Upper voltage limit	2	100 to 150 % [110 %]	The maximum permissible positive deviation of the system A voltage from the system A rated voltage (parameter 1768 ↗ p. 76) is configured here. This value may be used as a voltage limit switch. The conditional state of this switch may be used as a command variable for the LogicsManager (02.09).
5814	Hysteresis upper voltage limit	2	0 to 50 % [2 %]	If the system A voltage has exceeded the limit configured in parameter 5810 ↗ p. 81, the voltage must fall below the limit and the value configured here, to be considered as being within the operating limits again.
5811	Lower voltage limit	2	50 to 100 % [90 %]	The maximum permissible negative deviation of the system A voltage from the system A rated voltage (parameter 1768 ↗ p. 76) is configured here. This value may be used as a voltage limit switch. The conditional state of this switch may be used as a command variable for the LogicsManager (02.09).
5815	Hysteresis lower voltage limit	2	0 to 50 % [2 %]	If the system A voltage has fallen below the limit configured in parameter 5811 ↗ p. 81, the voltage must exceed the limit and the value configured here, to be considered as being within the operating limits again.
5812	Upper frequency limit	2	100.0 to 150.0 % [105.0 %]	The maximum permissible positive deviation of the system A frequency from the rated system frequency (parameter 1750 ↗ p. 75) is configured here. This value may be used as a frequency limit switch. The conditional state of this switch may be used as a command variable for the LogicsManager (02.10).
5816	Hysteresis upper frequency limit	2	0 to 50 % [0.5 %]	If the system A frequency has exceeded the limit configured in parameter 5812 ↗ p. 81, the frequency must fall below the limit and the value configured here, to be considered as being within the operating limits again.
5813	Lower frequency limit	2	50.0 to 100.0 % [95.0 %]	The maximum permissible negative deviation of the system A frequency from the rated system frequency (parameter 1750 ↗ p. 75) is configured here. This value may be used as a frequency limit switch. The conditional state of this switch may be used as a command variable for the LogicsManager (02.10).
5817	Hysteresis lower frequency limit	2	0 to 50 % [0.5 %]	If the system A frequency has fallen below the limit configured in parameter 5813 ↗ p. 81, the frequency must exceed the limit and the value configured here, to be considered as being within the operating limits again.

4.3.1.2 System A Decoupling

General notes

The system A decoupling function is intended for use in a mains parallel operation and monitors a series of subordinate mains protection thresholds. If a threshold is exceeded, the LS-5 initiates a breaker opening and separates the system B from the mains at the defined breaker.

The mains decoupling can be fully maintained by the LS-5 device as long no mains decoupling according to VDE-AR-N 4105 is required. If mains decoupling according to VDE-AR-N 4105 is required, please refer to ↗ *Chapter 4.3.1.11 "Setup System A for VDE-AR-N 4105" on page 93.*

The following thresholds are monitored:

- Overfrequency level 1 (↗ *Chapter 4.3.1.5 "System A Overfrequency (Levels 1 & 2) ANSI# 81O" on page 85*)
- Overfrequency level 2 (↗ *Chapter 4.3.1.5 "System A Overfrequency (Levels 1 & 2) ANSI# 81O" on page 85*)
- Underfrequency level 1 (↗ *Chapter 4.3.1.6 "System A Underfrequency (Level 1 & 2) ANSI# 81U" on page 86*)
- Underfrequency level 2 ↗ *Chapter 4.3.1.6 "System A Underfrequency (Level 1 & 2) ANSI# 81U" on page 86*)
- Overvoltage level 1 if parametrized for decoupling (↗ *Chapter 4.3.1.7 "System A Overvoltage (Level 1 & 2) ANSI# 59" on page 87*)

- Overvoltage level 2 ([↪ Chapter 4.3.1.7 “System A Overvoltage \(Level 1 & 2\) ANSI# 59” on page 87](#))
- Undervoltage level 1 if parametrized ([↪ Chapter 4.3.1.8 “System A Undervoltage \(Level 1 & 2\) ANSI# 27” on page 88](#))
- Undervoltage level 2 ([↪ Chapter 4.3.1.8 “System A Undervoltage \(Level 1 & 2\) ANSI# 27” on page 88](#))
- Phase shift or df/dt ([↪ Chapter 4.3.1.3 “Phase Shift” on page 82](#))
- Voltage increase if parametrized for decoupling ([↪ Chapter 4.3.1.10 “System A Voltage Increase” on page 91](#))

If one of these protective functions is triggered, the display indicates "SyA. decoupling" (the logical command variable "07.25" will be enabled) and an active level 2 alarm.



The decoupling function is optimized on the relay outputs "CBA open". In case of using a free relay output in conjunction with the command variable 07.25 an additional delay time of up to 20 ms must be considered.

ID	Parameter	CL	Setting range [Default]	Description
12942	Enable SyA. decoupling	2	Determined by LogicsManager	If LogicsManager 24.31 is true, decoupling is "On". Notes For information on the LogicsManager and its default settings see ↪ Chapter 9.3.1 “LogicsManager Overview” on page 354.
3058	Change of frequency	2	Off	Change of frequency is not monitored.
			[Ph. shift]	Change of frequency is monitored on phase shift.
			df/dt	Change of frequency is monitored on df/dt (ROCOF).
			Ph-sh.,df/dt	Change of frequency is monitored on df/dt (ROCOF) and on phase shift (logical OR).
3110	SyA. decoupling	2	Off	System A decoupling is disabled
			[CBA]	System A decoupling is carried out according to the following parameters. If one of the subordinate monitoring functions is triggered, the CBA will be opened.
3111	Alarm class	2	A/B/C/D/E/F/Control [B]	Each limit may be assigned an independent alarm class that specifies what action should be taken when the limit is surpassed. For additional information refer to ↪ Chapter 9.4.1 “Alarm Classes” on page 384.
3112	Self acknowledge	2	Yes	The control unit automatically clears the alarm if the fault condition is no longer detected.
			[No]	The control unit does not automatically reset the alarm when the fault condition is no longer detected. The alarm must be acknowledged and reset by manually pressing the appropriate buttons or by activating the LogicsManager output "External acknowledgement" (via a discrete input or via an interface).

4.3.1.3 Phase Shift

General notes

A vector/phase shift is defined as the sudden variation of the voltage curve which may be caused by a major generator load change.

The unit measures the duration of a cycle, where a new measurement is started with each voltage passing through zero. The measured cycle duration will be compared with an internal quartz-calibrated reference time to determine the cycle duration difference of the voltage signal.

A vector/phase shift as shown in Fig. 58 causes a premature or delayed zero passage. The determined cycle duration difference corresponds with the occurring phase shift angle.

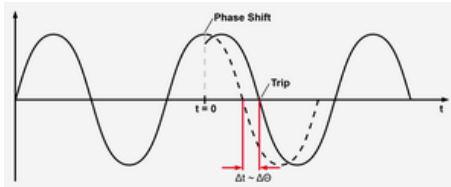

Fig. 58: Phase shift

The monitoring may be carried out three-phase or one/three-phase. The monitoring can be configured in different ways. The vector/phase shift monitor can also be used as an additional method to decouple from the grid. Vector/phase shift monitoring is only enabled after the monitored voltage exceeds 50% of the PT secondary rated voltage.



Function "Voltage cycle duration not within the permissible range"

The voltage cycle duration exceeds the configured limit value for the phase/vector shift. The result is, that the power circuit breaker that disconnects from the mains, is opened, the message "SyA. phase shift" is displayed, and the logical command variable "07.14" is enabled.



The "Phase shift" configuration parameters are located below the "SyA. decoupling" function menu on the display.

ID	Parameter	CL	Setting range [Default]	Description
3053	Monitoring	2	[1- and 3-phase]	During single-phase voltage phase/vector shift monitoring, tripping occurs if the phase/vector shift exceeds the configured threshold value (parameter 3054 ↗ p. 83) in at least one of the three phases.
			3-phase	During three-phase voltage phase/vector shift monitoring, tripping occurs only if the phase/vector shift exceeds the specified threshold value (parameter 3055 ↗ p. 83) in all three phases within 2 cycles.
			Notes	If a phase/vector shift occurs in one or two phases, the single-phase threshold value (parameter 3054 ↗ p. 83) is taken into consideration; if a phase/vector shift occurs in all three phases, the three-phase threshold value (parameter 3055 ↗ p. 83) is taken into consideration. Single phase monitoring is very sensitive and may lead to nuisance tripping if the selected phase angle settings are too small.
3054	Limit 1-phase	2	3 to 30° [20°]	If the electrical angle of the voltage shifts more than this configured value in any single phase, an alarm with the class configured in parameter 3051 ↗ p. 83 is initiated. The decoupling procedure will open the CBA.
3055	Limit 3-phase	2	3 to 30° [8°]	If the electrical angle of the voltage shifts more than this configured value in all three phases, an alarm with the class configured in parameter 3051 ↗ p. 83 is initiated. The decoupling procedure will open the CBA.
3051	Alarm class	2	A/B/C/D/E/F/ Control [B]	Each limit may be assigned an independent alarm class that specifies what action should be taken when the limit is surpassed.
			Notes	For additional information see ↗ Chapter 9.4.1 "Alarm Classes" on page 384.

ID	Parameter	CL	Setting range [Default]	Description
3052	Self acknowledge	2	[Yes]	The control unit automatically clears the alarm if the fault condition is no longer detected.
			No	The control unit does not automatically reset the alarm when the fault condition is no longer detected. The alarm must be acknowledged and reset by manually pressing the appropriate buttons or by activating the LogicsManager output "External acknowledgement" (via a discrete input or via an interface).
3056	Monitoring lockable	2	Yes	Monitoring for fault conditions is only performed if "Lock Monitoring Status 24.40" is false.
			[No]	Monitoring for this fault condition is continuously enabled regardless of "Lock Monitoring Status 24.40".

4.3.1.4 df/dt (ROCOF)

General notes

df/dt (rate of change of frequency) monitoring measures the stability of the frequency. The frequency of a source will vary due to changing loads and other effects. The rate of these frequency changes due to the load variances is relatively high compared to those of a large network.



Function "Rate of change of frequency not within permissible limits"

The control unit calculates the unit of measure per unit of time. The df/dt is measured over 4 sine waves to ensure that it is differentiated from a phase shift. This results in a minimum response time of approximately 100 ms (at 50 Hz).



The "df/dt (ROCOF)" configuration parameters are located below the "SyA. decoupling" function menu on the display.

ID	Parameter	CL	Setting range [Default]	Description
3104	Limit	2	0.1 to 9.9 Hz/s [2.6 Hz/s] (Hysteresis: 0.1 Hz/s) (Reset Delay: 80 ms)	The df/dt threshold is defined here. If this value is reached or exceeded for at least the delay time without interruption, an alarm with the class configured in parameter 3101 ↗ p. 84 is initiated. The decoupling procedure will open the CBA.
3105	Delay	2	0.10 to 2.00 s [0.10 s]	If the monitored rate of df/dt exceeds the threshold value for the delay time configured here, an alarm will be issued. If the monitored df/dt exceeds the threshold (plus the hysteresis) again before the delay expires the time will be reset.
3101	Alarm class	2	A/B/C/D/E/F/ Control [B]	Each limit may be assigned an independent alarm class that specifies what action should be taken when the limit is surpassed. Notes For additional information see ↗ Chapter 9.4.1 "Alarm Classes" on page 384.

ID	Parameter	CL	Setting range [Default]	Description
3102	Self acknowledge	2	Yes	The control unit automatically clears the alarm if the fault condition is no longer detected.
			[No]	The control unit does not automatically reset the alarm when the fault condition is no longer detected. The alarm must be acknowledged and reset by manually pressing the appropriate buttons or by activating the LogicsManager output "External acknowledgment" (via a discrete input or via an interface).
3103	Monitoring lockable	2	Yes	Monitoring for fault conditions is only performed if "Lock Monitoring Status 24.40" is false.
			[No]	Monitoring for this fault condition is continuously enabled regardless of "Lock Monitoring Status 24.40".

4.3.1.5 System A Overfrequency (Levels 1 & 2) ANSI# 810

General notes

There are two overfrequency alarm levels available in the control. Both alarms are definite time alarms and are illustrated in the figure below. The figure diagrams a frequency trend and the associated pickup times and length of the alarms. Monitoring of the frequency is accomplished in two steps.



If this protective function is triggered, the display indicates "SyA. overfrequency 1" or "SyA. overfrequency 2" and the logical command variable "07.06" or "07.07" will be enabled.

Refer to [Chapter 9.1.1 "Triggering Characteristics" on page 271](#) for the triggering characteristic of this monitoring function.



The system A overfrequency Level 2 limit configuration parameters are located below the "SyA. decoupling" function menu on the display.

ID	Parameter	CL	Setting range [Default]	Description
2850 2856	Monitoring (Limit 1/Limit 2)	2	[On]	Overfrequency monitoring is carried out according to the following parameters. Monitoring is performed at two levels. Both values may be configured independent from each other (prerequisite: Level 1 limit < limit 2).
			Off	Monitoring is disabled for Level 1 limit and/or Level 2 limit.
2854 2860	Limit (Limit 1/Limit 2)	2	100.0 to 130.0 % 2854: [100.4 %] 2860: [102.0 %]	The percentage values that are to be monitored for each threshold limit are defined here. If this value is reached or exceeded for at least the delay time without interruption, the action specified by the alarm class is initiated.
				Notes This value refers to the System rated frequency (parameter 1750 p. 75).
2855 2561	Delay (Limit 1/Limit 2)	2	0.02 to 99.99 s [0.06 s]	If the monitored system A frequency value exceeds the threshold value for the delay time configured here, an alarm will be issued.
				Notes If the monitored frequency falls below the threshold (minus the hysteresis) before the delay expires the time will be reset.

ID	Parameter	CL	Setting range [Default]	Description
2851 2857	Alarm class (Limit 1/Limit 2)	2	Class A/B/C/D/E/F/ Control 2851: [A] 2857: [B]	Each limit may be assigned an independent alarm class that specifies what action should be taken when the limit is surpassed. Notes For additional information refer to Chapter 9.4.1 "Alarm Classes" on page 384
2852 2858	Self acknowledge (Limit 1/Limit 2)	2	Yes [No]	The control unit automatically clears the alarm if the fault condition is no longer detected. The control unit does not automatically reset the alarm when the fault condition is no longer detected. The alarm must be acknowledged and reset by manually pressing the appropriate buttons or by activating the LogicsManager output "External acknowledgement" (via a discrete input or via an interface).
2853 2859	Monitoring lockable (Limit 1/Limit 2)	2	Yes [No]	Monitoring for fault conditions is only performed if "Lock Monitoring Status 24.40" is false. Monitoring for this fault condition is continuously enabled regardless of "Lock Monitoring Status 24.40".

4.3.1.6 System A Underfrequency (Level 1 & 2) ANSI# 81U

General notes

There are two underfrequency alarm levels available in the control. Both alarms are definite time alarms and are illustrated in the figure below. The figure diagrams a frequency trend and the associated pickup times and length of the alarms. Monitoring of the frequency is performed in two steps.



If this protective function is triggered, the display indicates "SyA. underfrequency 1" or "SyA. underfrequency 2" and the logical command variable "07.08" or "07.09" will be enabled.

Refer to [Chapter 9.1.1 "Triggering Characteristics"](#) on page 271 for the triggering characteristic of this monitoring function.



The system A underfrequency Level 2 limit configuration parameters are located below the "SyA. decoupling" function menu on the display.

ID	Parameter	CL	Setting range [Default]	Description
2900 2906	Monitoring (Limit 1/Limit 2)	2	[On] Off	Underfrequency monitoring is carried out according to the following parameters. Monitoring is performed at two levels. Both values may be configured independent from each other (prerequisite: Level 1 limit > limit 2). Monitoring is disabled for Level 1 limit and/or Level 2 limit.
2904 2910	Limit (Limit 1/Limit 2)	2	50.0 to 130.0 % 2904: [99.6 %] 2910: [98.0 %]	The percentage values that are to be monitored for each threshold limit are defined here. If this value is reached or exceeded for at least the delay time without interruption, the action specified by the alarm class is initiated.

ID	Parameter	CL	Setting range [Default]	Description
				Notes This value refers to the System rated frequency (parameter 1750 ↪ p. 75).
2905 2911	Delay (Limit 1/Limit 2)	2	0.02 to 99.99 s 2905: [1.50 s] 2911: [0.06 s]	If the monitored frequency value falls below the threshold value for the delay time configured here, an alarm will be issued. Notes If the monitored frequency falls below the threshold (plus the hysteresis) before the delay expires the time will be reset.
2901 2907	Alarm class (Limit 1/Limit 2)	2	Class A/B/C/D/E/F/ Control 2901: [A] 2907: [B]	Each limit may be assigned an independent alarm class that specifies what action should be taken when the limit is surpassed. Notes For additional information refer to ↪ Chapter 9.4.1 "Alarm Classes" on page 384
2902 2908	Self acknowl- edge (Limit 1/Limit 2)	2	Yes [No]	The control unit automatically clears the alarm if the fault condition is no longer detected. The control unit does not automatically reset the alarm when the fault condition is no longer detected. The alarm must be acknowledged and reset by manually pressing the appropriate buttons or by activating the LogicsManager output "External acknowledgement" (via a discrete input or via an interface).
2903 2909	Monitoring lockable	2	[Yes] No	Monitoring for fault conditions is only performed if "Lock Monitoring Status 24.40" is false. Monitoring for this fault condition is continuously enabled regardless of "Lock Monitoring Status 24.40".

4.3.1.7 System A Overvoltage (Level 1 & 2) ANSI# 59

General notes

Voltage is monitored depending on parameter "SyA. voltage measuring" (parameter 1851 ↪ p. 76). There are two overvoltage alarm levels available in the control. Both alarms are definite time alarms and are illustrated in the figure below. The figure diagrams a frequency trend and the associated pickup times and length of the alarms. Monitoring of the voltage is done in two steps.



If this protective function is triggered, the display indicates "SyA. overvoltage 1" or "System A overvoltage 2" and the logical command variable "07.10" or "07.11" will be enabled.

Refer to ↪ Chapter 9.1.1 "Triggering Characteristics" on page 271 for the triggering characteristic of this monitoring function.



The system A overvoltage Level 2 limit configuration parameters are located below the "SyA. decoupling" function menu on the display.

ID	Parameter	CL	Setting range [Default]	Description
2950 2956	Monitoring	2	[On]	Overvoltage monitoring is carried out according to the following parameters. Monitoring is performed at two levels. Both values may be configured independent from each other (prerequisite: Level 1 limit < limit 2).
Off			Monitoring is disabled for Level 1 limit and/or Level 2 limit.	
2954 2960	Limit	2	50.0 to 150.0 % 2954: [108.0 %] 2960: [110.0 %]	The percentage values that are to be monitored for each threshold limit are defined here. If this value is reached or exceeded for at least the delay time without interruption, the action specified by the alarm class is initiated.
Notes This value refers to the System rated frequency (parameter 1766 ↗ p. 75).				
2955 2961	Delay (Limit 1/Limit2)	2	0.02 to 99.99 s 2955: [1.50 s] 2961: [0.06 s]	If the monitored voltage value exceeds the threshold value for the delay time configured here, an alarm will be issued.
Notes If the monitored voltage falls below the threshold (minus the hysteresis) before the delay expires the time will be reset.				
2951 2957	Alarm class (Limit 1/Limit2)	2	Class A/B/C/D/E/F/ Control 2951: [A] 2957: [B]	Each limit may be assigned an independent alarm class that specifies what action should be taken when the limit is surpassed.
Notes For additional information refer to ↗ Chapter 9.4.1 "Alarm Classes" on page 384				
2953 2959	Self acknowledge (Limit 1/Limit2)	2	Yes	The control unit automatically clears the alarm if the fault condition is no longer detected.
			[No]	The control unit does not automatically reset the alarm when the fault condition is no longer detected. The alarm must be acknowledged and reset by manually pressing the appropriate buttons or by activating the LogicsManager output "External acknowledgement" (via a discrete input or via an interface).
2953 2959	Monitoring lockable (Limit 1/Limit2)	2	Yes	Monitoring for fault conditions is only performed if "Lock Monitoring Status 24.40" is false.
			[No]	Monitoring for this fault condition is continuously enabled regardless of "Lock Monitoring Status 24.40".
8845	SyA. decoupling	2		System A decoupling by overvoltage level 1
			On	Tripping of system A overvoltage level 1 causes decoupling.
			[Off]	Tripping of system A overvoltage level 1 does not cause decoupling.

4.3.1.8 System A Undervoltage (Level 1 & 2) ANSI# 27

General notes

Voltage is monitored depending on parameter "SyA. voltage measuring" (parameter 1851 ↗ p. 76). There are two undervoltage alarm levels available in the control. Both alarms are definite time alarms and are illustrated in the figure below. The figure diagrams a frequency trend and the associated pickup times and length of the alarms. Monitoring of the voltage is done in two steps.



If this protective function is triggered, the display indicates "SyA. undervoltage 1" or "SyA. undervoltage 2" and the logical command variable "07.12" or "07.13" will be enabled.

Refer to Chapter 9.1.1 "Triggering Characteristics" on page 271 for the triggering characteristic of this monitoring function.



The system A undervoltage Level 2 limit configuration parameters are located below the "SyA. decoupling" function menu on the display.

ID	Parameter	CL	Setting range [Default]	Description
3000 3006	Monitoring Limit 1/Limit 2	2	[On] Off	Undervoltage monitoring is carried out according to the following parameters. Monitoring is performed at two levels. Both values may be configured independent from each other (prerequisite: Level 1 limit < limit 2). Monitoring is disabled for Level 1 limit and/or Level 2 limit.
3004 3010	Limit Limit 1/Limit 2	2	10.0 to 150.0 % 3004: [92.0 %] 3010: [90.0 %]	The percentage values that are to be monitored for each threshold limit are defined here. If this value is reached or exceeded for at least the delay time without interruption, the action specified by the alarm class is initiated.
				Notes This value refers to the System rated frequency (parameter 1766 p. 75).
3005 3011	Delay	2	0.02 to 99.99 s 3005: [1.50 s] 3011: [0.06 s]	If the monitored voltage value falls below the threshold value for the delay time configured here, an alarm will be issued.
				Notes If the monitored voltage exceeds the threshold (plus the hysteresis) before the delay expires the time will be reset.
3001 3007	Alarm class Limit 1/Limit 2	2	Class A/B/C/D/E/F/ Control 3001: [A] 3007: [B]	Each limit may be assigned an independent alarm class that specifies what action should be taken when the limit is surpassed.
				Notes For additional information refer to Chapter 9.4.1 "Alarm Classes" on page 384
3002 3008	Self acknowledge Limit 1/Limit 2	2	Yes [No]	The control unit automatically clears the alarm if the fault condition is no longer detected. The control unit does not automatically reset the alarm when the fault condition is no longer detected. The alarm must be acknowledged and reset by manually pressing the appropriate buttons or by activating the LogicsManager output "External acknowledgement" (via a discrete input or via an interface).
3003 3009	Monitoring lockable Limit 1/Limit 2	2	[Yes] No	Monitoring for fault conditions is only performed if "Lock Monitoring Status 24.40" is false. Monitoring for this fault condition is continuously enabled regardless of "Lock Monitoring Status 24.40".
8844	SyA. decoupling	2		System A decoupling by undervoltage level 1

ID	Parameter	CL	Setting range [Default]	Description
			On	Tripping of system A undervoltage level 1 causes decoupling.
			[Off]	Tripping of system A undervoltage level 1 does not cause decoupling.

4.3.1.9 System A Voltage Asymmetry

General notes

Voltage asymmetry is determined by calculating the negative sequence component of a three-phase system. This value is derived from the three delta voltages (phase-phase). Voltage asymmetry monitoring is only active if "SyA. voltage measuring" (parameter 1851 ↗ p. 76) is configured to "3Ph 4W" or "3Ph 3W". The threshold is defined as the percentage of that value relative to the nominal delta voltage. The protective function is triggered if this percentage value is exceeded.



If this protective function is triggered, the display indicates "SyA. volt. asymmetry" and the logical command variable "06.18" will be enabled.

Refer to ↗ Chapter 9.1.1 "Triggering Characteristics" on page 271 for the triggering characteristic of this monitoring function.



This monitoring function is only enabled if system A voltage measuring (parameter 1851 ↗ p. 76) is configured to "3Ph 4W" or "3Ph 3W".

ID	Parameter	CL	Setting range [Default]	Description
3921	Monitoring	2	[On]	Voltage asymmetry monitoring is carried out according to the following parameters.
			Off	No monitoring is carried out.
3924	Limit	2	0.5 to 99.9 % [10.0 %]	The percentage values that are to be monitored for each threshold limit are defined here. If this value is reached or exceeded for at least the delay time without interruption, the action specified by the alarm class is initiated.
				Notes This value refers to the 'SyA rated voltage' (parameter 1766 ↗ p. 75).
3925	Delay	2	0.02 to 99.99 s [5.00 s]	If the monitored voltage asymmetry exceeds the threshold value for the delay time configured here, an alarm will be issued.
				Notes If the monitored voltage asymmetry falls below the threshold (minus the hysteresis) before the delay expires the time will be reset
3922	Alarm class	2	Class A/B/C/D/E/F/ Control [B]	Each limit may be assigned an independent alarm class that specifies what action should be taken when the limit is surpassed.
				Notes For additional information refer to ↗ Chapter 9.4.1 "Alarm Classes" on page 384

ID	Parameter	CL	Setting range [Default]	Description
3923	Self acknowledge	2	[Yes]	The control unit automatically clears the alarm if the fault condition is no longer detected.
			No	The control unit does not automatically reset the alarm when the fault condition is no longer detected. The alarm must be acknowledged and reset by manually pressing the appropriate buttons or by activating the LogicsManager output "External acknowledgement" (via a discrete input or via an interface).
3926	Monitoring lockable	2	Yes	Monitoring for fault conditions is only performed if "Lock Monitoring Status 24.40" is false.
			[No]	Monitoring for this fault condition is continuously enabled regardless of "Lock Monitoring Status 24.40".

4.3.1.10 System A Voltage Increase

General notes

Voltage is monitored depending on parameter "Monitoring" (parameter 8806 ↗ p. 92). This function allows the monitoring of the voltage quality over a longer time period. It is realized as a 10 minute moving average¹. The function is only active, if system A is within the operation window. If "SyA. voltage measuring" (parameter 1853 ↗ p. 77) is configured to a three-phase measurement, the slow voltage increase alarm is monitoring the individual three-phase voltages of the system A according to parameter "AND characteristics" (parameter 8849 ↗ p. 92). The parameter "SyA. decoupling volt. incr." (parameter 8808 ↗ p. 92) determines if a voltage increase shall trigger a system A decoupling or not.



If this protective function is triggered, the display indicates "SyA. volt. increase". The alarm can be incorporated into the system A decoupling function.



The average is set to "SyA. rated voltage" (parameter 1766 ↗ p. 75) if:

- *Frequency is not in the operating range OR*
- *Monitoring (parameter 8806 ↗ p. 92) is "Off" OR*
- *"Monitoring lockable" is active (parameter 8833 ↗ p. 92) OR*
- *Monitoring is tripped AND the measured voltage is again in the operating range*

Back synchronization is only possible, if:

- *The 10 minute average value is smaller than the defined limit AND*
- *The actual measured value is inside the operating range AND*
- *The system A settling time is over*



Please be aware that if "SyA. voltage monitoring" (parameter 1771 ↗ p. 79) is configured to "All" and the system A voltage increase monitoring (parameter 8806 ↗ p. 92) is used, that this function only monitors "Phase - neutral".



¹ Please be aware that this monitoring function was changed with software version 1.01xx or higher. For an older version of this manual please contact our sales support.

ID	Parameter	CL	Setting range [Default]	Description
8806	Monitoring	2	On	Voltage increase monitoring is carried out according to the following parameters.
			[Off]	No monitoring is carried out.
8807	Limit	2	100 to 150 % [110 %]	The percentage voltage value that is to be monitored is defined here. If the average voltage over 10 minutes is higher, the action specified by the alarm class is initiated.
			Notes This value refers to the "SyA. rated voltage" (parameter 1766 ↗ p. 75).	
8808	SyA. decoupling voltage increase	2	Yes	Voltage increase monitoring does cause decoupling.
			[No]	Voltage increase monitoring does not cause decoupling.
8831	Alarm class	2	Class A/B/C/D/E/F/Control [B]	Each limit may be assigned an independent alarm class that specifies what action should be taken when the limit is surpassed.
			Notes For additional information refer to ↗ Chapter 9.4.1 "Alarm Classes" on page 384	
8832	Self acknowledge	2	[Yes]	The control unit automatically clears the alarm if the fault condition is no longer detected.
			No	The control unit does not automatically reset the alarm when the fault condition is no longer detected. The alarm must be acknowledged and reset by manually pressing the appropriate buttons or by activating the LogicsManager output "External acknowledgement" (via a discrete input or via an interface).
8833	Monitoring lockable	2	Yes	Monitoring for fault conditions is only performed if "Lock Monitoring Status 24.40" is false
			[No]	Monitoring for this fault condition is continuously enabled regardless of "Lock Monitoring Status 24.40".
8849	AND characteristics	2	On	If the 10 minute voltage averages of all phases exceed the limit, the monitoring is tripping.
			[Off]	If the 10 minute voltage average of at least one phase exceeds the limit, the monitoring is tripping.

4.3.1.11 Setup System A for VDE-AR-N 4105

General notes

The German Grid Code VDE-AR-N 4105 instructs the handling of electrical energy sources running parallel to the low voltage grid. This rule has an impact with some items on the genset control. A more detailed description relating to that VDE rule is done through the separated application note "DE37671 easYgen-3000_LS5_VDE-AR-N 4105" on the manual CD of this product.

Here are some functions which have to be covered according to the VDE-AR-N 4105 rule:

- The mains decoupling is executed through following monitors:
 - Mains under voltage V<
 - Mains over voltage V>
 - Mains under frequency f<
 - Mains over frequency f>
 - Mains voltage increase
- Recognizing isolation operation (other decoupling argument)
 - Phase shift OR
 - df/dt
- Button for Testing the Decoupling Facility
- Single-failure-security including self-monitoring

The VDE-AR-N 4105 demands a Single-failure-proof of the mains decoupling function. That means that the decoupling of the generator from the mains must be always ensured, even if a single element in the system fails. So the system must contain two circuit breakers with two independent monitoring functions acting individually on each breaker. From the perspective of the network provider that rule pursues the mains protection but not the availability of the electrical source, so in case of doubt the generator should be decoupled from mains.

Woodward solves this requirement with the use of a minimum of two devices acting as a system (for example two LS-5 or an easYgen with VDE-AR-N 4105 functionality and an LS-5). The system allows incorporating more devices, so that the availability of the generator can still be increased.

The demanded two breakers in series are realized by the use of a GCB and an MCB. If only a GCB is available, the customer must install another circuit breaker in addition. If a breaker with LS-5 is installed between GCB and mains, the LS-5 can take over the part of the second device acting on the MCB. It also is allowed to use 2 LS-5 devices in series acting on two breakers, so the easYgen with its GCB would not be incorporated. This depends on the application for sure. Please refer to chapter [Chapter 6.1 "Application Modes Overview"](#) on page 189 for more information.

An important item of the VDE-AR-N 4105 is the Single-Failure-Diagnostic, at which a minimum of two devices exchange their measurement data and settings via communication interface (usually CANbus). This allows to determine whether the Single-Failure-Proof is lost and the device can issue an alarm.

Diagnostic via CAN interface

Devices with 4105 diagnostic check following items mutually:

1. Missing Member 4105 VDE-AR-N 4105

The Monitoring Missing Member checks whether there is minimum one additional 4105 partner device existing. If not, an alarm is triggered and displayed. The consequence is blocking or leaving the mains parallel operation, which can again be reached by changing the breaker transfer logic.

Alarm: Missing member 4105

2. Parameter Alignment VDE-AR-N 4105

The Monitoring Parameter Alignment checks whether all 4105 partner devices are configured with the same decoupling criteria. If not, an alarm is triggered and displayed. The consequence is blocking or leaving mains parallel operation, which can again be reached by changing the breaker transfer logic.

Alarm: Para.alignment 4105

The following parameters are criteria for decoupling and must have the same settings in all participating 4105 partner devices:

Monitoring	Parameter ID	Parameter
Mains Decoupling (SyA. decoupling)	3110	Mains Decoupling is released
Mains overfrequency level 2	2856	Monitoring
	2860	Limit
	2861	Delay
Mains underfrequency level 2	2906	Monitoring
	2910	Limit
	2911	Delay
Mains overvoltage level 2	2956	Monitoring
	2960	Limit
	2961	Delay
Mains undervoltage level 2	3006	Monitoring
	3010	Limit
	3011	Delay
Mains voltage increase	8806	Monitoring
	8808	Mains decoupling volt.incr.
	8807	Limit
Change of frequency	3058	Change of frequency (released via phase shift or df/dt)
	3054	Phase shift: Limit 1-phase (checked, if enabled)
	3055	Phase shift: Limit 3-phase (checked, if enabled)
	3104	df/dt: Limit (checked, if enabled)

Monitoring	Parameter ID	Parameter
	3105	df/dt: Delay (checked, if enabled)
Disable mains monitoring	15159	Disable mains monitoring Notes This LogicsManager is only available in the easYgen-3000XT and must be permanent FALSE. Otherwise the parameter alignment alarm will remain.

Table 24: VDE-AR-N 4105 alignment: Supervised parameters

3. Measurement Difference VDE-AR-N 4105

The Monitoring Measurement Difference checks whether the own mains voltage and mains frequency measurement matches with the one of the other 4105 partner. If not, there are two possible scenarios:

Scenario 1 - only one 4105 partner device exists: an alarm is triggered and displayed. The mains parallel operation is blocked.

Scenario 2 - multiple 4105 partner devices exist: an alarm is triggered and displayed by the device which is in the minority. This device blocks mains parallel operation. The other devices continue the operation and detect no alarm, because the Single-Failure-Proof is not lost.

Alarm: Meas.difference 4105

Enable VDE-AR-N 4105 monitoring

Monitoring according VDE AR-N 4105 per default is [Off]. It can be enabled via ToolKit "Configure Monitoring → System A → Setup 4105" or via Menu (see screenshot on the left).

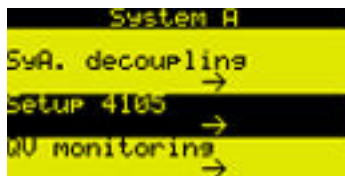

Fig. 59: Select Monitoring according VDE-AR-N 4105

Monitoring according VDE-AR-N 4105

ID	Parameter	CL	Setting range [Default]	Description
3297	Monitoring	2	[Off]	The diagnostic function is disabled, no related monitoring is executed.
			CAN 1	If the diagnostic function is enabled, the related messages can be received via CAN 1. Notes The following alarms can be triggered: <ul style="list-style-type: none"> ■ Missing member 4105 ■ Para. alignment 4105 ■ Meas.difference 4105
3298	Monitoring mode	2	Single	The diagnostic function is related to one partner device.

ID	Parameter	CL	Setting range [Default]	Description
			[Multi]	The diagnostic function is executed with according partner devices.
3299	Device number partner	2	[01] 01 to 64	The device ID of the expected partner device. This configuration is only valid, if the mode 'single' is enabled.
1828	Voltage difference	2	[4.0%] 2.0 to 9.9%	This is the voltage measurement tolerance for all participating VDE-AR-N 4105 partners relating to the mains rated voltage measurement (refer to parameter1768 ↗ p. 76). This is a part within the VDE-AR-N 4105 diagnostic.
1836	Frequency difference	2	[1.0%] 0.5 to 9.9%	This is the frequency measurement tolerance for all participating VDE-AR-N 4105 partners relating to the system rated frequency measurement. (refer to parameter1750 ↗ p. 75). This is a part within the VDE-AR-N 4105 diagnostic.
1888	Cascading delay	2	[0.0s] 0.0 to 99.9s	Additional decoupling delay time. With this time it is possible to cascade the decoupling between the VDE-AR-N 4105 devices.

Monitoring Missing Member VDE-AR-N 4105

ID	Parameter	CL	Setting range [Default]	Description
3478	Alarm class		[C] A to F, control	The alarm class specifies what action should be taken in case of missing communication with devices(s) being member(s) of the VDE-AR-N 4105 system. Notes For additional information refer to ↗ Chapter 9.4.1 "Alarm Classes" on page 384.
3479	Self acknowledge		Yes	The control automatically clears the alarm if the fault condition is no longer detected.
			[No]	The control device does not automatically reset the alarm when the fault condition is no longer detected. The alarm must be acknowledged and reset by manually pressing the appropriate buttons or by activating the LogicsManager output "External acknowledgment" (via a discrete input or via an interface).

Monitoring Parameter Alignment VDE-AR-N 4105

ID	Parameter	CL	Setting range [Default]	Description
3484	Alarm class	2	[C] A to F, control	The alarm class specifies what action should be taken if the parameter alignment between the communication devices(s) of the VDE-AR-N 4105 system is active. Notes For additional information refer to ↗ Chapter 9.4.1 "Alarm Classes" on page 384.
3485	Self acknowledge	2	Yes	The control automatically clears the alarm if the fault condition is no longer detected.
			[No]	The control device does not automatically reset the alarm when the fault condition is no longer detected. The alarm must be acknowledged and reset by manually pressing the appropriate buttons or by activating the LogicsManager output "External acknowledgment" (via a discrete input or via an interface).

Monitoring Measurement Difference VDE-AR-N 4105

ID	Parameter	CL	Setting range [Default]	Description
3490	Alarm class	2	[C] A to F, control	The alarm class specifies what action should be taken if the measurement difference (frequency, 1836 ↗ p. 96 or voltage, 1828 ↗ p. 96) between the communication devices(s) of the VDE-AR-N 4105 system differ more than allowed.
			Notes For additional information refer to ↗ Chapter 9.4.1 "Alarm Classes" on page 384.	
3491	Self acknowledge	2	Yes	The control automatically clears the alarm if the fault condition is no longer detected.
			[No]	The control device does not automatically reset the alarm when the fault condition is no longer detected. The alarm must be acknowledged and reset by manually pressing the appropriate buttons or by activating the LogicsManager output "External acknowledgment" (via a discrete input or via an interface).

4.3.1.12 QV Monitoring

General notes

In case of mains undervoltage some grid codes require a special monitoring function to avoid the import of inductive reactive power at the mains interchange point. The monitoring function measures close to system A. For this reason the QV monitoring is a function of system A voltage and system A reactive power.

QV monitoring is triggered if the following conditions are fulfilled.

- QV monitoring is configured to "On" (parameter 3292 ↗ p. 98)
- Measured reactive power is higher than the configured "Reactive power threshold" (parameter 3291 ↗ p. 98)
- Measured voltages are below the configured "Limit undervoltage" (parameter 3285 ↗ p. 98)

As a result Timer 1 and Timer 2 are starting. If the delay time "Delay step 1" (parameter 3283 ↗ p. 98) has exceeded, LogicsManager 07.29 becomes TRUE and the corresponding alarm message "SyA. QV monitoring 1" is indicated. If the delay time "Delay step 2" (parameter 3284 ↗ p. 98) has exceeded, LogicsManager 07.30 becomes TRUE and the corresponding alarm message "SyA. QV monitoring 2" is indicated.

If parameter "SyA. decoupling" (parameter 3295 ↗ p. 99) is configured to "On" the decoupling function is assigned to "Delay step 1" (parameter 3283 ↗ p. 98) or "Delay step 2" (parameter 3284 ↗ p. 98).



The LogicsManager command flags 07.29 and 07.30 can be additionally used to cause other actions according to the corresponding regulations of the grid.

Configuration

Configure Monitoring > System A > QV Monitoring

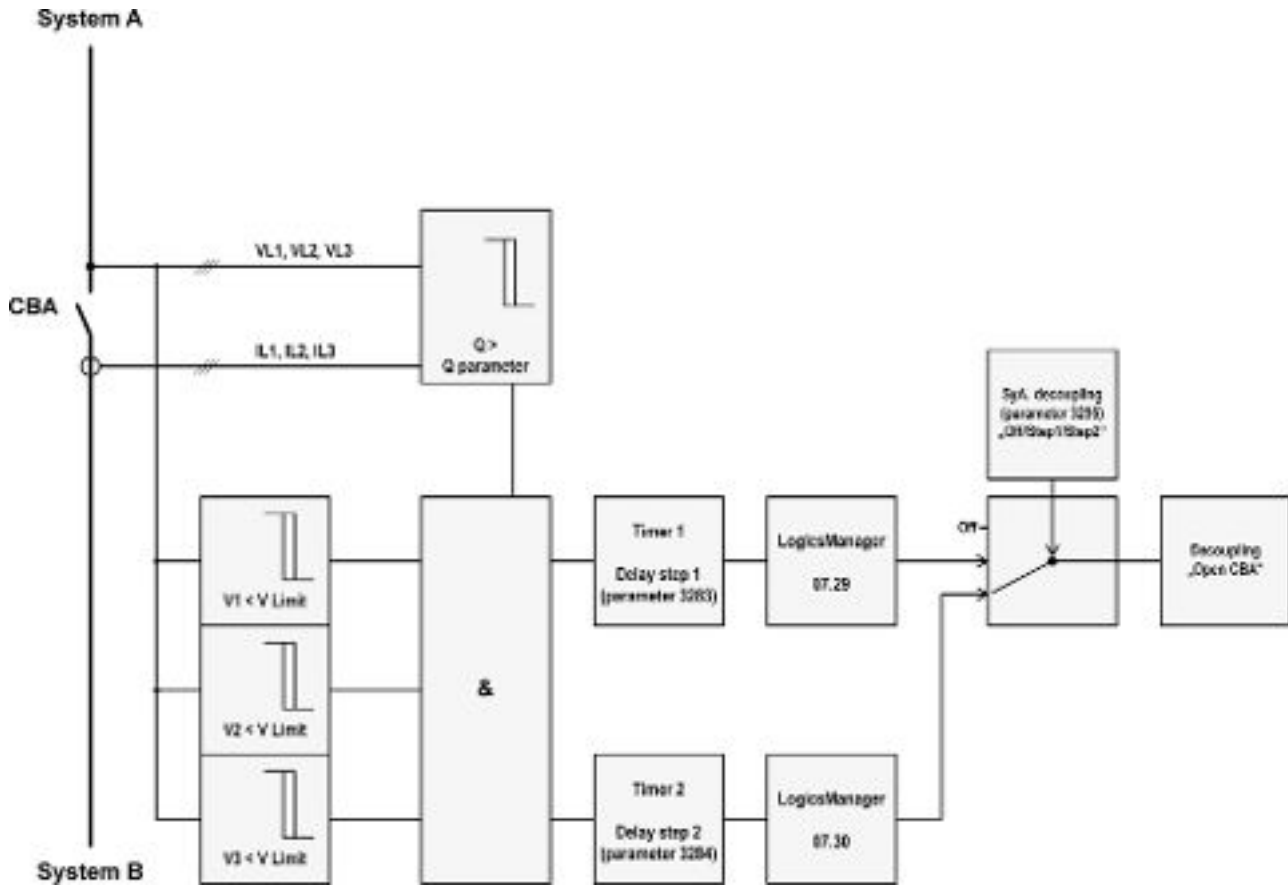

Fig. 60: QV monitoring - schematic

ID	Parameter	CL	Setting range [Default]	Description
3292	Monitoring	2	[On]	QV monitoring is carried out according to the following parameters.
			Off	No monitoring is carried out.
3285	Limit under-voltage	2	45 to 150 %	The percentage voltage value that is to be monitored is defined here.
			[85 %]	If the voltages of all phases (one phase in 1Ph 2W system) are below this limit, the voltage condition for tripping the monitoring function is TRUE.
				Notes This value refers to the "SyA. rated voltage" (parameter 1766 ↪ p. 75).
3291	Reactive power threshold	2	2 to 100 %	The percentage reactive value that is to be monitored is defined here.
			[5 %]	If the absolute value of reactive power Q is higher than this threshold, the reactive power condition for tripping the monitoring function is TRUE.
				Notes This value refers to the "SyA. rated react. power [kvar]" (parameter 1758 ↪ p. 75).
3283	Delay step 1	2	0.10 to 99.99 s	If the QV monitoring conditions are met, for the delay time configured here, an alarm "SyA. QV mon. 1" will be issued and LogicManager 07.29 becomes TRUE.
			[0.50 s]	
				Notes The decoupling function is only activated if "SyA. decoupling" (parameter 3295 ↪ p. 99) is configured to "Step 1".
3284	Delay step 2	2	0.10 to 99.99 s	If the QV monitoring conditions are met, for the delay time configured here, an alarm "SyA. QV mon. 2" will be issued and LogicManager 07.30 becomes TRUE.
			[1.50 s]	

ID	Parameter	CL	Setting range [Default]	Description
				Notes The decoupling function is only activated if "SyA. decoupling" (parameter 3295 ↗ p. 99) is configured to "Step 2".
3280	Alarm class	2	Class A/B/C/D/E/F/ Control [B]	The alarm class specifies what action should be taken when at least one delay has been exceeded. Notes For additional information refer to ↗ Chapter 9.4.1 "Alarm Classes" on page 384
3293	Self acknowledge	2	[Yes] No	The control unit automatically clears the alarm if the fault condition is no longer detected. The control unit does not automatically reset the alarm when the fault condition is no longer detected. The alarm must be acknowledged and reset by manually pressing the appropriate buttons or by activating the LogicsManager output "External acknowledgement" (via a discrete input or via an interface).
3294	Monitoring lockable	2	Yes [No]	Monitoring for fault conditions is only performed if Lock Monitoring Status 24.40 is false. Monitoring for this fault condition is continuously enabled regardless of Lock Monitoring Status 24.40.
3295	SyA. decoupling	2	[Off] Step 1 Step 2	The QV monitoring function is ignored in the decoupling function. Tripping of QV monitoring step 1 causes decoupling Tripping of QV monitoring step 2 causes decoupling

4.3.1.13 System A Time-Dependent Voltage

General notes

Voltage is monitored depending on parameter "SyA. voltage measuring" (parameter 1851 ↗ p. 76). This monitoring function is supporting a dynamic stabilization of mains. For this reason a FRT (Fault-Ride-Through) curve can be defined.

Furthermore it can be configured either as undervoltage or over-voltage monitoring (parameter 4953 ↗ p. 100). If the measured voltage of at least one phase (depends on the settings of parameter 4952 ↗ p. 100) falls below/exceeds the configured "Initial threshold" (parameter 4970 ↗ p. 101), the time-dependent voltage monitoring sequence starts and the voltage threshold will change in time according to the configured threshold curve points.

If the measured voltage falls below/exceeds this curve, the monitoring function triggers and LogicsManager 07.28 becomes TRUE. The system A decoupling function became active, if configured. If the measured voltage falls below/exceeds the configured "Fallback threshold" (parameter 4978 ↗ p. 101) for at least the configured "Fallback time" (parameter 4968 ↗ p. 101), the time-dependent voltage monitoring sequence will be reset.

The threshold curve results from seven configurable points and a linear interpolation between these points. Fig. 61 shows the default FRT curve for time-dependent voltage monitoring. The curve shows the device default values according to a typical grid code requirement.



The time points should always have an ascending order. The fallback threshold (parameter 4978 ↪ p. 101) should always be configured to a value higher/lower than the initial threshold (parameter 4970 ↪ p. 101).

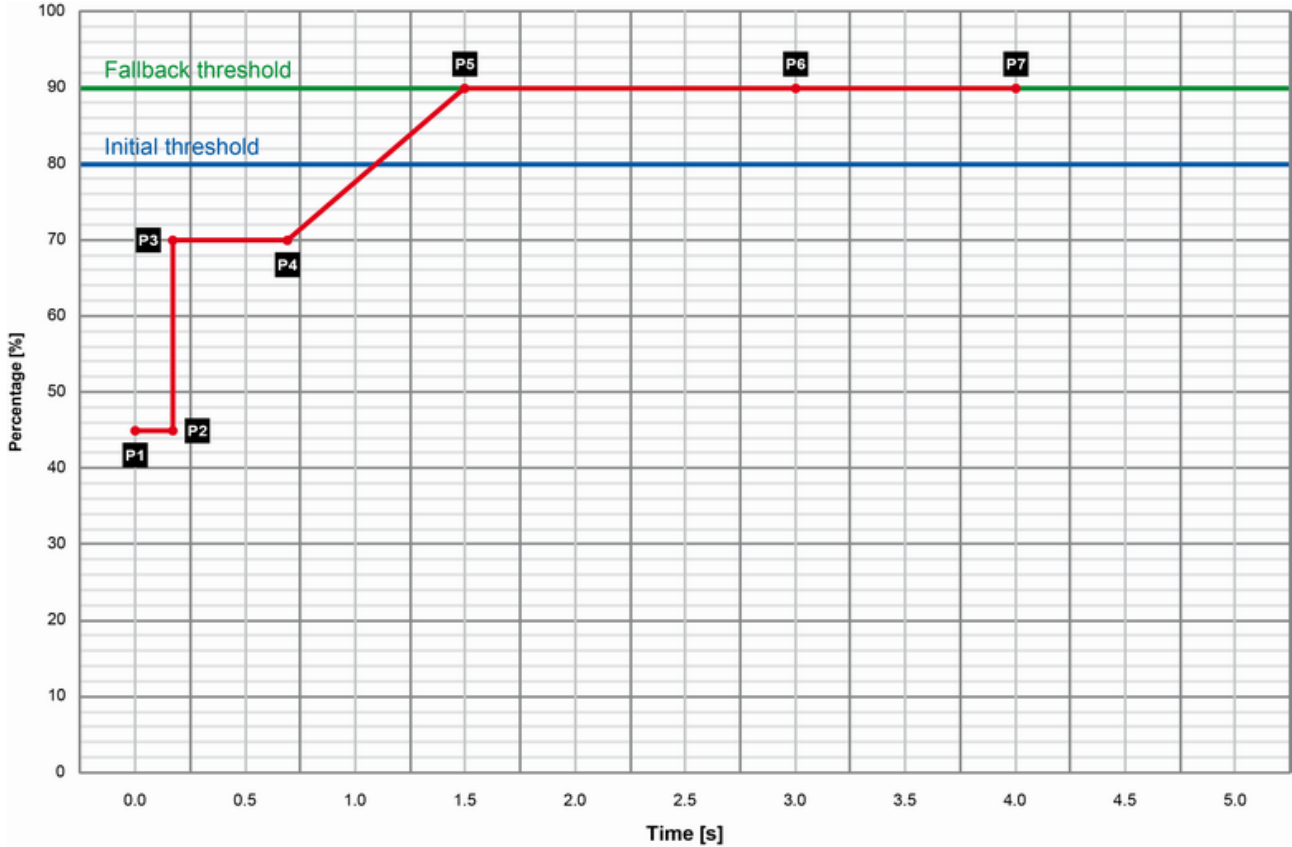

Fig. 61: Time-dependent voltage monitoring

P1	0.00 s → 45.0 %	P6	3.00 s → 90.0 %
P2	0.15 s → 45.0 %	P7	4.00 s → 90.0 %
P3	0.15 s → 70.0 %	Fallback threshold	90.0 %
P4	0.70 s → 70.0 %	Initial threshold	80.0 %
P5	1.50 s → 90.0 %	Fallback time	1.00 s

ID	Parameter	CL	Setting range [Default]	Description
4950	Monitoring	2	On	Time-dependent voltage monitoring is carried out according to the following parameters.
			[Off]	No monitoring is carried out.
4952	AND characteristics	2	On	Each phase falls below/exceeds the threshold for tripping.
			[Off]	At least one phase falls below/exceeds the threshold for tripping.
4953	Monitoring at	2		Selects whether the system shall do over- or undervoltage monitoring.
			[Underrun]	The undervoltage monitoring is carried out (The monitoring function triggers if the measured voltage is below the curve).
			Overrun	The overvoltage monitoring is carried out (The monitoring function triggers if the measured voltage exceeds the curve).

ID	Parameter	CL	Setting range [Default]	Description
4970	Init threshold	2	0.0 to 150.0 % [80.0 %]	<p>The time-dependent voltage monitoring initial threshold is configured here. If the measured voltage falls below/exceeds this threshold, the monitoring sequence starts and the voltage threshold will change in time according to the configured threshold curve points.</p> <p>If the measured voltage falls below/exceeds this curve, the monitoring function triggers and the configured relay will energize.</p>
4978	Fallback threshold	2	0.0 to 150.0 % [90.0 %]	<p>The time-dependent voltage monitoring fallback voltage is configured here. If the measured voltage falls below/exceeds the voltage configured here for at least the configured "Fallback time" (parameter 4968 ↗ p. 101), the monitoring sequence will be reset.</p> <p>Notes</p> <p>This parameter should always be configured to a value higher/lower than the "Init threshold" (parameter 4970 ↗ p. 101) for proper operation.</p> <p>The parameter "Point 7 voltage" (parameter 4977 ↗ p. 101) is used as fallback threshold if it is configured to a value higher/lower than the parameter "Fallback threshold" (parameter 4978 ↗ p. 101).</p>
4968	Fallback time	2	0.00 to 320.00 s [1.00 s]	<p>The time-dependent voltage monitoring fallback time is configured here. If the measured voltage falls below/exceeds the configured "Fallback threshold" (parameter 4978 ↗ p. 101) for at least the time configured here, the monitoring sequence will be reset.</p>
4961	Point {x} time [x = 1 to 7]	2	0.00 to 320.00 s	<p>The time values of time-dependent voltage monitoring time points are configured here.</p>
4962			4961: [0.00 s]	
4963			4962: [0.15 s]	
4964			4963: [0.15 s]	
4965			4964: [0.70 s]	
4966			4965: [1.50 s]	
4967			4966: [3.00 s] 4967: [4.00 s]	
4971	Point {x} voltage [x = 1 to 7]	2	0.0 to 150.0 %	<p>The voltage values of time-dependent voltage monitoring voltage points are configured here.</p>
4972			4971: [45.0 %]	
4973			4972: [45.0 %]	
4974			4973: [70.0 %]	
4975			4974: [70.0 %]	
4976			4975: [90.0 %]	
4977			4976: [90.0 %] 4977: [90.0 %]	
				<p>Notes</p> <p>Please avoid a setting between 0.1 % and 5.0 %.</p>
4951	Alarm class	2	Class A/B/C/D/E/F/ Control [B]	<p>Each limit may be assigned an independent alarm class that specifies what action should be taken when the limit is surpassed.</p> <p>Notes</p> <p>For additional information refer to ↗ Chapter 9.4.1 "Alarm Classes" on page 384</p>
4959	Self acknowledge	2	[Yes]	<p>The control unit automatically clears the alarm if the fault condition is no longer detected.</p>
			No	<p>The control unit does not automatically reset the alarm when the fault condition is no longer detected.</p> <p>The alarm must be acknowledged and reset by manually pressing the appropriate buttons or by activating the LogicsManager output "External acknowledgement" (via a discrete input or via an interface).</p>

ID	Parameter	CL	Setting range [Default]	Description
4999	Monitoring lockable	2	Yes	Monitoring for fault conditions is only performed if "Lock Monitoring Status 24.40" is false.
			[No]	Monitoring for this fault condition is continuously enabled regardless of "Lock Monitoring Status 24.40".
4989	SyA. decoupling	2	On	Time-dependent voltage monitoring does cause decoupling.
			[Off]	Time-dependent voltage monitoring does not cause decoupling.

4.3.1.14 System A Phase Rotation

General notes



NOTICE!

Damage to the control unit and/or generation equipment

- Ensure that the control unit is properly connected to phase voltages on both sides of the circuit breaker(s) during installation.

Failure to do so may result in damage to the control unit and/or generation equipment due to the breaker closing asynchronously or with mismatched phase rotations. Also ensure that phase rotation monitoring is enabled at all connected components (generator, breakers, cable, busbars, etc.).

This function will block a connection of systems with wrong phases only under the following conditions:

- The voltages being measured are wired correctly with respect to the phase rotation at the measuring points (i.e. the potential transformers in on both sides of the circuit breaker)
- The voltages being measured are wired so that angular phase shifts or any interruptions from the measuring point to the control unit do not exist
- The voltages being measured are wired to the correct terminals of the control.
- The configured alarm class is of class C or D (breaker relevant alarm).

Correct phase rotation of the phase voltages ensures that damage will not occur during a breaker closure. The voltage phase rotation alarm checks the phase rotation of the measured voltages and the configured phase rotation to ensure they are identical.

The directions of rotation are differentiated as "clockwise" and "counter clockwise". With a clockwise field the direction of rotation is "L1-L2-L3"; with a counter clockwise field the direction of rotation is "L1-L3-L2".

If the control is configured for a clockwise rotation and the voltages into the unit are calculated as counterclockwise the alarm will be initiated. The direction of configured rotation being monitored by the control unit is displayed on the screen.



If this protective function is triggered, the display indicates "SyA. phase rotation" and the logical command variable "07.05" will be enabled.



This monitoring function is only enabled if system A voltage measuring (parameter 1853 ↗ p. 77) is configured to "3Ph 4W" or "3Ph 3W" and the measured voltage exceeds 50 % of the rated voltage (parameter 1768 ↗ p. 76) or if system A voltage measuring (parameter 1853 ↗ p. 77) is configured to "1Ph 2W" (in this case, the phase rotation is not evaluated, but defined by the 1Ph2W phase rotation (parameter 1859 ↗ p. 76)).

ID	Parameter	CL	Setting range [Default]	Description
3970	Monitoring	2	[On]	Phase rotation monitoring is carried out according to the following parameters.
			Off	No monitoring is carried out.
3974	SyA. phase rotation	2	[CW]	The three-phase measured system A voltage is rotating CW (clock-wise; that means the voltage rotates in L1-L2-L3 direction; standard setting).
			CCW	The three-phase measured system A voltage is rotating CCW (counter clock-wise; that means the voltage rotates in L1-L3-L2 direction).
3971	Alarm class	2	Class A/B/C/D/E/F/Control [B]	Each limit may be assigned an independent alarm class that specifies what action should be taken when the limit is surpassed.
				Notes For additional information refer to ↗ Chapter 9.4.1 "Alarm Classes" on page 384
3972	Self acknowledge	2	Yes	The control unit automatically clears the alarm if the fault condition is no longer detected.
			[No]	The control unit does not automatically reset the alarm when the fault condition is no longer detected. The alarm must be acknowledged and reset by manually pressing the appropriate buttons or by activating the LogicsManager output "External acknowledgement" (via a discrete input or via an interface).
3973	Monitoring lockable	2	Yes	Monitoring for fault conditions is only performed if "Lock Monitoring Status 24.40" is false.
			[No]	Monitoring for this fault condition is continuously enabled regardless of "Lock Monitoring Status 24.40".

4.3.2 System B

ID	Parameter	CL	Setting range [Default]	Description
1770	SyB. voltage monitoring	2		The unit can either monitor the phase-neutral (wye) voltages or the phase-phase (delta) voltages. If the controller is used in a compensated or isolated network, voltage protection monitoring should be configured as phase-neutral to prevent earth-faults resulting in tripping of the voltage protections.
			[Phase - phase]	The phase-phase voltage will be monitored and all subsequent parameters concerning voltage monitoring "system B" are referred to this value (VL-L).
			Phase - neutral	The phase-neutral voltage will be monitored and all subsequent parameters concerning voltage monitoring "system B" are referred to this value (VL-N).
			Notes	Notes WARNING: This parameter influences the protective functions.

4.3.2.1 System B Operating Voltage / Frequency

General notes



The operating voltage/frequency parameters are used to check if the values are in range when performing a dead bus closure and synchronization.

It is recommended to configure the operating limits within the monitoring limits.

ID	Parameter	CL	Setting range [Default]	Description
5800	Upper voltage limit	2	100 to 150 % [110 %]	The maximum permissible positive deviation of the system B voltage from the system B rated voltage (parameter 1768 ↗ p. 76) is configured here. This value may be used as a voltage limit switch. The conditional state of this switch may be used as a command variable for the LogicsManager (02.03).
5801	Lower voltage limit	2	50 to 100 % [90 %]	The maximum permissible negative deviation of the system B voltage from the system B rated voltage (parameter 1768 ↗ p. 76) is configured here. This value may be used as a voltage limit switch. The conditional state of this switch may be used as a command variable for the LogicsManager (02.03).
5802	Upper frequency limit	2	100.0 to 150.0 % [105.0 %]	The maximum permissible positive deviation of the system B frequency from the rated system frequency (parameter 1750 ↗ p. 75) is configured here. This value may be used as a frequency limit switch. The conditional state of this switch may be used as a command variable for the LogicsManager (02.04).
5803	Lower frequency limit	2	50.0 to 100.0 % [95.0 %]	The maximum permissible negative deviation of the system B frequency from the rated system frequency (parameter 1750 ↗ p. 75) is configured here. This value may be used as a frequency limit switch. The conditional state of this switch may be used as a command variable for the LogicsManager (02.04).

4.3.2.2 System B Voltage Phase Rotation

General notes

**NOTICE!****Damage to the control unit and/or generation equipment**

- Ensure that the control unit is properly connected to phase voltages on both sides of the circuit breaker(s) during installation.

Failure to do so may result in damage to the control unit and/or generation equipment due to the breaker closing asynchronously or with mismatched phase rotations. Also ensure that phase rotation monitoring is enabled at all connected components (generator, breakers, cable, busbars, etc.).

This function will block a connection of systems with wrong phases only under the following conditions:

- The voltages being measured are wired correctly with respect to the phase rotation at the measuring points (i.e. the potential transformers in on both sides of the circuit breaker)
- The voltages being measured are wired so that angular phase shifts or any interruptions from the measuring point to the control unit do not exist
- The voltages being measured are wired to the correct terminals of the control.
- The configured alarm class is of class C or D (breaker relevant alarm).

Correct phase rotation of the phase voltages ensures that damage will not occur during a breaker closure to either the mains or the generator. The voltage phase rotation alarm checks the phase rotation of the voltages and the configured phase rotation to ensure they are identical.

The directions of rotation are differentiated as "clockwise" and "counter clockwise". With a clockwise field the direction of rotation is "L1-L2-L3"; with a counter clockwise field the direction of rotation is "L1-L3-L2".

If the control is configured for a clockwise rotation and the voltages into the unit are calculated as counterclockwise the alarm will be initiated. The direction of configured rotation being monitored by the control unit is displayed on the screen.



If this protective function is triggered, the display indicates "SyB. phase rotation" and the logical command variable "06.21" will be enabled.



This monitoring function is only enabled if "SyB. voltage measuring" (parameter 1851 ↗ p. 76) is configured to "3Ph 4W" or "3Ph 3W" and the measured voltage exceeds 50 % of the rated voltage (parameter 1766 ↗ p. 75) or if "SyB. voltage measuring" (parameter 1851 ↗ p. 76) is configured to "1Ph 2W" (in this case, the phase rotation is not evaluated, but defined by the 1Ph2W phase rotation (parameter 1859 ↗ p. 76)).

ID	Parameter	CL	Setting range [Default]	Description
3950	Monitoring	2	On	Phase rotation monitoring is carried out according to the following parameters.
			[Off]	No monitoring is carried out.
3954	SyB. phase rotation	2	[CW]	The three-phase measured system B voltage is rotating CW (clock-wise; that means the voltage rotates in L1-L2-L3 direction; standard setting).
			CCW	The three-phase measured system B voltage is rotating CCW (counter clock-wise; that means the voltage rotates in L1-L3-L2 direction).
3951	Alarm class	2	Class A/B/C/D/E/F/Control [F]	Each limit may be assigned an independent alarm class that specifies what action should be taken when the limit is surpassed.
				Notes For additional information refer to ↗ Chapter 9.4.1 "Alarm Classes" on page 384
3952	Self acknowledge	2	Yes	The control unit automatically clears the alarm if the fault condition is no longer detected.
			[No]	The control unit does not automatically reset the alarm when the fault condition is no longer detected. The alarm must be acknowledged and reset by manually pressing the appropriate buttons or by activating the LogicsManager output "External acknowledgement" (via a discrete input or via an interface).
3953	Monitoring lockable	2	Yes	Monitoring for fault conditions is only performed if "Lock Monitoring Status 24.40" is false.
			[No]	Monitoring for this fault condition is continuously enabled regardless of "Lock Monitoring Status 24.40".

4.3.3 Breaker

4.3.3.1 CBA

General notes

Circuit breaker monitoring contains two alarms: A "breaker close" alarm and a "breaker open" alarm.

"Breaker close alarm"

If the control initiates a close of the breaker and the breaker fails to close after the configured number of attempts the monitoring CBA alarm will be initiated (refer to parameter "CBA maximum attempts of closure", parameter 3419 ↗ p. 107).



If this protective function is triggered, the display indicates "CBA fail to close" and the logical command variable "08.07" will be enabled.

"Breaker open alarm"

If the control is attempting to open the circuit breaker and it fails to see that the CBA is open within the configured time in seconds after issuing the breaker open command then the monitoring CBA alarm will be initiated (refer to parameter "CBA open monitoring", parameter 3421 ↗ p. 107).



If this protective function is triggered, the display indicates "CBA fail to open" and the logical command variable "08.08" will be enabled.

ID	Parameter	CL	Setting range [Default]	Description
2620	CBA monitoring	2	[On]	Monitoring of the CBA is carried out according to the following parameters.
			Off	Monitoring is disabled.
2621	CBA alarm class	2	Class A/B [B]	Each limit may be assigned an independent alarm class that specifies what action should be taken when the limit is surpassed.
			Notes For additional information refer to ↗ Chapter 9.4.1 "Alarm Classes" on page 384	
3419	CBA maximum attempts of closure	2	1 to 10 [5]	The maximum number of breaker closing attempts is configured in this parameter (relay output "Command: close CBA"). When the breaker reaches the configured number of attempts, a "CBA fail to close" alarm is issued. The counter for the closure attempts will be reset as soon as the "Reply CBA" is de-energized for at least 5 seconds to signal a closed CBA.
3421	CBA open monitoring	2	0.10 to 5.00 s [2.00 s]	If the "Reply CBA" is not detected as energized once this timer expires, a "CBA fail to open" alarm is issued. This timer initiates as soon as the "open breaker" sequence begins. The alarm configured in parameter 2621 ↗ p. 107 is issued.
2622	CBA monitoring lockable	2	Yes	Monitoring for fault conditions is only performed if "Lock Monitoring Status 24.40 is false".
			[No]	Monitoring for this fault condition is continuously enabled regardless of "Lock Monitoring Status 24.40".

4.3.3.2 Synchronization CBA



For synchronization with two systems please see additionally ↗ Chapter 9.5.1 "Synchronization Of System A and System B" on page 390.

Configuration

Configure Monitoring > Breaker > CBA Unload Mismatch

ID	Parameter	CL	Setting range [Default]	Description
3070	Monitoring	2	[On]	Monitoring of the CBA synchronization is carried out according to the following parameters.
			Off	Monitoring is disabled.
3073	Delay	2	3 to 999 s [60 s]	If it was not possible to synchronize the CBA within the time configured here, an alarm will be issued. The message "CBA syn. timeout" is issued and the logical command variable "08.31" will be enabled.
3071	Alarm class	2	Class A/B/C/D/E/F/ Control [B]	Each limit may be assigned an independent alarm class that specifies what action should be taken when the limit is surpassed.
				Notes For additional information refer to Chapter 9.4.1 "Alarm Classes" on page 384
3072	Self acknowledge	2	Yes	The control unit automatically clears the alarm if the fault condition is no longer detected.
			[No]	The control unit does not automatically reset the alarm when the fault condition is no longer detected. The alarm must be acknowledged and reset by manually pressing the appropriate buttons or by activating the LogicsManager output "External acknowledgement" (via a discrete input or via an interface).
3075	Monitoring lockable	2	Yes	Monitoring for fault conditions is only performed if "Lock Monitoring Status 24.40" is false.
			[No]	Monitoring for this fault condition is continuously enabled regardless of "Lock Monitoring Status 24.40".

4.3.3.3 CBA Unload Mismatch

ID	Parameter	CL	Setting range [Default]	Description
8819	Unload trip level CBA	2	0.5 to 99.9 % [3.0 %]	If the monitored power of system A falls below this value, a "CBA open" command will be issued.
				Notes This value refers to the "SyA. rated active power" (parameter 1752 p. 75).
8835	Delay	2	1 to 999 s [60 s]	If the monitored system A power does not fall below the limit configured in parameter 8819 p. 108 before the time configured here expires, a "CBA open" command will be issued together with an alarm "CBA unload mismatch" and the logical command variable "08.36" will be enabled.
8836	Alarm class	2	Class A/B/C/D/E/F/ Control [B]	Each limit may be assigned an independent alarm class that specifies what action should be taken when the limit is surpassed.
				Notes For additional information refer to Chapter 9.4.1 "Alarm Classes" on page 384
8837	Self acknowledge	2	Yes	The control unit automatically clears the alarm if the fault condition is no longer detected.

ID	Parameter	CL	Setting range [Default]	Description
			[No]	The control unit does not automatically reset the alarm when the fault condition is no longer detected. The alarm must be acknowledged and reset by manually pressing the appropriate buttons or by activating the LogicsManager output "External acknowledgement" (via a discrete input or via an interface).
8846	Monitoring lockable	2	Yes	Monitoring for fault conditions is only performed if "Lock Monitoring Status 24.40 is false."
			[No]	Monitoring for this fault condition is continuously enabled regardless of "Lock Monitoring Status 24.40".

4.3.3.4 System A / System B Phase Rotation

General notes

Correct phase rotation of the phase voltages ensures that damage will not occur during a breaker closure. The voltage phase rotation alarm checks, if the phase rotation of the measured voltage systems are identical.

If the control unit detects different phase rotations of system A and system B, the alarm will be initiated and a breaker synchronization is inhibited. However, this alarm will not prevent a dead busbar closure, i.e. a dead bus start.



If this protective function is triggered, the display indicates "Ph.rotation mismatch" and the logical command variable "08.33" will be enabled.



This monitoring function is only enabled if system A voltage measuring (parameter 1851 ↗ p. 76) and system B voltage measuring (parameter 1853 ↗ p. 77) are configured to "3Ph 4W" or "3Ph 3W" and the measured voltage exceeds 50 % of the rated voltage (parameter 1766 ↗ p. 75) or if system A voltage measuring (parameter 1851 ↗ p. 76) and system B voltage measuring (parameter 1853 ↗ p. 77) are configured to "1Ph 2W". In this case, the phase rotation is not evaluated, but defined by the 1Ph2W phase rotation (parameter 1859 ↗ p. 76).

ID	Parameter	CL	Setting range [Default]	Description
2940	Monitoring	2	[On]	Phase rotation monitoring is carried out according to the following parameters
			Off	Monitoring is disabled.
2941	Alarm class	2	Class A/B/C/D/E/F/ Control	Each limit may be assigned an independent alarm class that specifies what action should be taken when the limit is surpassed.
			[B]	Notes For additional information refer to ↗ Chapter 9.4.1 "Alarm Classes" on page 384

ID	Parameter	CL	Setting range [Default]	Description
2942	Self acknowledge	2	[Yes]	The control unit automatically clears the alarm if the fault condition is no longer detected.
			No	The control unit does not automatically reset the alarm when the fault condition is no longer detected. The alarm must be acknowledged and reset by manually pressing the appropriate buttons or by activating the LogicsManager output "External acknowledgement" (via a discrete input or via an interface).
2945	Monitoring lockable	2	Yes	Monitoring for fault conditions is only performed if "Lock Monitoring Status 24.40 is false".
			[No]	Monitoring for this fault condition is continuously enabled regardless of "Lock Monitoring Status 24.40".

4.3.4 Voltage plausibility

General notes

If there is a connection between System A and System B based on breaker feedbacks, the monitoring function compares the status flags of System A (logical command variable 02.11) and System B (logical command variable 02.05) on same condition. Additionally, if both systems are okay, the monitor expects to see a phase angle between both systems less than +/- 10°. The intension of this monitor is to detect wiring failures or blown fuses.

An alarm will be initiated if

- the status flags of System A (02.11) and System B (02.05) do not have the same condition
- the status flags of System A (02.11) and System B (02.05) have the same condition but the phase angle between both systems is too big



If this protective function is triggered, the display indicates "Voltage mismatch" and the logical command variable "08.47" will be enabled.

ID	Parameter	CL	Setting range [Default]	Description
2991	Monitoring	2	On	Voltage plausibility monitoring is carried out according to the following parameters.
			[Off]	Monitoring is disabled.
2995	Delay	2	1 to 999 s [30 s]	If the monitored conditions are met for the delay time configured here, an alarm will be issued.
2992	Alarm class	2	Class A/B/C/D/E/F/Control [B]	Each limit may be assigned an independent alarm class that specifies what action should be taken when the limit is surpassed.
				Notes For additional information refer to Chapter 9.4.1 "Alarm Classes" on page 384
2993	Self acknowledge	2	Yes	The control unit automatically clears the alarm if the fault condition is no longer detected.

ID	Parameter	CL	Setting range [Default]	Description
			[No]	The control unit does not automatically reset the alarm when the fault condition is no longer detected. The alarm must be acknowledged and reset by manually pressing the appropriate buttons or by activating the LogicsManager output "External acknowledgement" (via a discrete input or via an interface).
2994	Monitoring lockable	2	Yes	Monitoring for fault conditions is only performed if "Lock Monitoring Status 24.40 is false".
			[No]	Monitoring for this fault condition is continuously enabled regardless of "Lock Monitoring Status 24.40".

4.3.5 Operating range

General notes

The operating range monitoring signalizes a wrong behavior of the system. The device is blocked to continue. The reason for this often is a not reached operating range or a missing breaker feedback or release. The device indicates the root cause by issuing an additional error number. Each error number represents a different root cause. This shall provide assistance in troubleshooting.

If this protective function is triggered, the display indicates "Operating range {x}" and the following logical command variable will be enabled:



If there is more than one failure at the same time following operating range priority is used:

1 - 2 - 4 - 3

Command variable	Function	Conditions to trigger the alarm
08.48 Operating range 1	<p>CAN interface</p> <p>The LS-5 needs at least one other member. The alarm indicates that the LS-5 is blocked, because there is no other member on the CAN bus recognized.</p> <p>Notes</p> <p>This alarm is only active if the application mode CBA (parameter 8840 ↗ p. 120) is configured to "LS-5".</p>	<ul style="list-style-type: none"> ■ The command LM "Enable CBA to close" is TRUE ■ AND The CBA feedback is open ■ AND No CAN member is recognized
08.49 Operating range 2	<p>Synchronous networks</p> <p>The alarm indicates that the LS-5 is blocked, because there are synchronous networks or synchronous segment numbers on system A and system B side recognized. But the according configurations "Connect synchronous mains" (parameter 8820 ↗ p. 126) and "Connect synchronous segments" (parameter 8852 ↗ p. 127) do not allow that.</p>	<ul style="list-style-type: none"> ■ The command LM "Enable CBA to close" is TRUE ■ AND The CBA feedback is open ■ AND Synchronous mains or synchronous segments are detected but not allowed to connect.

Command variable	Function	Conditions to trigger the alarm
	<p>Notes</p> <p>This alarm is only active if the application mode CBA (parameter 8840 ↗ p. 120) is configured to "LS-5".</p>	
08.50 Operating range 3	<p>CBA dead bus closure condition</p> <p>The alarm indicates that the LS-5 is blocked, because there is a dead busbar closure CBA situation recognized but the according configurations (parameter 8801 ↗ p. 120, 8802 ↗ p. 120, 8803 ↗ p. 121 and 8804 ↗ p. 121) do not allow a dead busbar closure CBA.</p>	<ul style="list-style-type: none"> ■ The command LM "Enable CBA to close" is TRUE ■ AND The CBA feedback is open ■ AND A CBA dead busbar closure is detected but not allowed to execute ■ AND The alarm class for opening the breaker is not active
08.51 Operating range 4	<p>CBA synchronization</p> <p>The alarm indicates that the LS-5 is blocked, because there is a CBA synchronization situation recognized but the System A or System B does not match the operating ranges.</p>	<ul style="list-style-type: none"> ■ The command LM "Enable CBA to close" is TRUE ■ AND The CBA feedback is open ■ AND The System A or B is not in range for synchronization ■ AND The alarm class for opening the breaker CBA is not active

ID	Parameter	CL	Setting range [Default]	Description
2660	Monitoring	2	[On]	Operating range monitoring is carried out according to the following parameters.
			Off	Monitoring is disabled.
2663	Delay	2	1 to 999 s [30 s]	If one of the above mentioned conditions for an operating range failure is fulfilled for the delay time configured here, the appropriate alarm will be issued.
2661	Alarm class	2	Class A/B/C/D/E/F/ Control [B]	Each limit may be assigned an independent alarm class that specifies what action should be taken when the limit is surpassed.
				<p>Notes</p> <p>For additional information refer to ↗ <i>Chapter 9.4.1 "Alarm Classes" on page 384</i></p>
2662	Self acknowledge	2	Yes	The control unit automatically clears the alarm if the fault condition is no longer detected.
			[No]	<p>The control unit does not automatically reset the alarm when the fault condition is no longer detected.</p> <p>The alarm must be acknowledged and reset by manually pressing the appropriate buttons or by activating the LogicsManager output "External acknowledgement" (via a discrete input or via an interface).</p>
2678	Monitoring lockable	2	Yes	Monitoring for fault conditions is only performed if "Lock Monitoring Status 24.40 is false".
			[No]	Monitoring for this fault condition is continuously enabled regardless of "Lock Monitoring Status 24.40".

4.3.6 CAN Interface

General notes

The CANopen interface is monitored. If the interface does not receive a Receive Process Data Object (RPDO) before the delay expires, an alarm will be initiated.



If this protective function is triggered, the display indicates "CANopen interface 1" and the logical command variable "08.18" will be enabled.

ID	Parameter	CL	Setting range [Default]	Description
3150	Monitoring	2	On	CANopen interface monitoring is carried out according to the following parameters.
			[Off]	Monitoring is disabled.
3154	Delay	2	0.01 to 650.00 s [0.20 s]	The maximum receiving break is configured with this parameter. If the interface does not receive an RPDO within this time, the action specified by the alarm class is initiated. The delay timer is re-initialized after every message is received.
3151	Alarm class	2	Class A/B/C/D/E/F/Control [B]	Each limit may be assigned an independent alarm class that specifies what action should be taken when the limit is surpassed.
				Notes For additional information refer to Chapter 9.4.1 "Alarm Classes" on page 384
3152	Self acknowledge	2	[Yes]	The control unit automatically clears the alarm if the fault condition is no longer detected.
			No	The control unit does not automatically reset the alarm when the fault condition is no longer detected. The alarm must be acknowledged and reset by manually pressing the appropriate buttons or by activating the LogicsManager output "External acknowledgement" (via a discrete input or via an interface).
3153	Monitoring lockable	2	Yes	Monitoring for fault conditions is only performed if "Lock Monitoring Status 24.40 is false".
			[No]	Monitoring for this fault condition is continuously enabled regardless of "Lock Monitoring Status 24.40".

4.3.7 Battery Overvoltage (Level 1 & 2)

General notes

There are two battery overvoltage alarm levels available in the control. Both alarms are definite time alarms and. Monitoring of the voltage is done in two steps.



If this protective function is triggered, the display indicates "Bat. overvoltage 1" or "Bat. overvoltage 2" and the logical command variable "08.01" or "08.02" will be enabled.

Refer to [Chapter 9.1.1 "Triggering Characteristics"](#) on page 271 for the triggering characteristic of this monitoring function.

ID	Parameter	CL	Setting range [Default]	Description
3450 3456	Monitoring	2	[On]	Overvoltage monitoring of the battery voltage is carried out according to the following parameters. Both values may be configured independent from each other (prerequisite: Level 1 > Level 2).
Off			Monitoring is disabled for Level 1 limit and/or Level 2 limit.	
3454 3460	Limit	2	8.0 to 42.0 V	The threshold values that are to be monitored are defined here.
			3454: [32.0 V] 3460: [35.0 V]	If the monitored battery voltage reaches or exceeds this value for at least the delay time without interruption, the action specified by the alarm class is initiated.
3455 3461	Delay	2	0.02 to 99.99 s	If the monitored battery voltage exceeds the threshold value for the delay time configured here, an alarm will be issued.
			3455: [5.00 s] 3461: [1.00 s]	
				Notes If the monitored battery voltage falls below the threshold (minus the hysteresis) before the delay expires the time will be reset.
3451 3457	Alarm class	2	Class A/B/C/D/E/F/ Control [B]	Each limit may be assigned an independent alarm class that specifies what action should be taken when the limit is surpassed.
				Notes For additional information refer to Chapter 9.4.1 "Alarm Classes" on page 384
3452 3458	Self acknowledge	2	[Yes]	The control unit automatically clears the alarm if the fault condition is no longer detected.
			No	The control unit does not automatically reset the alarm when the fault condition is no longer detected. The alarm must be acknowledged and reset by manually pressing the appropriate buttons or by activating the LogicsManager output "External acknowledgement" (via a discrete input or via an interface).
3453 3459	Monitoring lockable (Limit 1 / Limit 2)	2	[Yes]	Monitoring for fault conditions is only performed if "Lock Monitoring Status 24.40 is false".
			No	Monitoring for this fault condition is continuously enabled regardless of "Lock Monitoring Status 24.40".

4.3.8 Battery Undervoltage (Level 1 & 2)

General notes

There are two battery undervoltage alarm levels available in the control. Both alarms are definite time alarms. Monitoring of the voltage is done in two steps.



If this protective function is triggered, the display indicates "Bat. undervoltage 1" or "Bat. undervoltage 2" and the logical command variable "08.03" or "08.04" will be enabled.

Refer to [Chapter 9.1.1 "Triggering Characteristics" on page 271](#) for the triggering characteristic of this monitoring function.

ID	Parameter	CL	Setting range [Default]	Description
3500 3506	Monitoring	2	[On]	Undervoltage monitoring of the battery voltage is carried out according to the following parameters. Both values may be configured independent from each other (prerequisite: Level 1 > Level 2).
Off			Monitoring is disabled for Level 1 limit and/or Level 2 limit.	
3504 3510	Limit	2	8.0 to 42.0 V	The threshold values that are to be monitored are defined here.
			3404: [24.0 V] 3510: [20.0 V]	If the monitored battery voltage reaches or falls below this value for at least the delay time without interruption, the action specified by the alarm class is initiated.
<p>Notes</p> <p>The default monitoring limit for battery undervoltage is 24 Vdc after 60 seconds.</p> <p>This is because in normal operation the terminal voltage is approximately 26 Vdc (alternator charged battery).</p>				
3505 3511	Delay	2	0.02 to 99.99 s	If the battery voltage falls below the threshold value for the delay time configured here, an alarm will be issued.
			3405: [60.00 s] 3511: [10.00 s]	
<p>Notes</p> <p>If the battery voltage exceeds the threshold (plus the hysteresis) again before the delay expires the time will be reset.</p>				
3501 3507	Alarm class	2	Class A/B/C/D/E/F/ Control	Each limit may be assigned an independent alarm class that specifies what action should be taken when the limit is surpassed.
			[B]	
<p>Notes</p> <p>For additional information refer to Chapter 9.4.1 "Alarm Classes" on page 384</p>				
3502 3508	Self acknowledge	2	Yes	The control unit automatically clears the alarm if the fault condition is no longer detected.
			[No]	The control unit does not automatically reset the alarm when the fault condition is no longer detected.
<p>The alarm must be acknowledged and reset by manually pressing the appropriate buttons or by activating the LogicsManager output "External acknowledgement" (via a discrete input or via an interface).</p>				
3503 3509	Monitoring lockable	2	Yes	Monitoring for fault conditions is only performed if "Lock Monitoring Status 24.40 is false".
			[No]	Monitoring for this fault condition is continuously enabled regardless of "Lock Monitoring Status 24.40".

4.3.9 Free Configurable Alarms

General Notes

The LS-5 v2 series devices provide 4 freely configurable alarms.

Each alarm is configurable by:

- Alarm text/"Description" (configurable with ToolKit only)
- "Monitoring" switch
- Selectable "Monitoring source"
- "Delay" time
- "Alarm class"
- "Self acknowledgment"
- "Monitoring lockable" switch

Free alarm 1 for example

ID	Parameter	CL	Setting range [Default]	Description
6680	Description	2	[Free alarm 1] ...((8/16/20/48 characters))*	Text is configurable by ToolKit.
			Notes *) The max. number of characters is 48 but 8/16/20 characters can be read on HMI depending on font and Byte per character.	
5160	Monitoring	2	On	Free alarm monitoring is carried out according to the following parameters.
			[Off]	No monitoring is carried out.
6684	Monitoring source	2	LM Flag {x} [x = 1 to 16]	Select source of monitoring.
5164	Delay	2	0.3 to 999.9 s	Period before alarm becomes TRUE.
			[5.0 s]	
5161	Alarm class	2	Class A/B/C/D/E/F, Control	The assigned independent alarm class specifies what action should be taken when the alarm becomes TRUE.
			[Class B]	
5162	Self acknowledge	2	Yes	The control automatically clears the alarm if the fault condition is no longer detected.
			[No]	The control does not automatically clears the alarm if the fault condition is no longer detected. The alarm must be acknowledged and reset by manually pressing the appropriate buttons or by activating the LogicsManager output "External acknowledgment" (via a discrete input or via an interface).
5163	Monitoring lockable	2	Yes	Monitoring for fault conditions is only performed if "Lock Monitoring Status 24.40" is false.
			[No]	Monitoring for this fault condition is continuously enabled regardless of "Lock Monitoring Status 24.40".

Parameter IDs

Free alarm #	Description	Monitoring	Monitoring source	Delay	Alarm class	Self acknowledge	Monitoring lockable
1	6680	5160	6684	5164	5161	5162	5163
2	6681	5166	6685	5170	5167	5168	5169
3	6682	5172	6686	5176	5173	5174	5175
4	6683	5178	6687	5182	5179	5180	5181

Table 25: Free alarms - parameter IDs

4.3.10 Multi-Unit Missing Members

General notes

The multi-unit missing members monitoring function checks whether all participating units are available (sending data on the CAN bus).

If the number of available units is less than the number of members configured in parameter 4063 ↗ p. 117 for at least the delay time, the display indicates "Missing members" and the logical command variable "08.17" will be enabled.



After energizing the unit, a delay is started, which allows a possible "Missing members" alarm to become active. This delay depends on the Node-ID of the unit (parameter 8950 ↗ p. 138) and the transfer rate of a load share / LS-5 fast message (parameter 9921 ↗ p. 137) and may last for approximately 140 seconds for a high Node-ID (e.g. 127). This delay serves for detecting the Master of a CAN bus connection. Approximately two minutes after energizing the unit, the alarm delay will be set to a fix time, which depends on the setting of parameter 9921 ↗ p. 137 (Transfer rate LS fast message) and is in the range between 3 to 9 seconds.

ID	Parameter	CL	Setting range [Default]	Description
4060	Monitoring	2	On	Multi-unit missing members monitoring is carried out.
			[Off]	Monitoring is disabled.
				Notes This parameter only applies to application mode
4063	Number of LS5 communicating	2	2 to 64	The number participating of LS-5 units is configured here.
			[2]	
4061	Alarm class	2	Class A/B/C/D/E/F/Control	This function may be assigned an independent alarm class that specifies what action should be taken when this function triggers an alarm.
			[B]	
4062	Self acknowledge	2	Yes	The control automatically clears the alarm if the fault condition is no longer detected.
			[No]	The control does not automatically reset the alarm when the fault condition is no longer detected. The alarm must be acknowledged and reset by manually pressing the appropriate buttons or by activating the LogicsManager output "External acknowledgement" (via a discrete input or via an interface).

4.3.11 Global settings

4.3.11.1 Alarm Acknowledgement

ID	Parameter	CL	Setting range [Default]	Description
1756	Time until horn reset	0	0 to 1,000 s	<p>After each alarm of alarm class B through F occurs, the alarm LED flashes and the horn (command variable 01.12) is enabled. After the delay time "time until horn reset" has expired, the flashing LED changes into a steady light and the horn (command variable 01.12) is disabled. The alarm LED flashes until the alarm has been acknowledged either via the push button, the Logics-Manager, or the interface.</p> <p>Notes</p> <p>If this parameter is configured to 0, the horn will remain active until it will be acknowledged.</p>
12490	Ext. acknowledge (External acknowledgment of alarms)	2	Determined by LogicsManager [[DI 02 & 1] & 1]	<p>It is possible to acknowledge all alarms simultaneously from remote, e.g. with a discrete input. The logical output of the LogicsManager has to become TRUE twice.</p> <p>The first time is for acknowledging the horn, the second for all alarm messages. The On-delay time is the minimum time the input signals have to be "1". The Off-delay time is the time how long the input conditions have to be "0" before the next high signal is accepted.</p> <p>Once the conditions of the LogicsManager have been fulfilled the alarms will be acknowledged.</p> <p>The first high signal into the discrete input acknowledges the command variable 01.12 (horn).</p> <p>The second high signal acknowledges all inactive alarm messages.</p> <p>Notes</p> <p>For information on the LogicsManager and its default settings see Chapter 9.3.1 "LogicsManager Overview" on page 354.</p>
12959	Lock Monitoring	2	Determined by LogicsManager [[DI 01 & 1] & 1]	<p>As long as the conditions of the LogicsManager have been fulfilled, all monitoring functions which are configured "Monitoring lockable" to "Yes" are locked.</p>

4.4 Configure Application

4.4.1 Application Mode

General notes

The unit can be configured to four different application modes. For additional information refer to [Chapter 6 "Application" on page 189](#).



*In the application modes **403** and **404** some parameters are fixed to the corresponding parameters in the easYgen.*

Fixed parameters



*In the application modes **A03** and **A04** some parameters are preconfigured to fixed values. In these modes these parameters cannot be accessed via front panel or ToolKit.*

- *Check the following parameters if you change the application mode from **A03** or **A04** to **A02** or **A01**.*





Device number (parameter 1702 ↗ p. 73)	Variable system (parameter 8816 ↗ p. 131)
Node-ID CAN bus 1 (parameter 8950 ↗ p. 138)	Synchronization mode (parameter 5728 ↗ p. 125)
Startup in mode (parameter 8827 ↗ p. 131)	Mains power measurement (parameter 8813 ↗ p. 130)
Isolation switch (parameter 8815 ↗ p. 131)	Dead bus closure (parameter 8801 ↗ p. 120)
Segment number System A (parameter 8810 ↗ p. 130)	Connect A dead to B dead (parameter 8802 ↗ p. 120)
Segment number System B (parameter 8811 ↗ p. 130)	Connect A dead to B alive (parameter 8803 ↗ p. 121)
Mains connection (parameter 8814 ↗ p. 130)	Connect A alive to B dead (parameter 8804 ↗ p. 121)
Open CBA in manual (parameter 8828 ↗ p. 121)	Connect synchronous mains (parameter 8820 ↗ p. 126)
Max. phase angle (parameter 8821 ↗ p. 127)	Delay time phi max. (parameter 8822 ↗ p. 127)

Hidden parameters



*The following parameters (LogicsManager) are hidden and have no impact in the application modes **A03** and **A04**.*

LM: Enable close CBA (parameter 12945 ↗ p. 122)	LM: Enable close CBA (24.34)
LM: Open CBA immediately (parameter 12944 ↗ p. 122)	LM: Open CBA immediately (24.33)
LM: Open CBA unload (parameter 12943 ↗ p. 122)	LM: Open CBA unload (24.32)
LM: Operation mode AUTO (parameter 12510 ↗ p. 132)	LM: Operation mode MAN (parameter 12520 ↗ p. 132)
LM: Open CBA in MAN (parameter 12957 ↗ p. 121)	LM: Open CBA in MAN (24.46)
LM: Close CBA in MAN (parameter 12958 ↗ p. 122)	LM: Close CBA in MAN (24.47)

ID	Parameter	CL	Setting range [Default]	Description
8840	Application mode LS5	1	Single LS5	Application mode  In this application mode, there is only one single LS-5 unit.
			[LS5]	Application mode  This is the application mode for multiple LS-5 units operation. In this mode a PLC can control the LS-5 units.
			L-MCB	Application mode  In this application mode, the easYgen is controlling the MCB via the LS-5. The operation mode is fixed to automatic.
			L-GGB	Application mode  In this application mode, the easYgen is controlling the GGB via the LS-5. The operation mode is fixed to automatic.

4.4.2 Breakers





4.4.2.1 Dead Bus Closure CB

General notes



NOTICE!

A dead bus closure can also be performed in the case of a mains failure. If the dead bus closure should not be performed, the corresponding parameters must be switched "Off" (parameter 8802 ↗ p. 120, 8803 ↗ p. 121 or 8804 ↗ p. 121).

ID	Parameter	CL	Setting range [Default]	Description
12950	Isolation switch is open	2	Determined by LogicsManager [[24.39 & 1] & 1]	As long as the conditions of the LogicsManager have been fulfilled, the LS-5 assumes an open isolation switch (else a closed isolation switch).
8801	Dead bus closure CBA	2	On	Dead bus closure possible according to the conditions defined by parameters 8802 ↗ p. 120, 8803 ↗ p. 121, 8804 ↗ p. 121 and 5820 ↗ p. 120.
			[Off]	No dead bus closure possible.
				Notes No access in application modes  and  .
5820	Dead bus detection max. volt.	2	0 to 30 % [10 %]	If system A/B voltage falls below this percentage of system A/B rated voltage for the time configured by parameter 8805 ↗ p. 120, a dead bus condition is detected.
8805	Dead bus closure delay time	2	0.0 to 20.0 s [5.0 s]	The system voltage must below the value configured in parameter 5820 ↗ p. 120 for at least the time defined here to detect a dead bus condition of a system.
			Notes The delay time starts as soon as the measured voltage is below the value configured in parameter 5820 ↗ p. 120. The delay time is independent of LogicsManager "Enable close CBA" (parameter 12945 ↗ p. 122).	
8802	Connect A dead to B dead	2	On	Dead bus closure of system A dead to system B dead is allowed.
			[Off]	Dead bus closure of system A dead to system B dead is not allowed.
			Notes No access in application modes  and  .	

ID	Parameter	CL	Setting range [Default]	Description
8804	Connect A alive to B dead	2	On	Dead bus closure of system A alive to system B dead is allowed.
			[Off]	Dead bus closure of system A alive to system B dead is not allowed.
			Notes No access in application modes A03 and A04 .	
8803	Connect A dead to B alive	2	On	Dead bus closure of system A dead to system B alive is allowed.
			[Off]	Dead bus closure of system A dead to system B alive is not allowed.
			Notes No access in application modes A03 and A04 .	

4.4.2.2 Configure CBA

ID	Parameter	CL	Setting range [Default]	Description
8800	CBA control	2	1 Relay	A CBA is operated and if necessary monitored. Relay [R5] (38/39/40) is used and fixed to this function.
			[2 Relays]	A CBA is operated and if necessary monitored. Relay [R5] (38/39/40) is used for the open function, relay [R6] (41/42) to close it. The opening and closing is carried out with the pulse method.
3417	CBA time pulse	2	0.10 to 0.50 s [0.50 s]	Breaker pulse duration to close the CBA.. The time of the pulse output may be adjusted to the breaker being utilized.
5715	Closing time CBA	2	40 to 300 ms [80 ms]	The inherent closing time of the CBA corresponds to the lead-time of the close command. The close command will be issued independent of the differential frequency at the entered time before the synchronous point.
3407	CBA auto unlock	2		This is used for special circuit breakers to put the CBA into a defined initial state or to enable closing at all.
			Yes	Before every close-pulse, an open-pulse is issued for defined duration (parameter 5718 ↗ p. 121). A CB close pulse is enabled only after the open pulse is issued.
			[No]	The CB close pulse is enabled without being preceded by a CB open pulse.
5718	CBA open time pulse	2	0.10 to 9.90 s [1.00 s]	This time defines the length of the CBA open time pulse, if the automatic switch unblocking CBA (parameter 3407 ↗ p. 121) is activated.
8828	Open CBA in manual	2	[Immediate]	If there is an open command in manual mode, the CBA will open immediately.
			With unl.	If there is an open command in manual mode, the CBA will open with unloading. If there is a further open command while unloading (via LM or button) the CBA opens immediately.
			Notes With the exception of application mode A01 , unloading is skipped, if no closed GCB in the relevant segments is detected. No access in application modes A03 and A04 .	
12957	Open CBA in MAN	2	Determined by LogicsManager [(0&1)&1]	Once the conditions of the LogicsManager have been fulfilled the LS-5 opens the CBA immediately or with unloading (according to parameter 8828 ↗ p. 121), if no other LS-5 with higher priority likes to do the same.
			Notes If a close or open command is active but is blocked by another device with higher priority the display shows "CBA request". Only in operation mode MANUAL. No access in application modes A03 and A04 .	

ID	Parameter	CL	Setting range [Default]	Description
12958	Close CBA in MAN	2	Determined by LogicsManager [[0&1]&1]	Once the conditions of the LogicsManager have been fulfilled the LS-5 closes the CBA, if no other LS-5 with higher priority likes to do the same. (Provided the conditions for dead bus closure or synchronization are true.)
				<p>Notes</p> <p>If a close or open command is active but is blocked by another device with higher priority the display shows "CBA request".</p> <p>Only in operation mode MANUAL.</p> <p>No access in application modes A03 and A04.</p>
12943	Open CBA unload	2	Determined by LogicsManager [[09.06& 1]&1]	Once the conditions of the LogicsManager have been fulfilled the LS-5 opens the CBA with unloading, if no other LS-5 with higher priority likes to do the same.
				<p>Notes</p> <p>If a close or open command is active but is blocked by another device with higher priority the display shows "CBA request".</p> <p>Only in operation mode AUTOMATIC.</p> <p>No access in application modes A03 and A04.</p>
12944	Open CBA immediately	2	Determined by LogicsManager [[09.04&1]&1]	Once the conditions of the LogicsManager have been fulfilled the LS-5 opens the CBA immediately.
				<p>Notes</p> <p>Only in operation mode AUTOMATIC.</p> <p>No access in application modes A03 and A04.</p>
12945	Enable close CBA	2	Determined by LogicsManager [[09.07&!08.07]&!07.05]	Once the conditions of the LogicsManager have been fulfilled the LS-5 closes the CBA, if no other LS-5 with higher priority likes to do the same. (Provided the conditions for dead bus closure or synchronization are true.)
				<p>Notes</p> <p>If a close or open command is active but is blocked by another device with higher priority the display shows "CBA request".</p> <p>Only in operation mode AUTOMATIC.</p> <p>No access in application modes A03 and A04.</p>

4.4.2.2.1 Synchronization CBA

ID	Parameter	CL	Setting range [Default]	Description
5730	Synchronization CBA	2	[Slip frequency]	The LS-5 instructs the frequency controller (e.g. easYgen) to adjust the frequency in a way, that the frequency of the variable system is marginally greater than the target. When the synchronizing conditions are reached, a close command will be issued. The slipping frequency is positive to avoid reverse power.
			Phase matching	The LS-5 instructs the frequency controller (e.g. easYgen) to adjust the phase angle of the variable system to that of the target, in view of turning the phase difference to zero.
				<p>Notes</p> <p>This parameter has no impact on Command Variables 02.28 Sync. Check Relay and 02.29 Sync. Condition.</p>

ID	Parameter	CL	Setting range [Default]	Description
5709	CBA sync. with sep. slip	2	On	The easYgen(s) take the LS-5 slip frequency separate offset (easYgen-3400XT/3500XT version 1.13 and higher, parameter 6676).
			[Off]	The easYgen(s) take the slip frequency offset (easYgen parameter 5502) of the GCBs.
			Notes This parameter is only visible if the LS-5 'Synchronization CBA' (parameter 5730 ↗ p. 122) is set to 'Slip frequency'. This parameter is only valid if the easYgen is in application mode GCB/LS5 402 and if the LS-5 'Synchronization CBA' (parameter 5730 ↗ p. 122) is set to 'Slip frequency'. The parameter 6676 is only implemented in easYgen-3400XT/3500XT version 1.13 and higher. In combination with other devices the parameter described here 5709 ↗ p. 123 has no impact.	
5711	Pos. freq. differential CBA (Positive frequency differential CBA)	2	0.00 to 0.49 Hz [+0.18 Hz]	The prerequisite for a connect command being issued for the CBA is that the differential frequency is below the configured differential frequency. This setting is always in regards of system A: <ul style="list-style-type: none"> ■ If the system B is the variable system (i.e. generator), this configuration is the maximum allowed slip frequency then generator(s) can run slower than system A. ■ If the system A is the variable system (i.e. generator), this configuration is the maximum allowed slip frequency then generator(s) can run faster than system B.
5712	Neg. freq. differential CBA (Negative frequency differential CBA)	2	-0.49 to 0.00 Hz [-0.18 Hz]	The prerequisite for a connect command being issued for the CBA is that the differential frequency is above the configured differential frequency. This setting is always in regards of system A: <ul style="list-style-type: none"> ■ If the system B is the variable system (i.e. generator), this configuration is the maximum allowed slip frequency then generator(s) can run faster than system A. ■ If the system A is the variable system (i.e. generator), this configuration is the maximum allowed slip frequency then generator(s) can run slower than system B.
5710	Voltage differential CBA	2	0.50 to 20.00 % [5.00 %]	The maximum permissible voltage differential for closing CBA is configured here. Notes If the difference between system A and system B voltage does not exceed the value configured here and the system voltages are within the operating voltage windows (parameters 5800 ↗ p. 104 / 5801 ↗ p. 104 / 5810 ↗ p. 81 / 5811 ↗ p. 81), the command: "CBA close" may be issued.

4.4.2.2.2 Phase Matching CBA



The following parameters are only valid if 'Synchronization CBA' (parameter 5730 ↗ p. 122) is configured to 'Phase matching'.

ID	Parameter	CL	Setting range [Default]	Description
5713	Max. positive phase angle CBA	2	0.0 to 60.0 ° [7.0 °]	The prerequisite for a connect command being issued for the CBA is that the leading phase angle between system B and system A is below the configured maximum permissible angle.
5714	Max. negative phase angle CBA	2	-60.0 to 0.0 ° [-7.0 °]	The prerequisite for a connect command being issued for the CBA is that the lagging phase angle between system B and system A is above the configured minimum permissible angle.
5717	Phase matching CBA dwell time	2	0.0 to 60.0 s [3.0 s]	This is the minimum time that the system A/B voltage, frequency, and phase angle must be within the configured limits before the breaker will be closed.

4.4.2.3 Synchronization Configuration



For synchronization with two systems please see additionally ↪ Chapter 9.5.1 "Synchronization Of System A and System B" on page 390.

Phase angle compensation

To determine the phase angle deviation (to be configured with the parameters listed below) do either of the following:

- When mains voltage can be connected follow the steps in ↪ "Determining the phase angle deviation (connected mains voltage)" on page 124.
- When mains voltage cannot be connected but the vector group of the transformer is known, follow the steps in ↪ "Calculating the phase angle deviation (known transformer vector group)" on page 125

Determining the phase angle deviation (connected mains voltage)

The mains voltage is connected:

1. ▶ With a phase angle deviation of 0 ° and system B not energized and system A energized, close the CBA.
 - ⇒ This will result in system A and system B being at the same voltage potential.
 - The phase angle deviation will now be displayed on the LS-5 screen (synchronization angle phi).
2. ▶ Enter the displayed value into parameter 8824 ↪ p. 125.



NOTICE!

Damaged components due to incorrect settings

- Validate the setting in every control unit with a differential voltage measurement.

Calculating the phase angle deviation (known transformer vector group)

The vector group states the phase angle deviation in multiples of 30°. From the vector group the phase angle deviation can be calculated as an angle between 0° and 360°:



To calculate the resulting value, assume the low voltage side of the transformer always lags behind the high voltage side (phase angle deviation α).

➔ Calculate the phase angle deviation as follows:

	High voltage side = System [A]	High voltage side = System [B]
$\alpha < 180^\circ$	α	$-\alpha$
$\alpha > 180^\circ$	$-360^\circ + \alpha$	$360^\circ - \alpha$

Table 26: Calculation of the phase angle deviation

ID	Parameter	CL	Setting range [Default]	Description
8825	Phase angle compensation	2		This parameter defines if the parameter 8824 ↗ p. 125 is valid or not.
			On	If a transformer is located between systems A and B and if the transformer has a vector group with a phase angle deviation, then "On" should be configured in this parameter.
			[Off]	If a transformer is not located between systems A and B or if the transformer has a vector group without a phase angle deviation, then "Off" should be configured in this parameter.
				<p>Notes</p> <p>WARNING: Ensure the following parameters are configured correctly to prevent erroneous synchronization settings. Incorrect wiring of the system cannot be compensated for with this parameter!</p> <p>Please check during initial commissioning the phase angle and the synchronization with a zero voltmeter.</p> <p>Recommendation: For safety reasons, please mark the LS-5 with a label showing the configured phase angle compensation.</p>
8824	Phase angle	2	-180 to 180° [0°]	<p>This parameter compensates phase angle deviations, which can be caused by transformers (e.g. a delta to wye transformer) located within the electrical system.</p> <p>Notes</p> <p>If a transformer is not located between systems A and B or if the transformer has a vector group without a phase angle deviation, then a phase angle deviation of 0° should be configured in this parameter.</p> <p>For information on how to determine the phase angle deviation refer to ↗ "Phase angle compensation" on page 124.</p> <p>WARNING: Ensure this parameter is configured correctly to prevent erroneous synchronization settings. Incorrect wiring of the system cannot be compensated for with this parameter!</p>
5728	Synchronization mode	2	Off	The synchronization is disabled; the frequency and voltage adaptation for synchronization is not active.
			Permissive	The unit acts as a synch check device. The unit will not issue speed or voltage bias commands to achieve synchronization, but if synchronization conditions are matched (frequency, phase, voltage and phase angle), the control will issue a breaker close command.

ID	Parameter	CL	Setting range [Default]	Description
			Check	Used for checking a synchronizer prior to commissioning. The control actively synchronizes generator(s) by issuing speed and voltage bias commands, but does not issue a breaker closure command.
			[Run]	Normal operating mode. The control actively synchronizes and issues breaker closure commands.
			Ctrl by LM	The synchronization mode is controlled by LogicsManager (12907 ↗ p. 126, 12906 ↗ p. 126 and 12908 ↗ p. 126). If none of these parameters is enabled, the synchronization is disabled. If more than one of these parameters is enabled, the following priority is valid: <ul style="list-style-type: none"> ■ 1. PERMISSIVE ■ 2. CHECK ■ 3. RUN
				Notes The device will still perform a dead busbar closure if the conditions are valid. No access in the application modes 003 and 004 .
12906	Syn. mode CHECK (Synchronization mode CHECK)	2	Determined by LogicsManager [[0&1]&1]	Once the conditions of the LogicsManager have been fulfilled the CHECK synchronization mode will be enabled.
				Notes For information on the LogicsManager and its default settings see ↗ Chapter 9.3.1 "LogicsManager Overview" on page 354.
12907	Syn. mode PERM. (Synchronization mode PERMISSIVE)	2	Determined by LogicsManager [[0&1]&1]	Once the conditions of the LogicsManager have been fulfilled the PERMISSIVE synchronization mode will be enabled.
				Notes For information on the LogicsManager and its default settings see ↗ Chapter 9.3.1 "LogicsManager Overview" on page 354.
12908	Syn. mode RUN (Synchronization mode RUN)	2	Determined by LogicsManager [[0&1]&1]	Once the conditions of the LogicsManager have been fulfilled the RUN synchronization mode will be enabled.
				Notes For information on the LogicsManager and its default settings see ↗ Chapter 9.3.1 "LogicsManager Overview" on page 354.

4.4.2.4 Configure Synchronous network

ID	Parameter	CL	Setting range [Default]	Description
8820	Connect synchronous mains	2	Yes	Closing the CBA in case of synchronous mains is possible if <ul style="list-style-type: none"> ■ System A and System B are detected as mains connected and ■ The angle is in the configuration window of parameter 8821 ↗ p. 127 for at least the time configured in parameter 8822 ↗ p. 127.
			[No]	Closing the CBA in case of synchronous mains (System A and System B are mains connected) is not allowed.
				Notes If no closed GCB in the relevant segment is detected, unloading will be canceled and the breaker will be opened immediately (even if the command "Open CBA with unloading" is active). No access in the application modes 003 and 004 .

ID	Parameter	CL	Setting range [Default]	Description
8852	Connect synchronous segments	2	Yes	Closing the CBA in case of synchronous segments is possible if <ul style="list-style-type: none"> System A and System B are detected as already connected and The angle is in the configuration window of parameter 8821 ↗ p. 127 for at least the time configured in parameter 8822 ↗ p. 127. The closing of the CBA is executed without synchronization.
			[No]	In case of synchronous segments are detected, the CBA will not be closed. Synchronization is not executed.
			Notes	No access in the application modes 403 and 404 .
8821	Max phase angle	2	0 to 20° [20°]	Maximum admissible angle between both voltage systems in case of connecting synchronous mains.
			Notes	No access in the application modes 403 and 404 .
8822	Delay time phi max	2	0 to 99 s [1 s]	Defines the time how long the phase angle (parameter 8821 ↗ p. 127) between both voltage systems needs to be below the configured maximum permissible angle before connecting synchronous mains.
			Notes	No access in the application modes 403 and 404 .

4.4.3 Configure Segment

General notes

The LS-5x1 v2 can be used in different applications. The following examples show the three basic ones.

No isolation switch

No isolation switch is installed. At the following example

- Segment no. System A is 10 (parameter 8810 ↗ p. 130)
- Segment no. System B is 11 (parameter 8811 ↗ p. 130)
- Isolation switch is set to None (parameter 8815 ↗ p. 131)

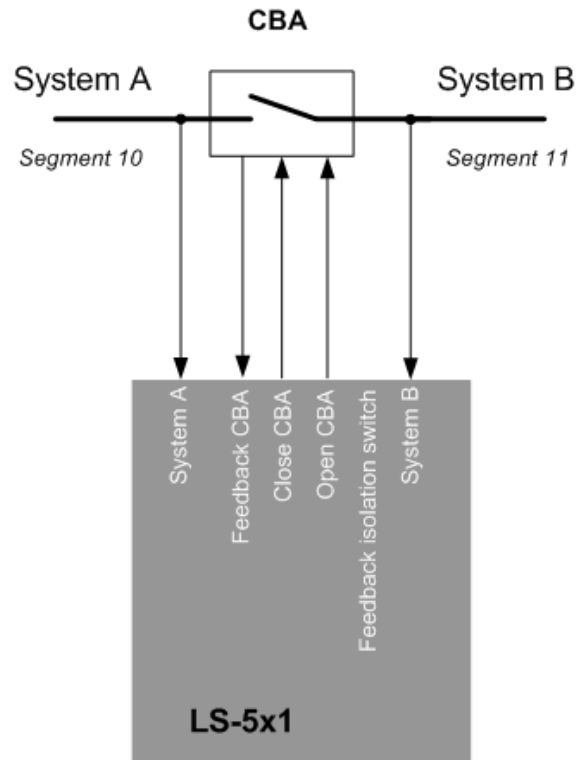

Fig. 62: LS-5x1 v2 - No isolation switch (example)

Isolation switch on System A side

The isolation switch is installed on System A side. At the following example

- Segment no. System A is 11 (parameter 8810 ↗ p. 130)
- Segment no. System B is 12 (parameter 8811 ↗ p. 130)
- Segment no. Isolation switch is 10 (parameter 8812 ↗ p. 130)
- Isolation switch is set to System A (parameter 8815 ↗ p. 131)

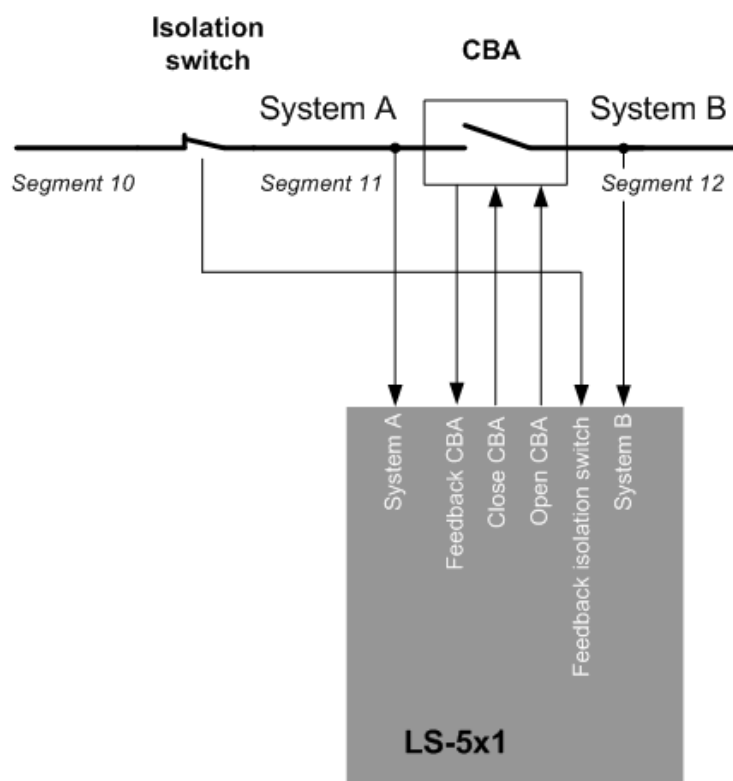

Fig. 63: LS-5x1 v2 - Isolation switch on System A side (example)

Isolation switch on System B side

The isolation switch is installed on System B side. At the following example

- Segment no. System A is 10 (parameter 8810 ↗ p. 130)
- Segment no. System B is 11 (parameter 8811 ↗ p. 130)
- Segment no. Isolation switch is 12 (parameter 8812 ↗ p. 130)
- Isolation switch is set to System B (parameter 8815 ↗ p. 131)

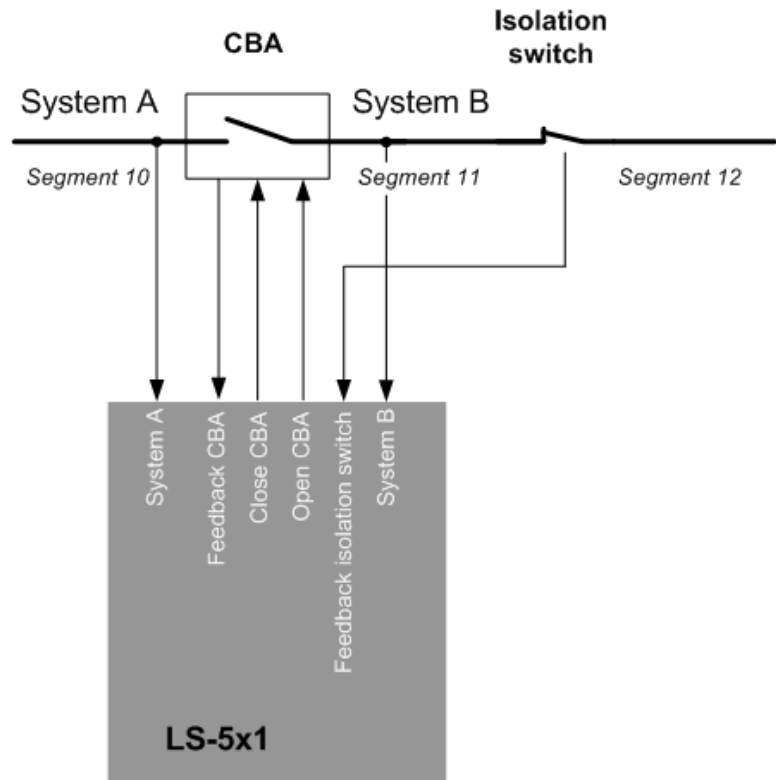

Fig. 64: LS-5x1 v2 - Isolation switch on System B side (example)

ID	Parameter	CL	Setting range [Default]	Description
8810	Segment number Sy.A	2	1 to 64 [1]	Segment number for system A.
			Notes No access in the application modes 403 and 404 .	
8811	Segment number Sy.B	2	1 to 64 [2]	Segment number for system B.
			Notes No access in the application modes 403 and 404 .	
8812	Segment number isol. switch	2	1 to 64 [1]	Segment number isolation switch (if available).
8813	Mains pow. measurem.	2	Valid	The measured power is used for mains real power control.
			[Invalid]	The measured power is not used for power control.
			Notes No access in the application modes 403 and 404 .	
8814	Mains connection	2	[None]	No system is wired to mains directly. It can not be used for mains failure detection.
			System A	System A is wired to mains directly.
			System B	System B is wired to mains directly.
			Isol. swi.	The system of the isolation switch is wired to mains.

ID	Parameter	CL	Setting range [Default]	Description
				Notes No access in the application modes A03 and A04 .
8815	Isol. switch	2	[None]	No isolation switch at system A or system B.
			System A	Isolation switch is at system A.
			System B	Isolation switch is at system B.
				Notes No access in the application modes A03 and A04 .
8816	Variable system	2		One of the systems must be defined as a variable system. A variable system is defined as a system that can change in frequency and voltage due to the easYgen control unit. In normal applications this is the frequency/voltage that is situated opposite the mains voltage of the MCB. The opposite side of the CB is therefore either constant (mains voltage) or a controlled stable (bus coupler) system.
			[System A]	Variable system is system A.
			System B	Variable system is system B.
			By LM	A LogicsManager equation determines whether variable system is system A or system B (parameter 12949 ↪ p. 131).
				Notes No access in the application modes A03 and A04 .
12949	Variab. system A (Variable system A)	2	Determined by LogicsManager	Once the conditions of the LogicsManager have been fulfilled the system A will be the variable one.
			[(0 & 1) & 1]	If the conditions of the LogicsManager have not been fulfilled the system B will be the variable one.
				This configuration is only valid, if the variable system is configured as 'By LM'. Notes No access in the application modes A03 and A04 . For information on the LogicsManager and its default settings see ↪ Chapter 9.3.1 "LogicsManager Overview" on page 354.

4.4.4 Automatic Run



Priority of operation modes

The priority of operation modes is well defined from highest to lowest priority:

- "MANUAL" is higher than
- "AUTOMATIC"

ID	Parameter	CL	Setting range [Default]	Description
8827	Startup in mode (Operating mode after applying the power supply)	2		If the controller is powered down, the unit will start in the following configured mode when it is powered up again.
			[AUTO]	The unit starts in the AUTOMATIC operating mode.
			MAN	The unit starts in the MANUAL operating mode.
			Last	The unit starts in the last operating mode the control was in prior to being de-energized.

ID	Parameter	CL	Setting range [Default]	Description
				Notes No access in the application modes 003 and 004 .
12510	Operat. mode AUTO (Activate operating mode AUTOMATIC)	2	Determined by LogicsManager [(0 & 1) & 1]	Once the conditions of the LogicsManager have been fulfilled the unit will change into operating mode AUTOMATIC. If AUTOMATIC mode is selected via the LogicsManager it is not possible to change operating modes via the front panel.
				Notes No access in the application modes 003 and 004 . For information on the LogicsManager and its default settings see Chapter 9.3.1 "LogicsManager Overview" on page 354 .
12520	Operat. mode MAN (Activate operating mode MANUAL)	2	Determined by LogicsManager [(0 & 1) & 1]	Once the conditions of the LogicsManager have been fulfilled the unit will change into operating mode MANUAL. If MANUAL mode is selected via the LogicsManager it is not possible to change operating modes via the front panel.
				Notes No access in the application modes 003 and 004 . For information on the LogicsManager and its default settings see Chapter 9.3.1 "LogicsManager Overview" on page 354 .

4.5 Inputs And Outputs

4.5.1 Discrete Inputs

General notes

Discrete inputs may be configured to normally open (N.O.) or normally closed (N.C.) states.



Fig. 65: Discrete inputs - alarm/control inputs - operation logic (state N.O.)

In the state N.O.:

- No potential is present during normal operation.
- If an alarm is issued or control operation is performed, the input is energized.



Fig. 66: Discrete inputs - alarm/control inputs - operation logic (state N.C.)

In the state N.C.:

- A potential is continuously present during normal operation
- If an alarm is issued or control operation is performed, the input is de-energized.



All reply messages from breakers are evaluated as N.C..



Alarm inputs may also be configured as control inputs and then be used as command variables in the LogicsManager.



Discrete input 8 is always used for the circuit breaker reply 'CBA is open' and cannot be configured.

Internal discrete inputs - terminal assignment

Number	Terminal	Assignment (all application modes)
[DI 01]	44	Alarm input (LogicsManager); pre-configured for lock monitoring 'Lock monitoring'
[DI 02]	45	Control input (LogicsManager); pre-configured for external acknowledge 'External Ackn.'
[DI 03]	46	Alarm input (LogicsManager); pre-configured for enable decoupling 'Enable decoupling'
[DI 04]	47	Alarm input (LogicsManager); pre-configured for immediate open CBA 'Immed. open CBA'
[DI 05]	48	Control input (LogicsManager); pre-configured for reply: isolation switch is open 'Repl. Iso. open'
[DI 06]	49	Control input (LogicsManager); pre-configured for open CBA (with unloading) 'Open CBA'
[DI 07]	50	Control input (LogicsManager); pre-configured for enable to close CBA 'En. close CBA'

Parameter IDs



The following parameters are used to configure the discrete inputs 1 through 7. The parameter IDs refer to discrete input 1.

- Refer to [Table 27](#) “Discrete inputs - parameter IDs” on page 133 for the parameter IDs of the parameters DI 2 through DI 7.

	DI 1	DI 2	DI 3	DI 4	DI 5	DI 6	DI 7
Text	1400	1410	1420	1430	1440	1450	1460
Operation	1201	1221	1241	1261	1281	1301	1321
Delay	1200	1220	1240	1260	1280	1300	1320
Alarm class	1202	1222	1242	1262	1282	1302	1322
Monitoring lockable	1203	1223	1243	1263	1283	1303	1323
Self acknowledged	1204	1224	1244	1264	1284	1304	1324

Table 27: Discrete inputs - parameter IDs



The hide and unhide of parameters of discrete inputs is handled differently by HMI and ToolKit.

ID	Parameter	CL	Setting range [Default]	Description
1400	DI {x} Text	2	user defined (4 to 16 characters) For default see Table on page 133	If the discrete input is enabled with alarm class, this text is displayed on the control unit screen. The event history will store this text message as well.
				<p>Notes</p> <p>This parameter may only be configured using ToolKit.</p> <p>If the DI is used as control input with the alarm class "Control", you may enter here its function (e.g. external acknowledgement) for a better overview within the configuration.</p>
1201	DI {x} Operation	2		The discrete inputs may be operated by an normally open (N.O.) or normally closed (N.C.) contact. The idle circuit current input can be used to monitor for a wire break. A positive or negative voltage polarity referred to the reference point of the DI may be applied.
			[N.O.]	The discrete input is analyzed as "enabled" by energizing the input (normally open).
			N.C.	The discrete input is analyzed as "enabled" by de-energizing the input (normally closed).
1200	DI {x} Delay	2	0.08 to 650.00 s DI 01: [0.20 s] DI 04: [0.20 s] Other DIs: [0.50 s]	A delay time in seconds can be assigned to each alarm or control input. The discrete input must be enabled without interruption for the delay time before the unit reacts. If the discrete input is used within the LogicsManager this delay is taken into account as well.
1202	DI {x} Alarm class	2		An alarm class may be assigned to the discrete input. The alarm class is executed when the discrete input is enabled.
			A/B	Warning alarm classes
			C/D/E/F	Shutdown alarm classes
			[Control]	Signal to issue a control command only. If "control" has been configured, there will be no entry in the event history and a function out of the LogicsManager (Chapter 9.3.1 "LogicsManager Overview" on page 354) can be assigned to the discrete input.
1203	DI {x} Monitoring lockable	2	Yes	Monitoring for fault conditions is only performed if "Lock Monitoring Status 24.40" is false.
			[No]	Monitoring for this fault condition is continuously enabled regardless of "Lock Monitoring Status 24.40".
1204	DI {x} Self acknowledge	2	Yes	The control automatically clears the alarm if the fault condition is no longer detected.

ID	Parameter	CL	Setting range [Default]	Description
			[No]	The control does not automatically reset the alarm when the fault condition is no longer detected. The alarm must be acknowledged and reset by manually pressing the appropriate buttons or by activating the LogicsManager output "External acknowledgement" (via a discrete input or via an interface).
				Notes If the DI is configured with the alarm class "Control", self acknowledgement is always active.

4.5.2 Discrete Outputs (LogicsManager)

General notes

The discrete outputs are controlled via the LogicsManager.



For information on the LogicsManager and its default settings see [Chapter 9.3.1 "Logics-Manager Overview"](#) on page 354.

Some outputs are assigned a function according to the application mode (see following table).

Relay		Application
No.	Terminal	
[R 01]	30/31	LogicsManager; pre-assigned with 'Ready for operation'
[R 02]	32/33	LogicsManager; pre-assigned with 'Centralized alarm (horn)'
[R 03]	34/35	LogicsManager; pre-assigned with 'System B not OK'
[R 04]	36/37	LogicsManager; pre-assigned with 'System A not OK'
[R 05]	38/39/40	Fixed to 'Open CBA'
[R 06]	41/42	Fixed to 'Close CBA' if CBA is controlled by 2 relays otherwise LogicsManager pre-assigned with 'All Alarm classes'

Table 28: Relay outputs - assignment



CAUTION!

Uncontrolled operation due to faulty configuration

The discrete output "Ready for operation OFF" must be wired in series with an emergency function.

- Signal this fault independently of the unit if the availability of the plant is important.



The hide and unhide of parameters of discrete outputs is handled differently by HMI and ToolKit.

ID	Parameter	CL	Setting range [Default]	Description
12580	Ready for op. Off (Ready for operation OFF)	2	Determined by LogicsManager	The "Ready for operation OFF" relay is energized by default if the power supply exceeds 8 V. Once the conditions of the LogicsManager have been fulfilled, the relay will be de-energized. This LogicsManager output may be configured with additional conditions, which may signal a PLC an "out of operation" condition by de-energizing the relay on terminals 30/31, like "shutdown alarm" or no "AUTO mode" present.
				Notes For information on the LogicsManager and its default settings see Chapter 9.3.1 "LogicsManager Overview" on page 354.
12110	Relay {x}	2	Determined by LogicsManager	Once the conditions of the LogicsManager have been fulfilled, the relay will be energized.
				Notes For information on the LogicsManager and its default settings see Chapter 9.3.1 "LogicsManager Overview" on page 354.

Parameter IDs



The parameter ID above refers to relay 2.

- Refer to [Table 29 "Discrete outputs - relay parameter IDs" on page 136](#) for the parameter IDs of the parameters for relay 3 to relay 6.

	R 1	R 2	R 3	R 4	R 5	R 6
Parameter ID	12580	12110	12310	12320	12130	12140

Table 29: Discrete outputs - relay parameter IDs

4.6 Configure Interfaces

4.6.1 General

ID	Parameter	CL	Setting range [Default]	Description
8051	ToolKit interface	2	[Serial 1]	ToolKit is working at Serial #1 interface (RS-232)
				Notes This is the preferred ToolKit connection via Service port (RJ45 connector). See Chapter 4.6.3 "RS-232 Interface" on page 144 for details.
			Serial 2	ToolKit is working at Serial #2 interface (RS-485)

4.6.2 CAN Interface

General notes



The CAN bus is a field bus and subject to various disturbances. Therefore, it cannot be guaranteed that every request will be answered. We recommend to repeat a request, which is not answered within reasonable time.

ID	Parameter	CL	Setting range [Default]	Description
9923	Comm. LS5 <-> gen. device	2		The interface, which is used for transmitting the LS-5 data and easYgen load share data is configured here.
			[CAN #1]	Use CAN interface 1.
			Off	Deactivate interface.
9921	Transfer rate fast message	2	0.10 to 0.30 s [0.10 s]	The transfer rate defines the time delay between two fast CAN messages.
				Notes In case of CAN systems with a high bus load (e.g. long distance between the units with low baud rate), a shorter transfer rate (higher time setting) helps to reduce the bus load.
9920	Comm. LS5 <-> gen. CAN-ID	2	2xx Hex / 3xx Hex / 4xx Hex / [5xx Hex]	The first digit of the CAN ID or the range (i.e. 2xx means 200 through 2FF) is configured here. The last two digits will be assigned by the control with the settings from the device number (parameter 1702 ↪ p. 73)

4.6.2.1 CAN Interface 1

COB-ID messages



Parameters 9100 ↪ p. 139 and 9101 ↪ p. 139 use synchronization and time messages that adhere to the following structure.

UNSIGN E D 32	MSB				LSB
Bits	31	30	29	28-11	10-0
11 bit ID	X	0/1	X	000000000 000000000	11 bit identifier

Bit number	Value	Meaning
31 (MSB)	X	N/A
30	0	Unit does not generate SYNC/TIME message
	1	Unit generates SYNC/TIME message
29	X	N/A
28-11	0	Always
10-0 (LSB)	X	Bits 10-0 of SYNC/TIME COB-ID

TIME synchronization message

CANopen master	COB-ID TIME	Time applied	Time transmitted
Off	Bit 30 = 0; Bit 31 = 0	No	No
	Bit 30 = 1; Bit 31 = 0	Yes	No
	Bit 30 = 0; Bit 31 = 1	No	Yes
	Bit 30 = 1; Bit 31 = 1	Yes	Yes
Default	Bit 30 = 0; Bit 31 = 0	No	No
	Bit 30 = 1; Bit 31 = 0	Yes	No
	Bit 30 = 0; Bit 31 = 1	No	Yes ¹
	Bit 30 = 1; Bit 31 = 1	Yes	Yes ¹
On	Bit 30 = 0; Bit 31 = 0	No	No
	Bit 30 = 1; Bit 31 = 0	Yes	No
	Bit 30 = 0; Bit 31 = 1	No	Yes
	Bit 30 = 1; Bit 31 = 1	Yes	Yes



¹ If CANopen master (lowest Node-ID).

ID	Parameter	CL	Setting range [Default]	Description
3156	Baudrate	2	20 / 50 / 100 / 125 / 250 / 500 / 800 / 1000 kBaud [250 kBd]	This parameter defines the used baud rate. Please note, that all participants on the CAN bus must use the same baud rate.
8950	Node-ID CAN bus 1	2	1 to 127 (dec) [33]	<p>A number that is unique to the control must be set in this parameter so that this control unit can be correctly identified on the CAN bus.</p> <p>This address number may only be used once on the CAN bus. All additional addresses are calculated based on this unique device number.</p> <p>Notes</p> <p>We recommend to configure the Node-IDs for units, which participate in load sharing, as low as possible to facilitate establishing of communication.</p> <p>No access in the application modes 003 and 004.</p>
8993	CANopen Master	2		One bus participant must take over the network management and put the other participants into "operational" mode. The LS-5 is able to perform this task.
			[Default Master]	The unit starts up in "operational" mode and sends a "Start_Remote_node" message after a short delay (the delay is the Node-ID (parameter 8950 ↗ p. 138) in seconds, i.e. if the Node-ID is configured to 2, the message will be sent after 2 seconds). If more than one easYgen / LS-5 is configured to Default Master, the unit with the lower Node-ID will take over control. Therefore, the CAN bus devices, which are intended to act as Default Master should be assigned a low Node-ID. No other device on the CAN bus (except the easYgens / LS-5s) may operate as Master).
			On	The unit is the CANopen Master and automatically changes into operational mode and transmits data.
			Off	The unit is a CANopen Slave. An external Master must change into operational mode.

ID	Parameter	CL	Setting range [Default]	Description
				<p>Notes</p> <p>If this parameter is configured to "Off", the Master controller (for example a PLC) must send a "Start_Remote_node" message to initiate the load share message transmission of the easYgen.</p> <p>If no "Start_Remote_node" message would be sent, the complete system would not be operational.</p>
9120	Producer heartbeat time	2	0 to 65500 ms [2000 ms]	<p>Independent from the CANopen Master configuration, the unit transmits a heartbeat message with this configured heartbeat cycle time.</p> <p>If the producer heartbeat time is equal 0, the heartbeat will only be sent as response to a remote frame request. The time configured here will be rounded up to the next 20 ms step.</p>
9100	COB-ID SYNC Message	2	1 to FFFFFFFF hex [80 hex]	<p>This parameter defines whether the unit generates the SYNC message or not.</p> <p>The message complies with CANopen specification: object 1005; subindex 0 defines the COB-ID of the synchronization object (SYNC).</p> <p>Notes</p> <p>The structure of this object is shown in ☞ "COB-ID messages" on page 137.</p>
8940	Producer SYNC Message time	2	0 to 65000 ms [20 ms]	<p>This is the cycle time of the SYNC message. If the unit is configured for this function (parameter 9100 ☞ p. 139) it will send the SYNC message with this interval. The time configured here will be rounded up to the next 10 ms step.</p>
9101	COB-ID TIME Message	2	1 to FFFFFFFF hex [100 hex]	<p>This parameter defines whether the unit generates the TIME message or not.</p> <p>Complies with CANopen specification: object 1012, subindex 0; defines the COB-ID of the time object (TIME).</p> <p>Notes</p> <p>The structure of this object is shown in ☞ "COB-ID messages" on page 137.</p>

4.6.2.2 Additional Server SDOs (Service Data Objects)

General notes



The CAN bus is a field bus and subject to various disturbances. Therefore, it cannot be guaranteed that every request will be answered. We recommend to repeat a request, which is not answered within reasonable time.

The first Node-ID is the standard Node-ID of CAN interface 1 (parameter 8950 [☞ p. 138](#)).

ID	Parameter	CL	Setting range [Default]	Description
33040	2. Node-ID	2	0 to 127 (dec) [0]	<p>In a multi-master application, each Master needs its own identifier (Node-ID) from the unit. in order to send remote signals (i.e. remote start, stop, or acknowledge) to the unit.</p> <p>The additional SDO channel will be made available by configuring this Node-ID to a value different than zero. This is the additional CAN ID for the PLC.</p>
33041	3. Node-ID	2	0 to 127 (dec) [0]	<p>In a multi-master application, each Master needs its own identifier (Node-ID) from the unit. in order to send remote signals (i.e. remote start, stop, or acknowledge) to the unit.</p> <p>The additional SDO channel will be made available by configuring this Node-ID to a value different than zero. This is the additional CAN ID for the PLC.</p>

Configuration

Configure Interfaces > CAN Interface > Receive PDO {x} (Process D...

ID	Parameter	CL	Setting range [Default]	Description
33042	4. Node-ID	2	0 to 127 (dec) [0]	In a multi-master application, each Master needs its own identifier (Node-ID) from the unit. in order to send remote signals (i.e. remote start, stop, or acknowledge) to the unit. The additional SDO channel will be made available by configuring this Node-ID to a value different than zero. This is the additional CAN ID for the PLC.
33043	5. Node-ID	2	0 to 127 (dec) [0]	In a multi-master application, each Master needs its own identifier (Node-ID) from the unit. in order to send remote signals (i.e. remote start, stop, or acknowledge) to the unit. The additional SDO channel will be made available by configuring this Node-ID to a value different than zero. This is the additional CAN ID for the PLC.

4.6.2.3 Receive PDO {x} (Process Data Object)

General notes

There are two Receive PDOs.

RPDO mapping is carried out as shown in (Fig. 67).

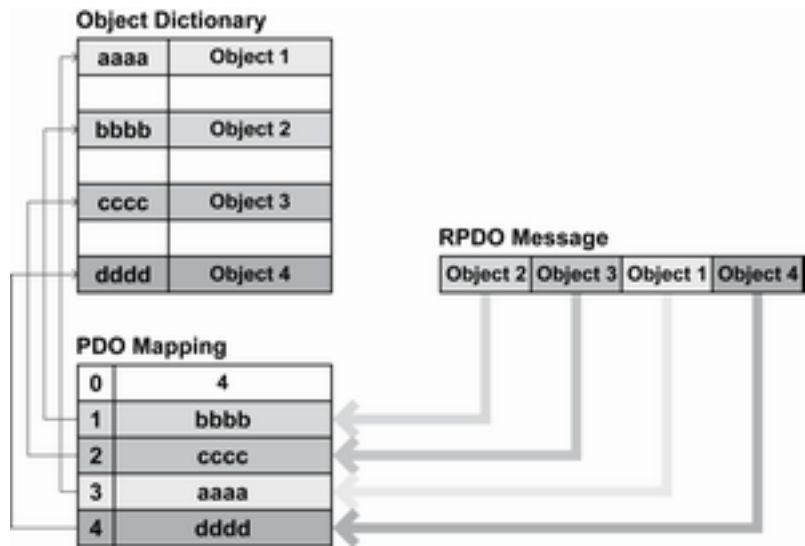

Fig. 67: RPDO mapping principle

COB-ID parameters



Parameter 9300 ↪ p. 141 , 9310 ↪ p. 141 uses communication parameters that adhere to the following structure.

UNSIGNED 32	MSB				LSB
Bits	31	30	29	28-11	10-0
11 bit ID	0/1	X	X	00000000 00000000	11 bit identifier

Bit number	Value	Meaning
31 (MSB)	0	PDO exists / is valid
	1	PDO does not exist / is not valid
30	X	N/A
29	X	N/A
28-11	0	Always
10-0 (LSB)	X	Bits 10-0 of COB-ID



PDO valid / not valid allows to select, which PDOs are used in the operational state.

ID	Parameter	CL	Setting range [Default]	Description
9300 9310	COB-ID	2	1 to FFFFFFFF hex [80000000 hex]	This parameter contains the communication parameters for the PDOs, the device is able to receive. Complies with CANopen specification: object 1400 (for RPDO 1, 1401 for RPDO 2 and 1402 for RPDO 3), subindex 1.
Notes			The structure of this object is shown in ☞ “COB-ID parameters” on page 140. Do not configure an RPDO or TPDO with a COB-ID higher than 580 (hex) or lower than 180 (hex). These IDs are reserved for internal purposes.	
9121 9122	Event-timer	2	0 to 65,500 ms [2,000 ms]	This parameter configures the time, from which this PDO is marked as "not existing". The time configured here will be rounded up to the next 5 ms step. Received messages are processed by the control unit every 20 ms. Messages, which are sent faster, will be discarded. We recommend to configure ten times the cycle time of the received data here.
Notes			Complies with CANopen specification: object 1400 (for RPDO 1, 1401 for RPDO 2 and 1402 for RPDO 3), subindex 5	

4.6.2.4 Transmit PDO {x} (Process Data Object)

General notes

There are three Transmit PDOs.

TPDO mapping is carried out as shown in (Fig. 68).

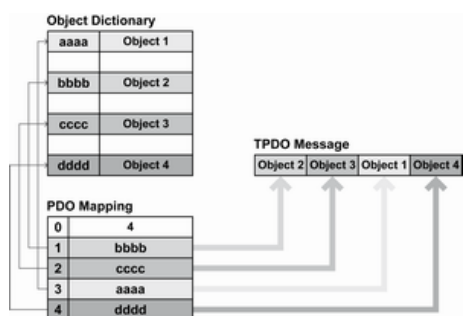

Fig. 68: TPDO mapping



CANopen allows to send 8 byte of data with each Transmit PDO. These may be defined separately if no pre-defined data protocol is used.

All data protocol parameters with a parameter ID may be sent as an object with a CANopen Transmit PDO.

The data length of the value is defined by the number of used bytes. This will be taken from the data byte column (see [☞ Chapter 9.2 “Data Protocols” on page 273.](#))

The object ID is identical with the parameter ID when configuring via front panel or ToolKit.

Configuration

Configure Interfaces > CAN Interface > Transmit PDO {x} (Process ...

COB-ID parameters



Parameters 9600 ↗ p. 143 / 9610 ↗ p. 143 / 9620 ↗ p. 143 use communication parameters that adhere to the following structure.

UNSIGN D 32	MSB				LSB
Bits	31	30	29	28-11	10-0
11 bit ID	0/1	X	X	000000000 000000000	11 bit identifier

Bit number	Value	Meaning
31 (MSB)	0	PDO exists / is valid
	1	PDO does not exist / is not valid
30	X	N/A
29	X	N/A
28-11	0	Always
10-0 (LSB)	X	Bits 10-0 of COB-ID



PDO valid / not valid allows to select, which PDOs are used in the operational state.

Transmission types



Parameters 9602 ↗ p. 143 / 9612 ↗ p. 143 / 9622 ↗ p. 143 are used to select one of the following transmission types.

Transmission type	PDO transmission				
	Cyclic	Acyclic	Synchronous	Asynchronous	RTR only
0	Will not be sent				
1-240	X		X		
241-251	Will not be sent				
252	Will not be sent				
253	Will not be sent				
254				X	
255				X	



A value between 1 and 240 means that the PDO is transferred synchronously and cyclically. The transmission type indicating the number of SYNC, which are necessary to trigger PDO transmissions.

Receive PDOs are always triggered by the following SYNC upon reception of data independent of the transmission types 0 to 240. For TPDOs, transmission type 254 and 255 means, the application event is the event timer.

ID	Parameter	CL	Setting range [Default]	Description
9600 9610 9620	COB-ID	2	1 to FFFFFFFF hex	This parameter contains the communication parameters for the PDOs the unit is able to transmit. The unit transmits data (i.e. visualization data) on the CAN ID configured here.
[80000000 hex]			Complies with CANopen specification: object 1800 for (TPDO 1, 1801 for TPDO 2 and 1802 for TPDO 3), subindex 1.	
				Notes The structure of this object is shown in “COB-ID parameters” on page 142 Do not configure an RPDO or TPDO with a COB-ID higher than 580 (hex) or lower than 180 (hex). These IDs are reserved for internal purposes.
9602 9612 9622	Transmission type	2	0 to 255	This parameter contains the communication parameters for the PDOs the unit is able to transmit. It defines whether the unit broadcasts all data automatically (value 254 or 255) or only upon request with the configured address of the COB-ID SYNC message (parameter 9100 p. 139).
[255]			Notes Complies with CANopen specification: object 1800 (for TPDO 1, 1801 for TPDO 2 and 1802 for TPDO 3), subindex 2. The description of the transmission type is shown in “Transmission types” on page 142 .	
9604 9614 9624	Event timer	2	0 to 65500 ms	This parameter contains the communication parameters for the PDOs the unit is able to transmit. The broadcast cycle for the transmitted data is configured here. The time configured here will be rounded up to the next 5 ms step.
[20 ms]			Notes Complies with CANopen specification: object 1800 (for TPDO 1, 1801 for TPDO 2 and 1802 for TPDO 3), subindex 5	
8962 8963 8964	Selected Data Protocol	2	0 to 65535	A data protocol may be selected by entering the data protocol ID here. If 0 is configured here, the message assembled by the mapping parameters is used. If an unknown data protocol ID is configured here, a failure is indicated by the CAN status bits.
8962: [5301]			Possible data protocol IDs are:	
8963: [0] 8964: [0]			5301 5302	Data telegrams
9609 9619 9629	Number of Mapped Objects	2	0 to 4	This parameter contains the mapping for the PDOs the unit is able to transmit. This number is also the number of the application variables, which shall be transmitted with the corresponding PDO.
[0]			Notes Complies with CANopen specification: object 1A00 (for TPDO 1, 1A01 for TPDO 2 and 1A02 for TPDO 3), subindex 0	
9605 9615 9625	1. Mapped Object	2	0 to 65535	This parameter contains the information about the mapped application variables. These entries describe the PDO contents by their index. The sub-index is always 1. The length is determined automatically.
			[0]	

ID	Parameter	CL	Setting range [Default]	Description
				Notes Complies with CANopen specification: object 1A00 (for TPDO 1, 1A01 for TPDO 2 and 1A02 for TPDO 3), subindex 1
9606 9616 9626	2. Mapped Object	2	0 to 65535 [0]	This parameter contains the information about the mapped application variables. These entries describe the PDO contents by their index. The sub-index is always 1. The length is determined automatically.
				Notes Complies with CANopen specification: object 1A00 (for TPDO 1, 1A01 for TPDO 2 and 1A02 for TPDO 3), subindex 2
9607 9617 9627	3. Mapped Object	2	0 to 65535 [0]	This parameter contains the information about the mapped application variables. These entries describe the PDO contents by their index. The sub-index is always 1. The length is determined automatically.
				Notes Complies with CANopen specification: object 1A00 (for TPDO 1, 1A01 for TPDO 2 and 1A02 for TPDO 3), subindex 3
9608 9618 9628	4. Mapped Object	2	0 to 65535 [0]	This parameter contains the information about the mapped application variables. These entries describe the PDO contents by their index. The sub-index is always 1. The length is determined automatically.
				Notes Complies with CANopen specification: object 1A00 (for TPDO 1, 1A01 for TPDO 2 and 1A02 for TPDO 3), subindex 4

4.6.3 RS-232 Interface

ID	Parameter	CL	Setting range [Default]	Description
3163	Baudrate	2	2.4 / 4.8 / 9.6 / 14.4 / [19.2] / 38.4 / 56 / 115 kBaud	This parameter defines the baud rate for communications. Please note, that all participants on the bus must use the same baud rate.
3161	Parity	2	[No] / Even / Odd	The used parity of the interface is set here.
3162	Stop bits	2	[One] / Two	The number of stop bits is set here.
3185	ModBus Slave ID	2	0 to 255 [33]	The Modbus device address, which is used to identify the device via Modbus, is entered here. If "0" is configured here, the Modbus is disabled.
3186	Reply delay time	2	0.00 to 1.00 s [0.00 s]	This is the minimum delay time between a request from the Modbus master and the sent response of the slave. This time is also required if an external interface converter to RS-485 is used for example.

4.6.4 RS-485 Interface

ID	Parameter	CL	Setting range [Default]	Description
3170	Baudrate	2	2.4 / 4.8 / 9.6 / 14.4 / [19.2] / 38.4 / 56 / 115 kBaud	This parameter defines the baud rate for communications. Please note, that all participants on the bus must use the same baud rate.
3171	Parity	2	[No] / Even / Odd	The used parity of the interface is set here.

ID	Parameter	CL	Setting range [Default]	Description
3172	Stop bits	2	[One] / Two	The number of stop bits is set here.
3188	ModBus Slave ID	2	0 to 255 [33]	The Modbus device address, which is used to identify the device via Modbus, is entered here. If "0" is configured here, the Modbus is disabled.
3189	Reply delay time	2	0.00 to 2.55 s [0.00 s]	This is the minimum delay time between a request from the Modbus master and the sent response of the slave. This time is required in half-duplex mode.

4.6.5 Modbus Protocol (5300 Multiple)

ID	Parameter	CL	Setting range [Default]	Description
3181	Power [W] exponent 10^x	2	2 to 5 [3]	This setting adjusts the format of the 16 bit power values in the data telegram.
			Notes	For an example refer to ↗ "Power measurement example" on page 145.
3182	Voltage [V] exponent 10^x	2	-1 to 2 [0]	This setting adjusts the format of the 16 bit voltage values in the data telegram.
			Notes	For an example refer to ↗ "Voltage measurement example" on page 146.
3183	Current [A] exponent 10^x	2	-1 to 0 [0]	This setting adjusts the format of the 16 bit current values in the data telegram.
			Notes	For an example refer to ↗ "Current measurement example" on page 146.

Power measurement example

Refer to parameter 3181 ↗ p. 145.

- The measurement range is 0...250 kW
- Momentarily measurement value = 198.5 kW (198.500 W)

Setting	Meaning	Calculation	Transfer value (16Bit, max. 32767)	Possible display format
2	10 ²	198500 W / 10 ²	1985	198.5 kW
3	10 ³	198500 W / 10 ³	198	198 kW
4	10 ⁴	198500 W / 10 ⁴	9	N/A
5	10 ⁵	198500 W / 10 ⁵	1	N/A

Voltage measurement example



Refer to parameter 3182 ↗ p. 145.

- The measurement range is 0...480 V
- Momentarily measurement value = 477.8 V

Setting	Meaning	Calculation	Transfer value (16Bit, max. 32767)	Possible display format
-1	10 ⁻¹	477.8 V / 10 ⁻¹	4778	47.8 V
0	10 ⁰	477.8 V / 10 ⁰	477	477 V
1	10 ¹	477.8 V / 10 ¹	47	N/A
2	10 ²	477.8 V / 10 ²	4	N/A

Current measurement example



Refer to parameter 3183 ↗ p. 145.

- The measurement range is 0...500 A
- Momentarily measurement value = 345.4 A

Setting	Meaning	Calculation	Transfer value (16Bit, max. 32767)	Possible display format
-1	10 ⁻¹	345.4 A / 10 ⁻¹	3454	345.4 A
0	10 ⁰	345.4 A / 10 ⁰	345	345 A

4.7 Configure LogicsManager

Logical symbols

The LS-5 LogicsManager screens show logical symbols according to the IEC standard.



Refer to ↗ Chapter 9.3.2 "Logical Symbols" on page 356 for a table of symbols according to the different standards.

ID	Parameter	CL	Setting range [Default]	Description
{yyyyy}	Flag {x}	2	Determined by LogicsManager [(0 & 1) & 1]	The flags may be used as auxiliary flags for complex combinations by using the logical output of these flags as command variable for other logical outputs. For the corresponding IDs refer to Table 33 “LED flag parameter IDs” on page 148.
{yyyyy}	Flag {x} LS5	2	Determined by LogicsManager [(0 & 1) & 1]	The flags may be used as auxiliary flags for complex combinations by using the logical output of these flags as command variable for other logical outputs. For the corresponding IDs refer to Table 33 “LED flag parameter IDs” on page 148.
{yyyyy}	LED {x}	2	Determined by LogicsManager	LS-51x: The flags are used to control the LED states. The default values are defined on the provided paper strip. LS-52x: The flags may be used as auxiliary flags for complex combinations by using the logical output of these flags as command variable for other logical outputs. For the corresponding IDs refer to Table 33 “LED flag parameter IDs” on page 148.

Internal flags

Internal flags within the LogicsManager logical outputs may be programmed and used for multiple functions.



The flag parameters are listed as one entry in the parameter table below. For the parameter IDs of each individual flag parameter refer to [Table 30 “Flag parameter IDs \(1 to 8\)” on page 147.](#)

Flag {x}	Flag 1	Flag 2	Flag 3	Flag 4	Flag 5	Flag 6	Flag 7	Flag 8
Parameter ID {yyyyy}	12230	12240	12250	12260	12270	12280	12290	12300

Table 30: Flag parameter IDs (1 to 8)

Flag {x}	Flag 9	Flag 10	Flag 11	Flag 12	Flag 13	Flag 14	Flag 15	Flag 16
Parameter ID {yyyyy}	12910	12911	12912	12913	12914	12915	12916	12917

Table 31: Flag parameter IDs (9 to 16)



For conditions and explanation of programming please refer to [Chapter 9.3.1 “LogicsManager Overview” on page 354.](#)

LS-5 flags

Each LS-5 has five special flags (“Flag 1 LS5” to “Flag 5 LS5”) which can be defined via LogicsManager. They are transmitted via CAN bus. These flags (26.01 to 27.80) are received by the other LS-5 and easYgen devices and can be used as inputs for the LogicsManager



The command parameters are listed as one entry in the parameter table below. For the parameter IDs of each individual command parameter refer to [Table 32 “LS-5 flag parameter IDs”](#) on page 148

Flag {x} LS-5	Flag 1 LS-5	Flag 2 LS-5	Flag 3 LS-5	Flag 4 LS-5	Flag 5 LS-5
Parameter ID {yyyyy}	12952	12953	12954	12955	12956

Table 32: LS-5 flag parameter IDs



For conditions and explanation of programming please refer to [Chapter 9.3.1 “LogicsManager Overview”](#) on page 354.

LEDs

Each LS-51x (metal housing variant) has eight LED flags (“LED 1” to “LED 8”) which can be defined via LogicsManager.

LED (internal) flags (24.51 to 24.58) within the LogicsManager logical outputs may be programmed and used for multiple functions.



The LED configuration is used in the LS-51x to control the LEDs. In the LS-52x version (with display but without LEDs) the LED flags can be used as additional internal flags.

The LED {x} LogicsManagers are available via HMI and ToolKit even if the menu tree (location) is different.



The flag parameters are listed as one entry in the parameter table below. For the parameter IDs of each individual flag parameter refer to [Table 33 “LED flag parameter IDs”](#) on page 148.



For conditions and explanation of programming please refer to [Chapter 9.3.1 “LogicsManager Overview”](#) on page 354.

LED {x}	LED 1	LED 2	LED 3	LED 4	LED 5	LED 6	LED 7	LED 8
Parameter ID {yyyyy}	12962	12963	12964	12965	12966	12967	12968	12969

Table 33: LED flag parameter IDs

LogicsManager Timers: Set timers

Utilizing the LogicsManager it is possible to establish specific times of the day, days, hours, minutes or seconds that functions can be enabled.

Logic command variable	Function
11.01	Timer 1
11.02	Timer 2
11.03	Active weekday
11.04	Active day
11.05	Active hour
11.06	Active minute
11.07	Active second



Daily time setpoints - Timer 1/2

Utilizing the LogicsManager it is possible to establish specific times of the day that functions (i.e. generator exerciser) can be enabled.

The two daily time setpoints are activated each day at the configured time and last until the end of the day. Using the LogicsManager these setpoints may be configured individually or combined to create a time range.



Active time setpoints

Utilizing the LogicsManager it is possible to establish specific days (or hours, minutes, seconds) that functions (i.e. generator exerciser) can be enabled. The active switching point is activated only on a specified day (or hour, minute, second).

The setpoints may be configured individually or combined via the LogicsManager. You may configure monthly, daily, hourly, minutely, or even secondly time setpoints depending on how you combine the setpoints in the LogicsManager.



Weekly time setpoint

Utilizing the LogicsManager it is possible to establish specific days of the week that functions (i.e. generator exerciser) can be enabled.

The weekly time setpoint is enabled during the indicated day from 0:00:00 hours to 23:59:59 hours.

Daily time setpoints - Timer 1/2

ID	Parameter	CL	Setting range [Default]	Description
1652 1657	Timer {x}: Hour	2	0 to 23 h 1652: [8 h] 1657: [17 h]	Enter the hour of the daily time setpoint here. Example <ul style="list-style-type: none"> ■ 0 = 0th hour of the day (midnight). ■ 23 = 23rd hour of the day (11pm).
1651 1656	Timer {x}: Minute	2	0 to 59 min [0 min]	Enter the minute of the daily time setpoint here. Example <ul style="list-style-type: none"> ■ 0 = 0th minute of the hour. ■ 59 = 59th minute of the hour.
1650 1655	Timer {x}: Second	2	0 to 59 s [0 s]	Enter the second of the daily time setpoint here. Example <ul style="list-style-type: none"> ■ 0 = 0th second of the minute. ■ 59 = 59th second of the minute.

Active time setpoints

ID	Parameter	CL	Setting range [Default]	Description
1663	Active day	2	Day 1 to 31 [1]	Enter the day of the active switch point here. The active time setpoint is enabled during the indicated day from 0:00:00 hours to 23:59:59 hours. Example <ul style="list-style-type: none"> ■ 01 = 1st day of the month. ■ 31 = 31st day of the month.
1662	Active hour	2	0 to 23 h [12 h]	Enter the hour of the active switch point here. The active time setpoint is enabled every day during the indicated hour from minute 0 to minute 59. Example <ul style="list-style-type: none"> ■ 0 = 0th hour of the day. ■ 23 = 23rd hour of the day.
1661	Active minute	2	0 to 59 min [0 min]	Enter the minute of the active switch point here. The active time setpoint is enabled every hour during the indicated minute from second 0 to second 59. Example <ul style="list-style-type: none"> ■ 0 = 0th minute of the hour. ■ 59 = 59th minute of the hour.
1660	Active second	2	0 to 59 s [0 s]	Enter the second of the active switch point here. The active time setpoint is enabled every minute during the indicated second. Example <ul style="list-style-type: none"> ■ 0 = 0th second of the minute. ■ 59 = 59th second of the minute.

Weekly time setpoint - active week days

ID	Parameter	CL	Setting range [Default]	Description
				Please select each of the active weekdays.
1670	Monday active	2	[Yes]	The switch point is enabled every Monday.
			No	The switch point is disabled every Monday.
1671	Tuesday active	2	[Yes]	The switch point is enabled every Tuesday.
			No	The switch point is disabled every Tuesday.
1672	Wednesday active	2	[Yes]	The switch point is enabled every Wednesday.
			No	The switch point is disabled every Wednesday.
1673	Thursday active	2	[Yes]	The switch point is enabled every Thursday.
			No	The switch point is disabled every Thursday.
1674	Friday active	2	[Yes]	The switch point is enabled every Friday.
			No	The switch point is disabled every Friday.
1675	Saturday active	2	Yes	The switch point is enabled every Saturday.
			[No]	The switch point is disabled every Saturday.
1676	Sunday active	2	Yes	The switch point is enabled every Sunday.
			[No]	The switch point is disabled every Sunday.

4.8 Configure Counters

ID	Parameter	CL	Setting range [Default]	Description
2515	Counter value preset	2	0 to 999,999.99 [0]	<p>This value is utilized to set the following counters:</p> <ul style="list-style-type: none"> ■ MWh counter ■ Mvarh counter <p>The number entered into this parameter is the number that will be set to the parameters listed below when they are enabled.</p>
2510	Set SyA. active energy [0.00 MWh]	2	Yes	The current value of this counter is overwritten with the value configured in "Counter value preset" (parameter 2515 ↗ p. 151). After the counter has been (re)set, this parameter changes back to "No" automatically.
			[No]	The value of this counter is not changed.
				<p>Example</p> <ul style="list-style-type: none"> ■ The counter value preset (parameter 2515 ↗ p. 151) is configured to "3456". ■ If this parameter is set to "Yes", the "System A active power" counter will be set to 34.56 MWh.
2512	Set SyA. - active energy [0.00 MWh]	2	Yes	The current value of this counter is overwritten with the value configured in "Counter value preset" (parameter 2515 ↗ p. 151). After the counter has been (re)set, this parameter changes back to "No" automatically.
			[No]	The value of this counter is not changed.

Configuration

Configure Counters

ID	Parameter	CL	Setting range [Default]	Description
				<p>Example</p> <ul style="list-style-type: none"> ■ The counter value preset (parameter 2515 ↗ p. 151) is configured to "3456". ■ If this parameter is set to "Yes", the "System A active power" counter will be set to 34.56 MWh.
2511	Set SyA. reactive energy [0.00 Mvarh]	2	Yes	The current value of this counter is overwritten with the value configured in "Counter value preset" (parameter 2515 ↗ p. 151). After the counter has been (re)set, this parameter changes back to "No" automatically.
			[No]	The value of this counter is not changed.
				<p>Example</p> <ul style="list-style-type: none"> ■ The counter value preset (parameter 2515 ↗ p. 151) is configured to "3456". ■ If this parameter is set to "Yes", the "System A reactive power" counter will be set to 34.56 Mvarh.
2513	Set SyA. -reactive energy [0.00 Mvarh]	2	Yes	The current value of this counter is overwritten with the value configured in "Counter value preset" (parameter 2515 ↗ p. 151). After the counter has been (re)set, this parameter changes back to "No" automatically.
			[No]	The value of this counter is not changed.
				<p>Example</p> <ul style="list-style-type: none"> ■ The counter value preset (parameter 2515 ↗ p. 151) is configured to "3456". ■ If this parameter is set to "Yes", the "System A -reactive power" counter will be set to 34.56 Mvarh.
2541	Counter value preset	2	0 to 65535 [0]	This parameter defines the number of times the control unit registers a CBA closure. The number entered here will overwrite the current displayed value after confirming with parameter 2542 ↗ p. 152.
2542	CBA set number of closures	2	Yes	The current value of the CBA close counter is overwritten with the value configured in "Counter value preset". After the counter has been (re)set, this parameter changes back to "No" automatically.
			[No]	The value of this counter is not changed.

5 Operation

The LS-5 can be operated, monitored and configured using the following access methods:

- Access via the front panel (LS-52x only)
 - ↳ Chapter 5.2 “Front Panel Access” on page 167
- External access with a PC using the ToolKit configuration software.
 - ↳ Chapter 5.1 “Access Via PC (ToolKit)” on page 153
- External command access using Modbus/CANopen protocols
 - ↳ Chapter 7 “Interfaces And Protocols” on page 257

5.1 Access Via PC (ToolKit)

Version



Woodward's ToolKit software is required to access the unit via PC

- Required version: 5.4 or higher
- Please use the latest available version!
- For information on how to obtain the latest version see ↳ “Load from the website” on page 154.

5.1.1 Install ToolKit

Load from CD



Fig. 69: Product CD - HTML menu



Fig. 70: HTML menu section 'Software'

1. ▶ Insert the product CD (as supplied with the unit) in the CD-ROM drive of your computer.
 - ⇒ The HTML menu is opened automatically in a browser.



The 'autostart' function of your operating system needs to be activated.

Alternately open the document "start.html" in the root directory of the CD in a browser.

2. ▶ Go to section “Software” and follow the instructions described there.

Load from the website



The latest version of the ToolKit software (5.4.0 or higher) can be obtained from our website.

The latest version of Microsoft .NET Framework (4.6.1 or higher) can be obtained from Microsoft website.

To get the software from the website:

1. ➤ Go to <http://www.woodward.com/software>
2. ➤ Search the ToolKit software by typing 'ToolKit' at 'Enter Search Term' and click the "Search" button.
3. ➤ Click "More Info" to get further information about ToolKit.
4. ➤ Choose the preferred software version and click "Download".
5. ➤ Login with your e-mail address or register first.
 - ⇒ The download will start immediately.

Minimum system requirements

- Microsoft Windows® 10, 8.1, 7, Vista (32- & 64-bit)
- Microsoft .NET Framework Ver. 4.5.1
- 1 GHz or faster x86 or x64 processor
- 1 GB of RAM
- Screen
 - Resolution: 1024 by 768 pixels
 - Text size: 96 dpi
- Appropriate communication hardware (e.g. Serial Port, CAN adapter, Ethernet)



Microsoft .NET Framework must be installed on your computer to be able to install ToolKit.

- *If not already installed, Microsoft .NET Framework will be installed automatically (internet connection required).*
- *Alternatively use the .NET Framework installer found on the Product CD.*

Installation

To install ToolKit:

- Run the self-extracting installation package and follow the on-screen steps to install.

5.1.2 Install ToolKit Configuration Files

Load from CD



Fig. 71: Product CD - HTML menu



Fig. 72: HTML menu section 'Software'

Load from the website

1. ➤ Insert the product CD (as supplied with the unit) in the CD-ROM drive of your computer.
 - ⇒ The HTML menu is opened automatically in a browser.



The 'autostart' function of your operating system needs to be activated.

Alternately open the document "start.html" in the root directory of the CD in a browser.

Details of your current product CD menu may differ because of updates.

2. ➤ Go to section "Configuration Files" and follow the instructions described there.



The latest version of the ToolKit software can be obtained from our website.

To get the software from the website:

1. ➤ Go to <http://www.woodward.com/software/configfiles>
2. ➤ Insert the part number (P/N) and revision of your device into the corresponding fields.
3. ➤ Select "ToolKit" in the "application type" list.
4. ➤ Click "Search".
5. ➤ Download the file displayed in the search result.
 - ⇒ The file is a *.msi file which must be installed.

Operation

Access Via PC (ToolKit) > Install ToolKit Configura...

ToolKit files

*.WTOOL	
File name composition:	[P/N1] ¹ -[Revision]_[Language ID]_[P/N2] ² -[Revision]_[# of visualized gens].WTOOL
Example file name:	8440-1234-NEW_US_5418-1234-NEW.WTOOL
File content:	Display screens and pages for online configuration, which are associated with the respective *.SID file.

*.SID	
File name composition:	[P/N2] ² -[Revision].SID
Example file name:	5418-1234-NEW.SID
File content:	All display and configuration parameters available in ToolKit.

*.WSET	
File name composition:	[user defined].WSET
Example file name:	device_settings.WSET
File content:	Default settings of the ToolKit configuration parameters provided by the SID file or user-defined settings read from the unit.

- ¹ P/N1 = Part number of the unit
- ² P/N2 = Part number of the software in the unit

5.1.3 Configure ToolKit

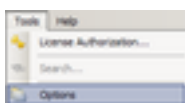

Fig. 73: Tools menu

To change ToolKit settings:

1. Select "Tools → Options".

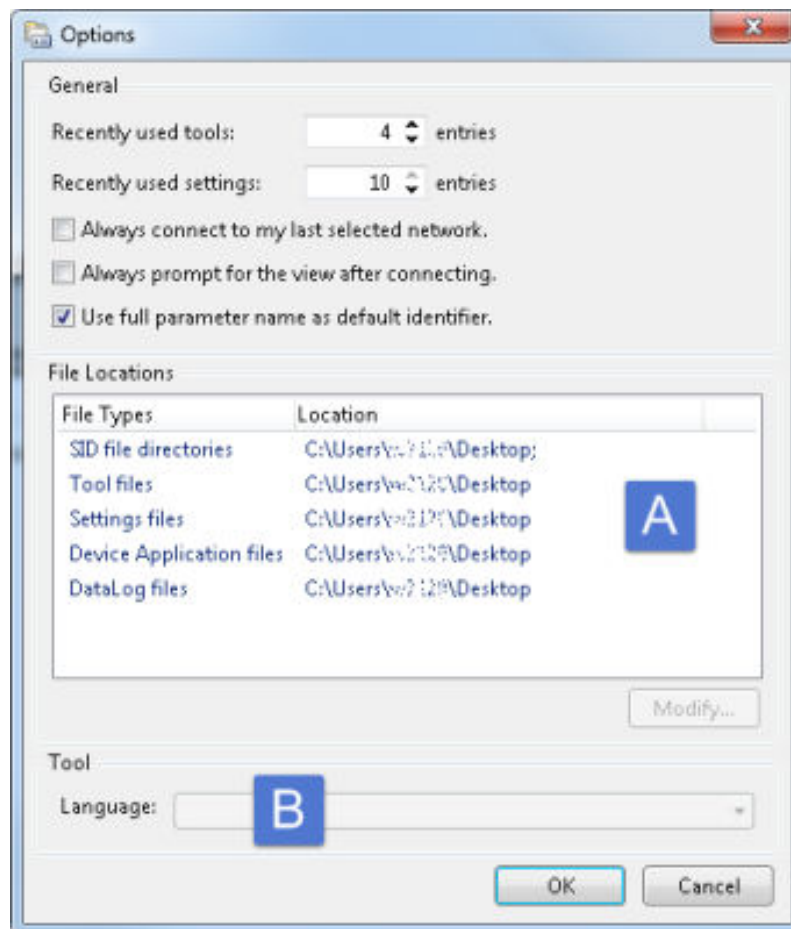

Fig. 74: ToolKit Options window

- A File locations
 - B Language setting for tools
 - ⇒ The "Options" windows is displayed.
2. Adjust settings as required.

i For more information on the individual settings refer to the ToolKit help.

⇒ Changes take effect after clicking "OK".

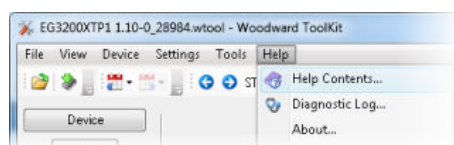

Fig. 75: Help

i Please do not change the default installation folder! Otherwise the language selection will not work properly.

5.1.4 Connect ToolKit

Standard connection

To connect ToolKit and the LS-5 unit:

1. ▶



The USB/RS-232 serial interface is only provided via the optional Woodward DPC (direct configuration cable), which must be connected to the service port.

For additional information refer to Chapter 7.1.3.1 “Service Port (RS-232/USB)” on page 258.

Plug the DPC cable into the service port. Use a USB/null modem cable to connect the USB/RS-232 serial port of the DPC to a serial USB/COM port of the PC.



If the PC does not have a serial port to connect the null modem cable to, use a USB to serial adapter.

2. ▶ Open ToolKit from the Windows Start Menu path “Programs → Woodward → ToolKit 5.x”.

3. ▶ From the main ToolKit window, select “File → Open Tool...” click the “Open Tool” icon  on the tool bar.

4. ▶ Locate and select the desired tool file (*.WTOOL) in the ToolKit data file directory and click “Open”.

5. ▶ From the main ToolKit window, click Device then click “Connect”, or select the Connect icon  on the toolbar.

⇒ The connect dialog will open if the option is enabled.

6. ▶ Select the COM port that is connected to the communication cable.

7. ▶ Click the “Connect” button.

⇒ The identifier of the device that ToolKit is connected to, will display in the status bar.

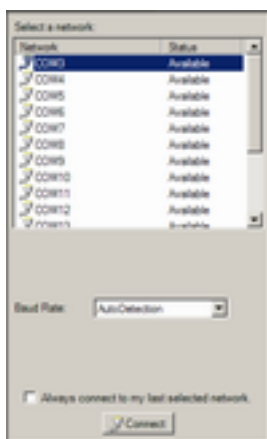

Fig. 76: Connect dialog



Fig. 77: Communications window

8. ▶ If the communications window opens, select “ToolConfigurator” from the “Tool Device” list and close the communications window.

⇒ If the device is security enabled, the login dialog will appear.

9. Enter the login data if required.
 - ⇒ Now you are able to edit the LS-5 parameters in the main window.



Any changes are written automatically to the control unit's memory after pressing [Enter] to confirm them..

CAN bus connection

It is also possible to connect to the unit via CAN bus, if a suitable CAN adapter is used.



We recommend to use the IXXAT USB-to-CAN converter which must use the VCI V3 driver.

To connect ToolKit via CAN:

1. Install the required drivers of the USB-to-CAN converter.
2. Connect the unit.
3. Open ToolKit and select a tool.
4. Select "Connect".
5. Select the CAN connection in the "Connect" window.
6. Configure the correct baud rate and timeout in the properties dialog of the "Connect" window.



The Password for CAN Interface 1 (parameter 10402 ↗ p. 72) must be entered before being able to edit the parameters via CAN.

CAN connection troubleshooting

Fault description	Cause	Remedy
Connection error (ToolKit freezes when trying to establish a connection)	Active connections via infrared ports	Temporarily deactivate the infrared port (including virtual ports)
	Active connections via bluetooth	Temporarily deactivate bluetooth (including virtual ports)
	Additional CANopen devices connected to the bus	Contact Woodward support or provide missing .sid file for additional CANopen device (↗ "SID files for additional CANopen devices" on page 159)

SID files for additional CANopen devices

When connecting a PC to the LS-5 via CAN bus, other external CANopen devices (like a Phoenix Contact I/O expansion board, for example) may cause ToolKit to fail to connect.

A cause may be that ToolKit looks for a SID file for the external device, which does not exist.

A special *.sid file can be created in this case.



For additional support feel free to contact Woodward.

- Create a SID (text) file with the following content:

```
<?xml version="1.0" encoding="utf-8"?>
<ServiceInterfaceDefinition
  xmlns:xsi="http://www.w3.org/
    2001/XMLSchema-instance"
  Identifier="[device application name]"
  Specification="EmptyFile">
</ServiceInterfaceDefinition>
```
- Name the file [CANopen device identifier].sid
- Store the file in the configured SID directory

5.1.5 View And Set Values In ToolKit

Basic navigation

ToolKit offers the following graphical elements for basic navigation:

Graphical element	Caption	Description
	Navigation buttons	Select main and subordinate configuration pages
	Navigation list	To directly select a configuration page based on its name
	Buttons "Previous page" and "Next page"	To go to the previous/next configuration page (as ordered in the list)

Value and status fields

Graphical element	Caption	Description
	Value field	To directly input (alpha)numeric values
	Option field	To select from a preset list of options
	Connection status field	Displays active port and unit connection status

To change the value of a value or option field:

1. Enter the value or select an option from the drop-down list.
2. Press *[Enter]* to confirm.
 - ⇒ The new value is written directly to the unit.

Visualization



Values displayed by visualization graphical elements cannot be changed.

Graphical element	Caption	Description
	System setup visualization	Displays breaker status
	Warning indicator	Displays status of warning alarms [on/off]
	Error indicator	Displays status of shutdown alarms [on/off]
	Valid indicator	Status is valid
	Invalid indicator	Status/alarm is invalid

Search

To find specific parameters, settings and monitoring values more easily, ToolKit includes a full-text search function.

To find a parameter/setting/monitoring value:

1. Select *Tools* → *Search* from the menu.
 - ⇒ The *Search* dialog opens.
2. Enter a search term and press *[Enter]*.
 - ⇒ The results are displayed in the table.
3. Double-click a table entry to go to the visualization/configuration page that includes this parameter/setting/monitoring value.

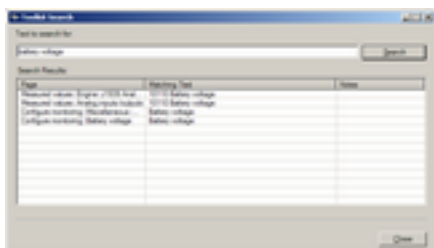

Fig. 78: Search dialog

Value trending

The value trending view can chart up to sixteen values over time.

To select values for trending screen:

1. Right-click an analog value field on any configuration/visualization page and select *Add to trend* from the context-menu.
 - ⇒ The trending screen opens.
2. Click the *Start* button to initiate charting.
3. Click the *Stop* button to stop charting the values.

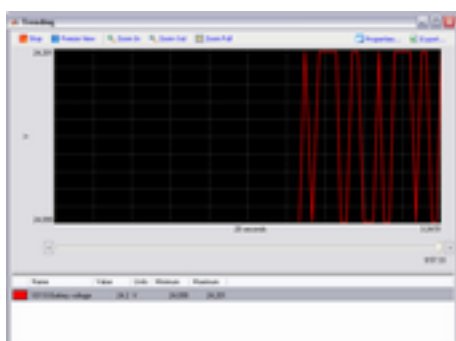



Fig. 79: Trending screen

4.  To store the tracked data select *“Export”*
 - ⇒ The tracked data is exported to a .HTM file which can be viewed/edited/analyzed in external applications.

Graphical element	Caption	Description
 Start	<i>“Start”</i>	Start value charting
 Stop	<i>“Stop”</i>	Stop value charting
 Zoom In  Zoom Out  Zoom Full	Zoom controls	Adjust detail of value chart
 Export...	<i>“Export”</i>	Export to .HTM
 Properties....	<i>“Properties”</i>	Change scale limits, sample rate, time span, colors

5.1.6 Special Screens

The following ToolKit screens provide overviews to the states of connected easYgen and LS-5 units in the network.

States easYgen

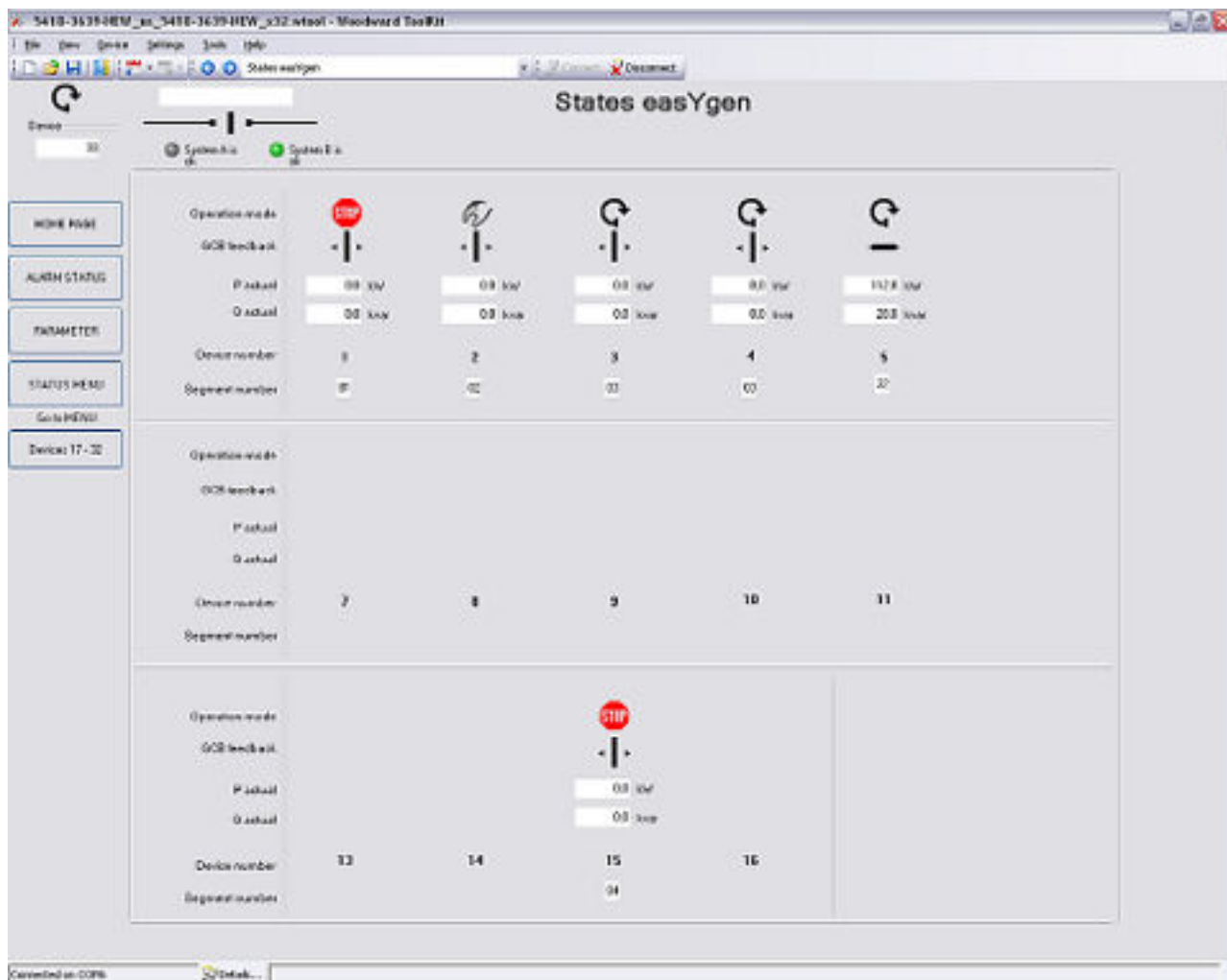







Fig. 80: States easYgen

Symbol	Description
	Operating mode STOP is active.
	Operating mode MANUAL is active.
	Operating mode AUTOMATIC is active.
	Breaker is open.
	Breaker is closed.

States LS-5

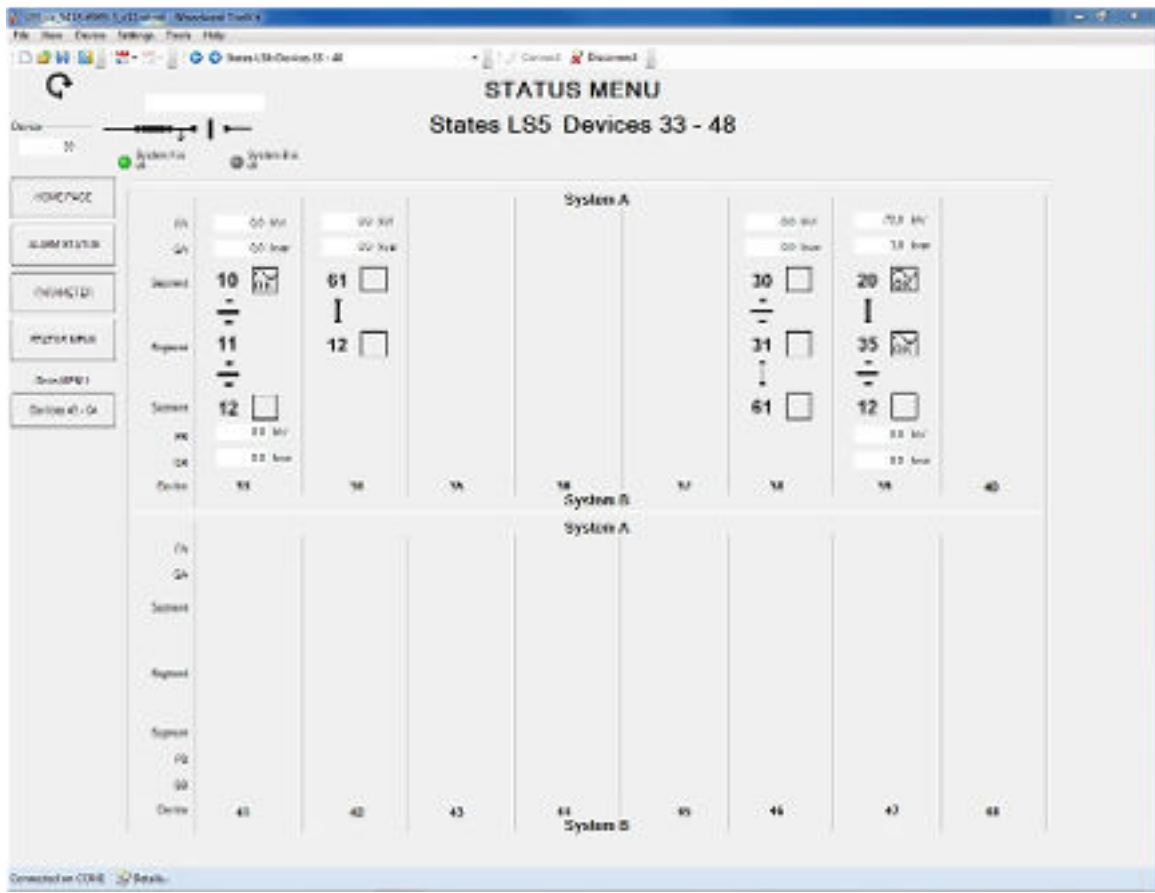









Fig. 81: States LS-5

Symbol	Description
	Voltage is below dead bus limit.
	Voltage is higher than dead bus limit but not in range.
	Voltage and frequency are in operating range.
	Breaker is open.
	Breaker is closed.
	Isolation switch is open.
	Isolation switch is closed.

Segments LS-5

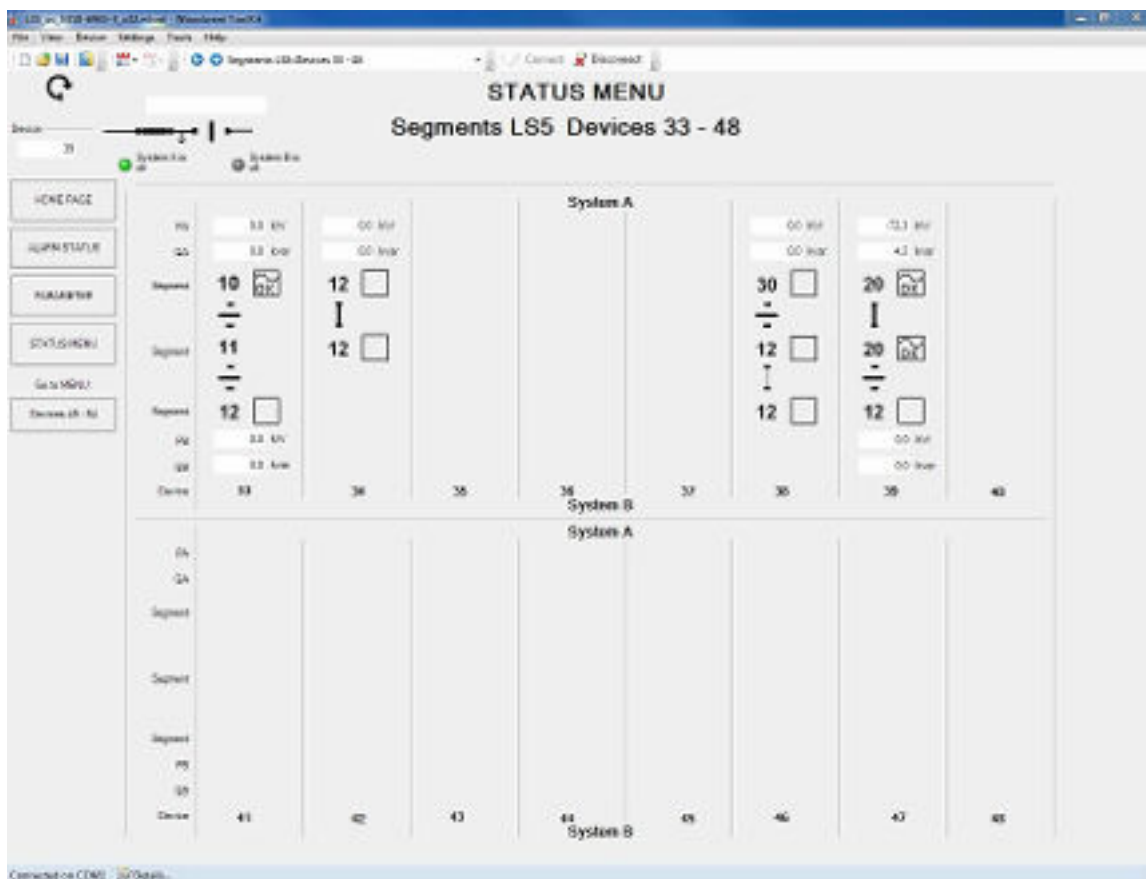









Fig. 82: Segments LS-5

Symbol	Description
	Voltage is below dead bus limit.
	Voltage is higher than dead bus limit but not in range.
	Voltage and frequency are in operating range.
	Breaker is open.
	Breaker is closed.
	Isolation switch is open.
	Isolation switch is closed.

CAN Interface 1 State

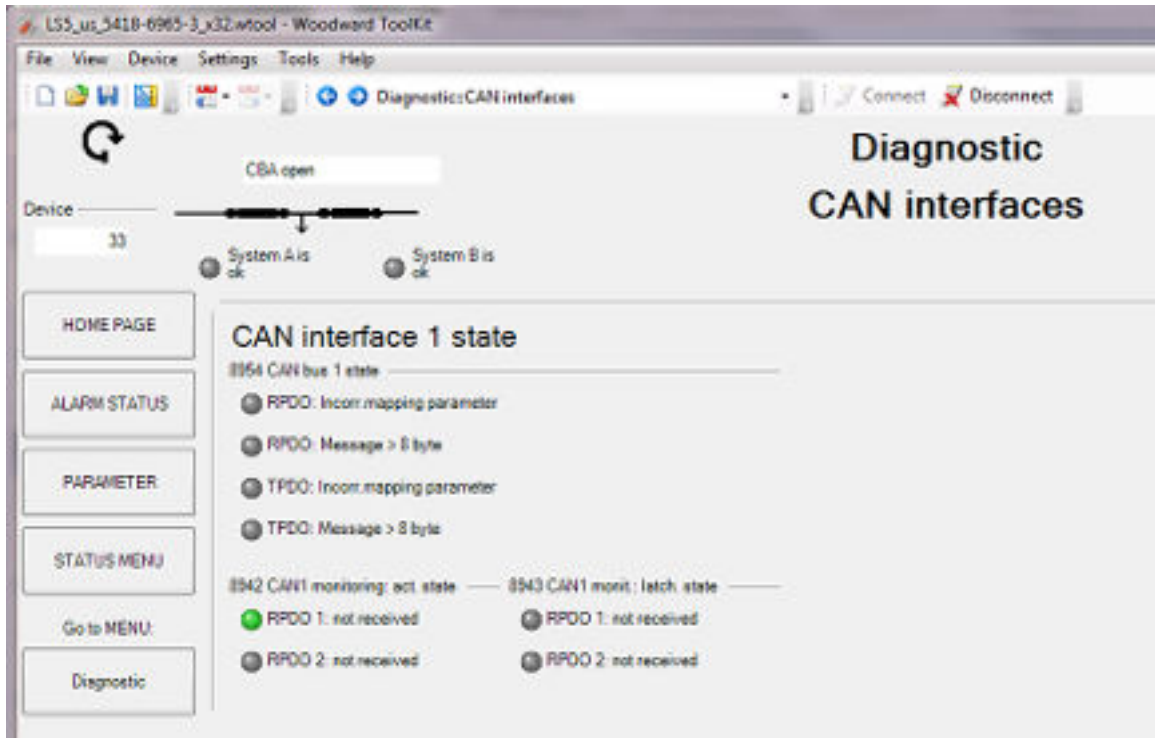

Fig. 83: CAN interface state screen (example)

ID	Section	Bit	Assignment
8954	CAN bus 1 state	1	A TPDO has incorrect mapping parameters
		2	An RPDO has incorrect mapping parameters
		3	A TPDO has more than 8 bytes
		4	An RPDO has more than 8 bytes
8942	CAN 1 monitoring (active state)	{x}	RPDO {x} is not received at the moment
8943	CAN 1 monitoring (latched state)	{x}	RPDO {x} has not been received

Table 34: Bit assignment

5.2 Front Panel Access

5.2.1 Basic Navigation

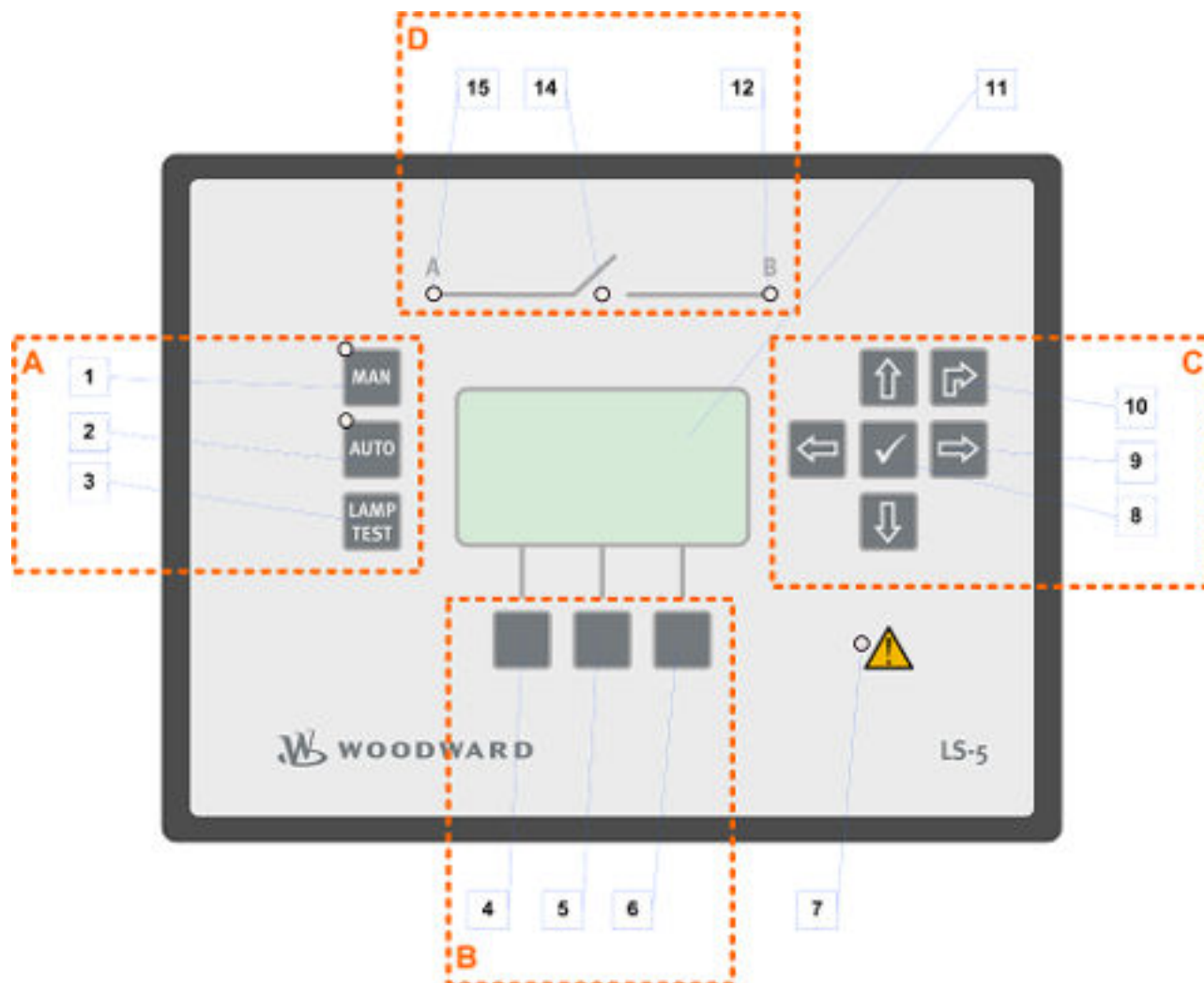







Fig. 84: Front panel and display





- A (1..3) Button group "Hardware"
- B (4..6) Button group "Display" (Softkeys)
- (7) LED Alarm messages present
- C (8..10) Button group "Navigation" (Softkeys)
- (11) Display
- D (12..15) LEDs "Breaker/system states" (13 reserved for 2breaker variant)

The picture above shows the front panel/display of the LS-52x with buttons, LEDs and LCD display. A short description of the front panel is given below.



[A] Button group "Hardware"





No.	Button	Function (all screens)
1		<p>Change into MANUAL operating mode. The LED indicates that the operation mode is active.</p> <p>When MANUAL is selected, breaker control is performed manually via the button  (No. 5).</p> <p>If the control unit is configured to application mode  and  (parameter 8840 ↗ p. 120) the button has no function.</p>
2		<p>Change into AUTOMATIC operating mode. The LED indicates that the operation mode is active.</p> <p>When AUTOMATIC is selected, the control unit manages all breaker control functions. These functions are performed in accordance with how the control unit is configured.</p>
3		Perform lamp test.

[B] Button group "Display" (Soft-keys)



No.	Button	Function (main screen)	Function (other screens)
4		<p>Toggle between delta/bye voltage display. The index of the "V" symbol indicates whether delta or wye voltage is displayed and which phases are displayed.</p> <p>Refer to ↗ Table 37 "Measuring voltage values system A page one" on page 176.</p>	The push button has only a function if a graphic icon is assigned.
5		<p>AUTOMATIC operating mode: No function.</p> <p>MANUAL operating mode: OPEN / CLOSE breaker according to graphic icon on display.</p>	The push button has only a function if a graphic icon is assigned.
6		No function.	The push button has only a function if a graphic icon is assigned.
7		The LED indicates that alarm messages are active/present in the control unit.	

[C] Button group "Navigation"

No.	Button	Function (main screen)	Function (other screens)
8		Reset "Horn".	Enter / Acknowledge
9		Display the "Alarm list" screen.	Scroll up / Raise value

No.	Button	Function (main screen)	Function (other screens)
		Display the "Main menu" screen.	Scroll down / Lower value
		Display the "Parameter" screen.	Scroll right
		No function.	Scroll left / Enter menu (if graphic icon is assigned)
10		No function.	Return to last screen

[D] LEDs "Breaker/system states"

No.	Button	Function (all screens)
12		The LED indicates three states: Off: Voltage is below dead bus limit (parameter 5820 ↪ p. 120). Blinking: Voltage higher than dead bus limit (parameter 5820 ↪ p. 120) but voltage or frequency are not in range. On: Voltage / frequency in operating range.
14		The LED indicates two states: Off: Breaker A is open. On: Breaker A is closed.
15		The LED indicates three states: Off: Voltage is below dead bus limit (parameter 5820 ↪ p. 120). Blinking: Voltage higher than dead bus limit (parameter 5820 ↪ p. 120) but voltage or frequency are not in range. On: Voltage / frequency in operating range.

Display / main screen

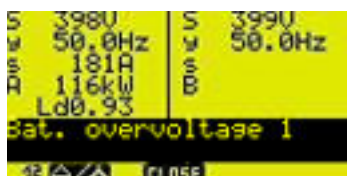

Fig. 85: Main screen (example)

The display shows context-sensitive softkey symbols, measuring values, operation modes and alarms.

After power-up the control unit displays the main screen.

The main screen contains the following basic sections:

No	Display section	Function
11		<p>SysA: Shows the System A values, page one.</p> <p>SysB: Shows the System B values, page one .</p> <p>Notes</p> <p>Refer to Further information on page 176 for monitored values details.</p>
		This display section shows the "Status Messages" and "Alarm Messages".
		This display section shows a symbol indicating the selected display mode. Refer to Further information on page 176 for details.
		This display section shows a symbol indicating the breaker state ("open"/"close") that is initiated by pressing the associated button. The icon is only displayed in operating mode "MANUAL".



If the control unit has been configured for external operating mode selection, the "AUTO" and "MAN" buttons have no function. The operating mode cannot be changed.

Softkeys

The softkeys ([Further information on page 167B](#)) permit navigation between screens, levels and functions as well as configuration and operation.

Softkey symbol	Caption	Description
	Increase	Increase value.
	Decrease	Decrease value.
	Help	Access help screen.
	Toggle	Toggle between the configurable elements.
	Reset	Reset the maximum value display.

Status symbols

Menu screen	Symbol	Description
Alarm List		Indicates that corresponding alarm condition is still present.
States easYgen		STOP operating mode.
		MANUAL operating mode.

Menu screen	Symbol	Description
		AUTOMATIC operating mode.
		Breaker open (GCB).
		Breaker closed (GCB).
		Segment number.
		Device number.
States LS-5 and Segments LS-5		Segment numbers and breaker open.
		Segment numbers and breaker closed.
		Segment numbers and isolation switch open.
		Segment numbers and isolation switch closed.
		Indicates voltage and frequency are in range.
		Indicates voltage or frequency are not in range.
		Own LS-5 device number.
		Other LS-5 device numbers.
Decoupling thresholds		Indicates that value is part of system A decoupling.
Various screens		Variable is TRUE (LogicsManager). The bit is enabled (CAN interface). Relay activated (Discrete outputs)
		Variable is FALSE (LogicsManager). The bit is disabled (CAN interface). Relay deactivated (Discrete outputs)

Menu structure

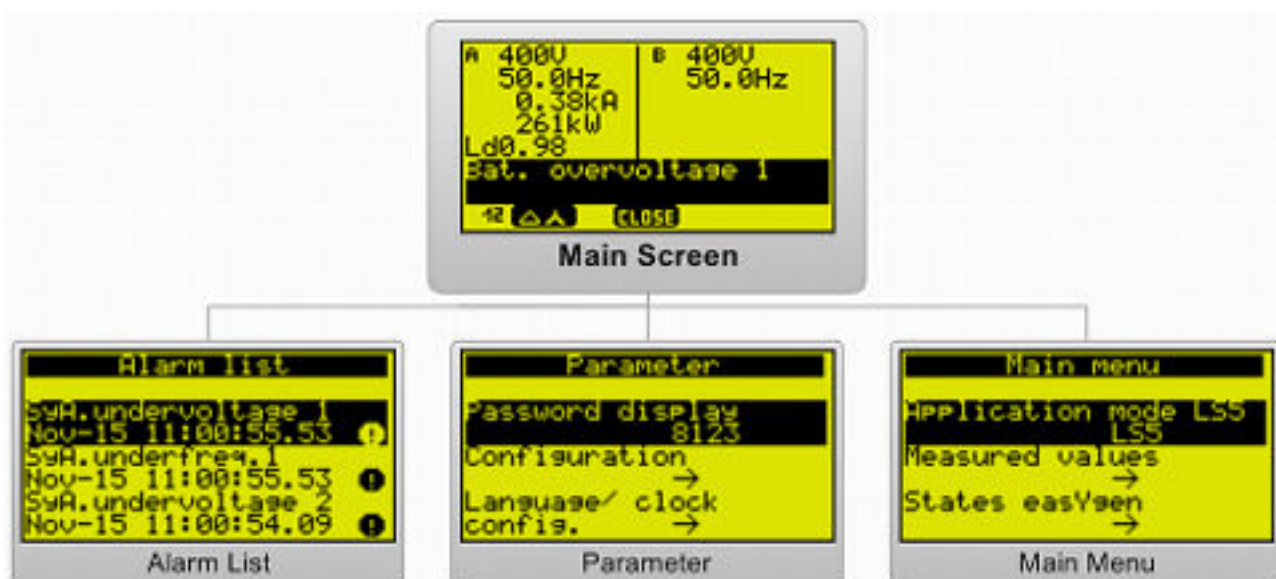

Fig. 86: Menu structure

Menu structure "Parameter"

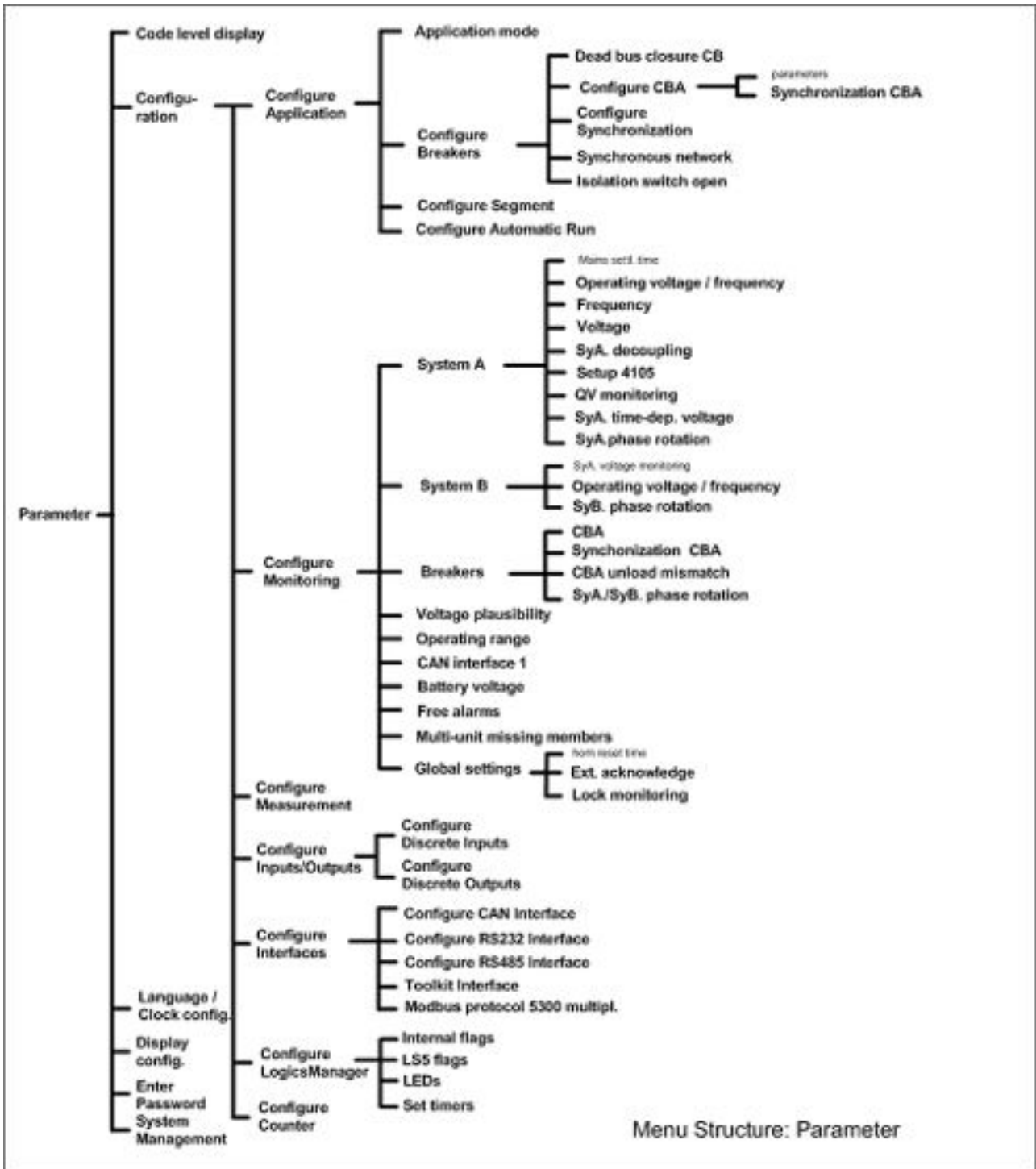

Fig. 87: Menu structure - Parameter

Menu structure "Main menu"

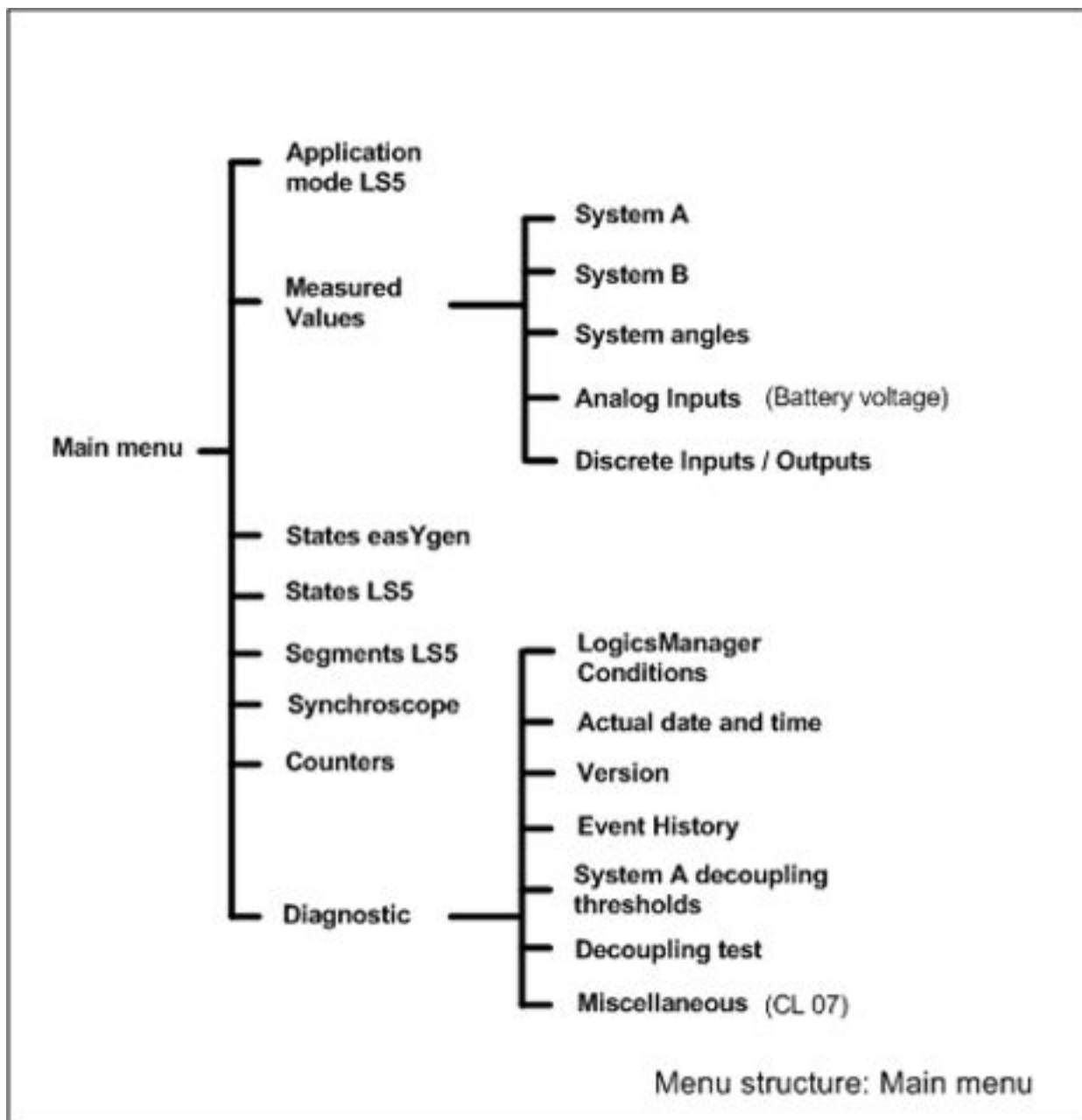

Fig. 88: Menu structure - Main menu



The following chapters list notes on specific menu screens.

For information on standard softkeys and status symbols refer to [Chapter 5.2.1 "Basic Navigation"](#) on page 167.

5.2.2 Parameter Setting Screens



The following chapters list standard menu screens, where all user input is handled similarly.

For information on standard softkeys and status symbols refer to [Chapter 5.2.1 “Basic Navigation”](#) on page 167.

For information on all other menu screens refer to [Chapter 5.2.3 “Main Menu Screens”](#) on page 176.

5.2.2.1 Navigation Screens



Fig. 89: Navigation screen (example)

Navigation screens offer access to sub-menu screens via the dedicated buttons.

Navigation screens:

- Main Menu
- Measured values
- Diagnostic
- Parameter
- Configuration

➔ Use the following buttons to change to a sub-menu screen.



Sub-menu entries are only displayed if the required or a higher code level is set.

Symbol/Button	Description
↑	Scroll up one row.
↓	Scroll down one row.
✓	Change to the selected sub-menu screen.
↶	Return to the previous sub-menu screen.

5.2.2.2 Value Setting Screens









Fig. 90: Value setting screen (example)

Screen	Notes
Application mode LS-5	Set the current application mode.
Application configuration	---
Monitoring configuration	---
Measurement configuration	---
Interfaces configuration	---

Screen	Notes
Counters configuration	---
Language / clock configuration	---
Display configuration	Allows the display contrast to be configured.
Enter password	Allows the password to be entered for a specific code level.
System Management	---

Table 35: Value setting screens

➔ Use the following buttons in a value setting screen to select, change and confirm a setting.

Button/Softkey	Description
	Select previous digit of selected value.
	Select next digit of selected value.
	Increase selected value.
	Decrease selected value.
	Confirm and store changed value.
	Return without any changes.







5.2.2.3 LogicsManager Setting screens



Fig. 91: LogicsManager screen

Some parameters of the LS-5 are configured via the Logics-Manager.

➔ Configure a logical operation using various command variables, signs, logical operators, and delay times to achieve the desired logical output.

Symbol/Button	Description
	Scroll up one command variable within section.
	Scroll down one command variable within section.
	Navigate to next command variable section
	Toggle between the configurable elements.
	Confirm the configured option of the selected Logics-Manager parameter.
	Show help screen (displays logical operators)

5.2.3 Main Menu Screens

5.2.3.1 Main Screen Display



Fig. 92: LS-5x1 Main screen (example)



The amount of information available from the system depends on how the measuring is configured in the control unit.

The following values can be shown:

Value	Monitoring	Notes
System A voltage	L1-L2 / L2-L3 / L3-L1 / L1-N / L2-N / L3-N	changeable - see table below
System A frequency	average	
System A current	average	
System A active power	total	
System A power factor	average	
System B voltage	L1-L2 / L2-L3 / L3-L1 / L1-N / L2-N / L3-N	changeable - see table below
System B frequency	average	

Table 36: Measuring values page one

The voltage display softkey  on the main screen changes the type of voltage display (1st row).

The following table illustrates what voltage values for system A and system B are available depending on the configured measurement type:

Press  below x times	Symbol (lower left)	Monitoring	Displayed at parameter setting				
			3Ph4W	3Ph4WOD	3Ph3W	1Ph2W	1Ph3W
0x (6x)	12	Delta L1-L2	Yes	Yes	Yes	Yes ¹	—
1x	23	Delta L2-L3	Yes	Yes	Yes	—	—
2x	31	Delta L3-L1	Yes	Yes	Yes	—	Yes
3x	1	Wye L1-N	Yes	—	—	Yes ¹	Yes
4x	2	Wye L2-N	Yes	—	—	—	—
5x	3	Wye L3-N	Yes	—	—	—	Yes

Table 37: Measuring voltage values system A page one

Press  below x times	Symbol (lower left)	Monitoring	Displayed at parameter setting			
			3Ph4W	3Ph3W	1Ph2W	1Ph3W
0× (6×)	12	Delta L1-L2	Yes	Yes	Yes ¹	—
1×	23	Delta L2-L3	Yes	Yes	—	—
2×	31	Delta L3-L1	Yes	Yes	—	Yes
3×	1	Wye L1-N	Yes	—	Yes ¹	Yes
4×	2	Wye L2-N	Yes	—	—	—
5×	3	Wye L3-N	Yes	—	—	Yes

Table 38: Measuring voltage values system B page one



¹ depends on setting of parameter 1858 ↪ p. 76.

5.2.3.2 Alarm List



Fig. 93: Alarm List screen (example)



All alarm messages, which have not been acknowledged and cleared, are displayed. Each alarm is displayed with the alarm message and the date and time of the alarm occurred in the format mon-dd hh:mm:ss.ss.



Self-acknowledging alarm messages get a new timestamp when initializing the unit (switching on).



A maximum of 16 alarm messages can be displayed. If 16 alarm messages are already displayed and further alarm messages occur, these will not be displayed before displayed alarm messages are acknowledged and thus deleted from the list.

Symbol/Button	Description
	Indicates that corresponding alarm condition is still present.
	Acknowledge the selected alarm message (displayed inverted).



Acknowledgment is only possible, if the alarm condition is no longer present. If the Alarm LED is still flashing (an alarm is present, which has not yet been acknowledged as 'Seen'), this softkey resets the horn and acknowledges the alarm as 'Seen'.

5.2.3.3 System A



Fig. 94: Measured values system A screen (example)

Displays all measured AC values system A.

Unit	Value
V	Voltage
A	Current
kW	Active power
kvar	Reactive power
Hz	Frequency
Lg	Lagging
Ld	Leading

Table 39: Units of measured values

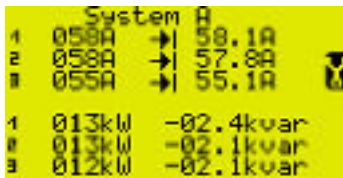

Fig. 95: Slave pointer system A screen (example)

Displays the measured and the maximum AC current system A.

Symbol/Button	Description
	Reset the maximum value display.

5.2.3.4 System B

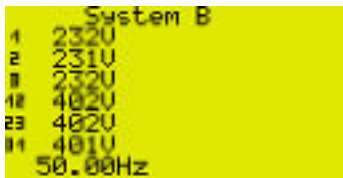

Fig. 96: Measured values system B screen (example)

Displays all measured AC values system B.

Unit	Value
V	Voltage
Hz	Frequency

Table 40: Units of measured values

5.2.3.5 System Angles

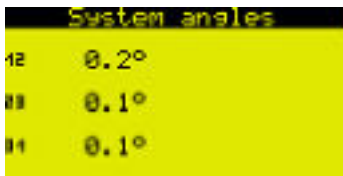

Fig. 97: System angles screen (example)

Displays the real system angles between system A and system B without phase angle compensation (parameter 8824 ↩ p. 125).

5.2.3.6 Synchroscope

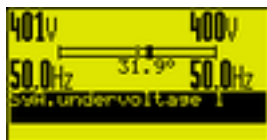

Fig. 98: Synchroscope screen (example)

The square symbol indicates the actual phase angle between system A and system B. A complete left position of the square symbol means -180° and complete right position means $+180^\circ$.

The frequency and voltage values of system A (left side) and system B (right side) are indicated in the display.



The shown value is not the real angle between system A and system B if the phase angle compensation (parameter 8824 ↗ p. 125) is active.

Symbol/Button	Description
	Indicates the actual phase angle (here: $+31.9^\circ$) between system A and system B.

5.2.3.7 LogicsManager Conditions



Fig. 99: LogicsManager conditions screen (example)

This screen displays the conditions of all LogicsManager command variables, which are located in their respective groups.



Fig. 100: Command variables screen (example)

Symbol/Button	Description
<input checked="" type="checkbox"/>	Select the highlighted command variable group and display the state of the command variables in this group.
<input type="checkbox"/>	Variable is TRUE.
<input type="checkbox"/>	Variable is FALSE.

5.2.3.8 Event History



Fig. 101: Event History screen (example)

This screen displays system events. A date/time stamp in the format `mon-dd hh:mm:ss.ss` is added to each entry.

All alarm messages, which have not been acknowledged and cleared, are displayed.

Symbol/Button	Description
+	Indicates a condition that is still active.
-	The condition is no longer present.

5.2.3.9 States easYgen



Fig. 102: States easYgen screen (example)

This screen displays the states of the easYgen devices.

Status symbols

Symbol	Description
	STOP operating mode.
	MANUAL operating mode.
	AUTOMATIC operating mode.
	Breaker open (GCB).
	Breaker closed (GCB).
	Segment number.
	Device number.

5.2.3.10 States LS-5



Fig. 103: States LS-5 screen (example)

This screen displays the states of the LS-5 devices.

Status symbols

Symbol	Description
	"A": System A side
	Segment numbers and breaker open.
	Segment numbers and breaker closed.
	Segment numbers and isolation switch open.
	Segment numbers and isolation switch closed.
	Indicates voltage and frequency are in range.
	Indicates voltage or frequency are not in range.
	Own LS-5 device number.
	Other LS-5 device numbers.

5.2.3.11 Segments LS-5

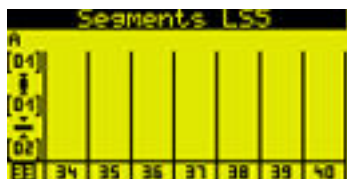

Fig. 104: Segments LS-5 screen (example)

This screen displays the segments of the LS-5 devices.

Status symbols

Symbol	Description
	"A": System A side
	Segment numbers and breaker open.
	Segment numbers and breaker closed.
	Segment numbers and isolation switch open.
	Segment numbers and isolation switch closed.
	Indicates voltage and frequency are in range.
	Indicates voltage or frequency are not in range.
	Own LS-5 device number.
	Other LS-5 device numbers.

5.2.3.12 Discrete Inputs/Outputs

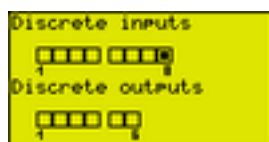

Fig. 105: Discrete inputs/outputs screen (example)

This screen displays discrete inputs' and discrete outputs' status.



The configured logic for the discrete input "N.O./N.C." will determine how the LS-5 reacts to the state of the discrete input. If the respective DI is configured to N.O., the unit reacts on the energized state; if it is configured to N.C., it reacts on the de-energized state.

Type	Symbol	State
Input		energized
		de-energized
Output		relay activated
		relay de-activated

5.2.3.13 Analog Input



This screen displays the battery voltage.

Fig. 106: Battery voltage screen (example)

5.2.3.14 System A Decoupling Thresholds



Restricted Access

The function 'System A Decoupling Thresholds' is available on Code level CL3. Code levels CL0 to CL2 are intentionally not supported. Refer to chapter 4.1.3 "Enter Password" on page 71 for details.



Softkey	Description
TEST ON	Starts a test mode which allows a comfortable system A decoupling configuration.
TEST OFF	Stops a test mode which allows a comfortable system A decoupling configuration.

Fig. 107: Status of test (example)



Softkey	Description
+	Increments decoupling value setpoint. When pressing the button permanent the value changes faster.
-	Decrements decoupling value setpoint. When pressing the button permanent the value changes faster.



Symbol	Description
#	Indicates parameters that are part of the system A decoupling configuration.

Fig. 108: For decoupling valid / not valid (example)

The buttons **↓** and **↑** navigate through the following thresholds which can be adjusted:



Fig. 109: Decoupling overvoltage (example)



Fig. 110: Decoupling voltage increase (example)



Fig. 111: Decoupling phase shift (example)



Fig. 112: Decoupling breaker (example)

The following values are treated similar:

- Overvoltage level 1 (↪ Chapter 4.3.1.7 “System A Overvoltage (Level 1 & 2) ANSI# 59” on page 87)
- Overvoltage level 2 (↪ Chapter 4.3.1.7 “System A Overvoltage (Level 1 & 2) ANSI# 59” on page 87)
- Undervoltage level 1 (↪ Chapter 4.3.1.8 “System A Undervoltage (Level 1 & 2) ANSI# 27” on page 88)
- Undervoltage level 2 (↪ Chapter 4.3.1.8 “System A Undervoltage (Level 1 & 2) ANSI# 27” on page 88)
- Overfrequency (↪ Chapter 4.3.1.5 “System A Overfrequency (Levels 1 & 2) ANSI# 81O” on page 85)
- Underfrequency (↪ Chapter 4.3.1.6 “System A Underfrequency (Level 1 & 2) ANSI# 81U” on page 86)
- Voltage increase (↪ Chapter 4.3.1.10 “System A Voltage Increase” on page 91)

The following values are treated similar:

- Phase shift 3-phase (↪ Chapter 4.3.1.3 “Phase Shift” on page 82)
- Phase shift 1-phase (↪ Chapter 4.3.1.3 “Phase Shift” on page 82)
- DfIdt (↪ Chapter 4.3.1.3 “Phase Shift” on page 82)
- Breaker for decoupling [CBA], [Off]

5.2.3.15 Test System A Decoupling (VDE-AR-N 4105)

VDE AR-N 4105 is asking for a test button.

The system A decoupling test opens the selected breaker for decoupling.



Restricted Access

The function 'System A Decoupling Test' is available on Code level CL3. Code levels CL0 to CL2 are intentionally not supported. Refer to chapter ↪ Chapter 4.1.3 “Enter Password” on page 71 for details.

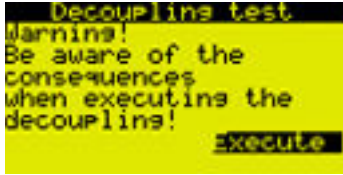

Fig. 113: Security query system A decoupling test

Softkey	Description
Execute	Opens immediately the breaker that is configured for decoupling.



This function is independent from the breaker status and is active for 1 sec.

5.2.3.16 Counters

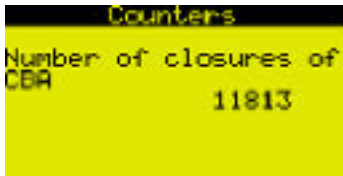

Fig. 114: CBA close counter screen (example)

Displays the CBA close counter.

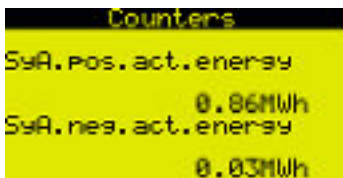

Fig. 115: Active energy screen (example)

Displays the active energy of system A.

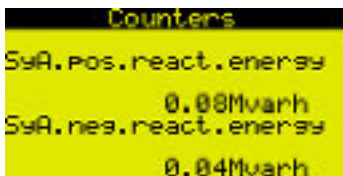

Fig. 116: Reactive energy screen (example)

Displays the reactive energy of system A.

5.2.3.17 Actual Date And Time



Fig. 117: Actual date and time screen (example)

Displays the actual date and time. Format is: YYYY-MMM-DD and hh:mm:ss

5.2.3.18 Version

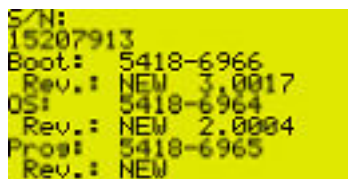

Displays the serial number of the unit and the firm- and software P/N, version, and revision.

Fig. 118: Version screen (example)

5.3 Change Operating Modes

Startup

The LS-5 starts in the operating mode defined by parameter 8827 ↪ p. 131.

Select Operating Mode

The operating mode can be selected via

- front panel buttons (plastic housing variant) or
- LogicsManager configuration

This chapter describes the manually front panel access. Please refer to chapter ↪ Chapter 4.4.4 “Automatic Run” on page 131 how to change the operating mode via LogicsManager.

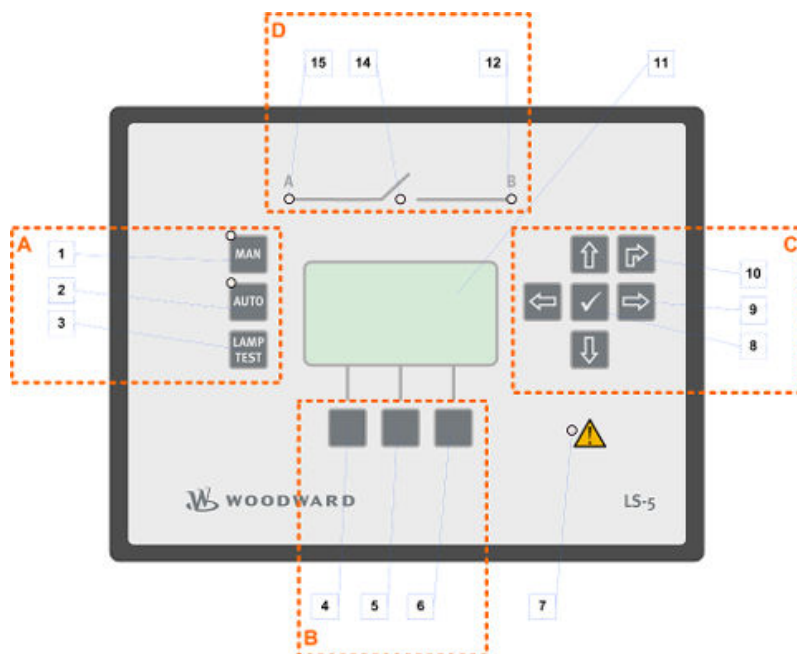

Fig. 119: LS-521 v2, 1breaker front panel

- 1 Mode button: MAN
- 2 Mode button: AUTO
- 5 Soft button: Breaker OPEN/CLOSE

5.3.1 Operating Mode MANUAL

General usage

In the MANUAL operating mode (LED at mode button “MAN” illuminated) the circuit breakers can be operated via the push buttons along the bottom of the display (softkeys) at the screens listed below.



- Use the mode button “MAN” to activate operating mode MANUAL.
- ⇒ The LED at the MAN button is illuminated



*If the control unit is configured to application mode **A05** (parameter 8840 ↪ p. 120) the button has no function.*



NOTICE!

Refer to the according settings of the breakers to determine the reaction caused by opening a breaker.

Main screen

The opening and closing of the breakers can be initiated via softkeys.

Synchroscope

The synchronization of the breakers can be initiated via softkeys.



Fig. 120: LS-5x1 Synchroscope in operating mode MANUAL (example)

5.3.2 Operating Mode AUTOMATIC

General usage

In the AUTOMATIC operating mode (LED at mode button “AUTO” illuminated), the circuit breaker functions are operated via an interface, or automatically by the control unit (i.e. a mains failure).



The function of the LS-5 depends on the configuration of the unit and how the external signals are used.



- Use the button “AUTO” to activate operating mode AUTOMATIC.
- ⇒ If mode change was successful the LED at the button “AUTO” is illuminated.

5.4 Restore Language Setting

Due to the multilingual capability of the unit, it may happen that the display language of the LS-5 is set to a language, the operator is unable to read or understand.

In this case, the following proceeding helps to restore the desired language.



The default setting is English.

In order to change the language setting, press the softkeys in the following order:



Fig. 121: Front panel and display

1. Press softkey until you return to the starting screen (as shown in Fig. 121).
3. Press softkey once to access the "Parameter" screen.
4. Press softkey twice to access the "Language / clock config." screen.
5. Press softkey twice to edit the language setting.
6. Press softkey to select the desired language.
7. Press softkey once to commit the language setting.
 - ⇒ The desired display language is restored.

6 Application

6.1 Application Modes Overview

General notes

The LS-5 circuit breaker control units are designed to enable complex power management applications with multiple incoming mains and bus breakers in combination with easYgen-3400/3500 or easYgen-3400XT/3500XT equipped genset controllers.

This device combination allows to establish various applications. To make the handling for that wide range of applications easier, different preconfigured application modes in the LS-5 as well in the easYgen-3400/3500 or easYgen-3400XT/3500XT are provided.

These application modes are created because some pre-configurations are automatically fixed through the according application modes. The following chapter explains the differentiation of the application modes and there settings.



Not all possible configurations can be explained in detail, but shall help to guide through the settings according to the mode.

The control units can be used stand-alone (↪ [Chapter 6.1.1 “LS-5x1: Stand-Alone Application Mode” on page 190](#)) or common applications with Woodward easYgen-3400/3500 or easYgen-3400XT/3500XT genset control units (↪ [Chapter 6.1.2 “LS-5x1 & easYgen-3400/3500 or easYgen-3400XT/3500XT: Common Application Modes” on page 190](#), ↪ [Chapter 6.3 “Setup easYgen & Slave LS-5 Applications \(Mode A03 & A04\)” on page 196](#), ↪ [Chapter 6.4 “Setup easYgen & Independent LS-5 Applications \(Mode A02\)” on page 215](#) and ↪ [Chapter 6.5 “Setup VDE-AR-N 4105 Applications” on page 250](#)).



For detailed information on the application modes, notes on safety and examples of special applications refer to the following chapters:

- ↪ [Chapter 6.2 “Setup Stand-Alone Applications \(Mode A01\)” on page 193](#)
- ↪ [Chapter 6.3 “Setup easYgen & Slave LS-5 Applications \(Mode A03 & A04\)” on page 196](#)
- ↪ [Chapter 6.4 “Setup easYgen & Independent LS-5 Applications \(Mode A02\)” on page 215](#)

Correlating application modes

	LS-511/521		easYgen-3400/3500 or easYgen-3400XT/3500XT	
	Mode	Symbol	Mode	Symbol
LS-5	Single LS5		N/A	N/A
LS-5 & easYgen	LS5 (up to 16 unit)		GCB/LS5	
	L-MCB (max. 1 unit)		GCB/L-MCB	
			GCB/GGB/L-MCB	
	L-GGB (max. 1 unit)		GCB/L-GGB	
GCB/L-GGB/L-MCB				

6.1.1 LS-5x1: Stand-Alone Application Mode





LS-511/521		easYgen-3400/3500 or easYgen-3400XT/3500XT		
Mode	Symbol	Mode	Symbol	Function
Single LS5		None	None	<p>Independent synch check relay mode.</p> <p>This application mode provides the following functions:</p> <ul style="list-style-type: none"> ■ Handling of CBA (dead bus closure, synchronization, open) initiated by the corresponding command variables or by manual commands. ■ Measuring and monitoring of system A values (voltage, frequency, phase rotation, current). ■ Measuring of system B values (voltage, frequency, phase rotation). ■ Measuring of active and reactive power on system A. ■ Measuring of phase angle system A to system B. ■ Interacting as an independent synchronizer for a PLC by communication interface (CANopen, Modbus RTU slave).

6.1.2 LS-5x1 & easYgen-3400/3500 or easYgen-3400XT/3500XT: Common Application Modes



For information on the easYgen genset control unit's application modes refer to the easYgen manual.

6.1.2.1 LS-5x1 View

LS-511/LS-521		easYgen-3400/3500 or easYgen-3400XT/3500XT		
Mode	Symbol	Mode	Symbol	Function
LS5		GCB/LS5		<p>Open LS-5 system, in combination with easYgen-3400/3500 or easYgen-3400XT/3500XT, individually configurable.</p> <p>This application mode provides the following functions:</p> <ul style="list-style-type: none"> ■ Handling of CBA (dead bus closure, synchronization, open) initiated by the corresponding command variables or by manual commands. ■ Measuring and monitoring of system A values (voltage, frequency, phase rotation, current). ■ Measuring of system B values (voltage, frequency, phase rotation). ■ Measuring of active and reactive power on system A. ■ Measuring of phase angle system A to system B. ■ Recognition of segments within the easYgen / LS-5 system. ■ Dead bus arbitration with other easYgen and LS-5. ■ Mains decoupling function in the LS-5 configurable, for LS-5 connected with system A at mains.
L-MCB		GCB/L-MCB		<p>LS-5 as MCB control in combination with easYgen-3400/3500 or easYgen-3400XT/3500XT in a fixed application.</p> <p>This application mode provides the following functions:</p> <ul style="list-style-type: none"> ■ Handling of a MCB (dead bus closure, synchronization, open) initiated by the easYgen. ■ Measuring and monitoring of system A values, (mains voltage, mains frequency, mains phase rotation, mains current), transferred to easYgen.

LS-511/LS-521		easYgen-3400/3500 or easYgen-3400XT/3500XT		
Mode	Symbol	Mode	Symbol	Function
		GCB/GGB/L-MCB		<ul style="list-style-type: none"> Measuring of system B values, (voltage, frequency, phase rotation), transferred to easYgen. Measuring of mains active and mains reactive power on system A. Automatic configuration of the relevant parameters. Mains decoupling function in the LS-5 configurable.
L-GGB		GCB/L-GGB		<p>LS-5 as GGB control in combination with easYgen-3400/3500 or easYgen-3400XT/3500XT in a fixed application.</p> <p>This application mode provides the following functions:</p> <ul style="list-style-type: none"> Handling of a GGB (dead bus closure, synchronization, open) initiated by the easYgen. Measuring and monitoring of system A values (load voltage, load frequency, load phase rotation). Measuring of system B values (generator busbar voltage, -frequency, -phase rotation). Automatic configuration of the relevant parameters.





6.1.2.2 easYgen-3400/3500 or easYgen-3400XT/3500XT View

easYgen-3400/3500 or easYgen-3400XT/3500XT		LS-511/LS-521		
Mode	Symbol	Mode	Symbol	Function
GCB/LS5		LS5		<p>One or more easYgen in combination with an open LS-5 system, individually configurable for different application. Multiple isolated and/or mains parallel operation. (for max. possible number of easYgen and LS-5 see Notes below).</p> <p>This application mode provides the following functions:</p> <ul style="list-style-type: none"> Handling of the GCB (dead bus closure, synchronization, open) initiated by start command in AUTO or individually in MAN mode. Measuring and monitoring of generator values (voltage, frequency, phase rotation, current and power). Measuring of generator busbar values (voltage, frequency). Indicating of mains values (voltage, frequency) sent from 'Mains'-LS-5 with the smallest ID in the own segment. Indicating the sum of active and reactive power sent from all 'Mains'-LS-5 in the own segment. Regulating Import/Export power with the sum of active and reactive power sent from all 'Mains'-LS-5 in the own segment. The easYgen recognizes through the LS-5 system the active segment number. Connection to mains (MCB is closed) is recognized via the LS-5 system, if one or more "Mains"-LS-5 are available. The close and open commands for the single LS-5 breakers are usually not generated in the easYgen. Mains voltage and current is usually not connected at the easYgen. Run-up synchronization, acting on the GCB, is possible. <p>Notes</p> <p>The band width of the CAN bus allows to connect up to 32 easYgens in conjunction with up to 16 LS-5 devices. Theoretically up to 32 LS-5 are possible, but it requires a reduced number of easYgen devices. The amount of easYgen and LS-5 together should not exceed 48 devices, but to go sure please discuss the possible risks with your Woodward Sales Support.</p>

Application

Application Modes Overview > LS-5x1 & easYgen-3400/3500... > easYgen-3400/3500 or easYg...

easYgen-3400/3500 or easYgen-3400XT/3500XT		LS-511/LS-521		
Mode	Symbol	Mode	Symbol	Function
GCB/L-MCB		L-MCB		<p>One or more easYgen in combination with one LS-5 unit, acting on the MCB in a fixed application. Multiple isolated and/or mains parallel operation. The same handling as in the GCB/MCB mode, but the MCB is operated through the LS5.</p> <p>This application mode provides the following functions:</p> <ul style="list-style-type: none"> ■ Handling of the GCB (dead bus closure, synchronization, open) initiated by start command in AUTO or individually in MAN mode. ■ Handling of the MCB (dead bus closure, synchronization, open) in AUTO and MANUAL according to the rules of the GCB/MCB mode. ■ Measuring and monitoring of generator values (voltage, frequency, phase rotation, current and power) ■ Measuring of generator busbar values (voltage, frequency) ■ Indicating of mains values (voltage, frequency, phase angle) sent from the LS-5. ■ Indicating of active and reactive power at the interchange point sent from LS-5. ■ Regulating Import/Export power with active and reactive power sent from LS-5. ■ Mains voltage and current is usually not connected at the easYgen. ■ The breaker transition mode is considered. ■ Connection to mains (MCB is closed) is recognized via the LS-5. ■ Run-up synchronization, acting on the GCB, is possible.
GCB/GGB/L-MCB		L-MCB		<p>One or more easYgen, one generator group breaker (GGB) in combination with one LS-5 unit, acting on the MCB in a fixed application. Multiple isolated and/or mains parallel operation. The same handling as in the GCB/GGB/MCB mode, but the MCB is operated through the LS-5.</p> <p>This application mode provides the following functions:</p> <ul style="list-style-type: none"> ■ Handling of the GCB (dead bus closure, synchronization, open) initiated by start command in AUTO or individually in MAN mode. ■ Handling of the GGB (dead bus closure, synchronization, open) initiated by start command in AUTO or individually in MAN mode. ■ Handling of the MCB (dead bus closure, synchronization, open) in AUTO and MANUAL according to the rules of the GCB/GGB/MCB mode. ■ Measuring and monitoring of generator values (voltage, frequency, phase rotation, current and power). ■ Measuring of generator busbar values (voltage, frequency). ■ Measuring and monitoring of load busbar values (voltage, frequency, phase rotation, current and power) ■ Indicating of mains values (voltage, frequency, phase angle) sent from the LS-5. ■ Indicating of active and reactive power at the interchange point sent from LS-5. ■ Regulating Import/Export power with active and reactive power sent from LS-5. ■ Run-up synchronization, acting on the GCB or GCB/GGB, is possible. ■ The breaker transition mode is considered. ■ Connection to mains (MCB is closed) is recognized via the LS-5.

easYgen-3400/3500 or easYgen-3400XT/3500XT		LS-511/LS-521		
Mode	Symbol	Mode	Symbol	Function
GCB/L-GGB		L-GGB		<p>One or more easYgen with one LS-5 unit, acting on the GGB in a fixed application. Only isolated operation. The same handling as in the GCB/GGB mode without mains parallel operation, but the GGB is operated through the LS-5.</p> <p>This application mode provides the following functions:</p> <ul style="list-style-type: none"> ■ Handling of the GCB (dead bus closure, synchronization, open) initiated by start command in AUTO or individually in MAN mode. ■ Handling of the GGB (dead bus closure, synchronization, open) initiated by start command in AUTO or individually in MAN mode according to the rules of the GCB/GGB mode. ■ Measuring and monitoring of generator values (voltage, frequency, phase rotation, current and power). ■ Measuring of generator busbar values (voltage, frequency). ■ Run-up synchronization, acting on the GCB or GCB/GGB, is possible.
GCB/L-GGB/L-MCB		L-MCB		<p>One or more easYgen with one LS-5 unit, acting on the GGB and another LS-5 unit, acting on the MCB in a fixed application. Multiple isolated and/or mains parallel operation. The same handling as in the GCB/GGB/MCB mode, but the GGB and MCB are operated by the LS-5.</p> <p>This application mode provides the following functions:</p> <ul style="list-style-type: none"> ■ Handling of the GCB (dead bus closure, synchronization, open) initiated by start command in AUTO or individually in MAN mode. ■ Handling of the GGB (dead bus closure, synchronization, open) initiated by start command in AUTO or individually in MAN mode according to the rule of the GCB/GGB/MCB mode. ■ Handling of the MCB (dead bus closure, synchronization, open) in AUTO and MANUAL according to the rules of the GCB/GGB/MCB mode. ■ Measuring and monitoring of generator values (voltage, frequency, phase rotation, current and power). ■ Measuring of generator busbar values (voltage, frequency) ■ Indicating of mains values (voltage, frequency, phase angle) sent from the LS-5. ■ Indicating of active and reactive power at the interchange point sent from LS-5. ■ Regulating Import/Export power with active and reactive power sent from LS-5. ■ Run-up synchronization, acting on the GCB or GCB/GGB, is possible.
		L-GGB		

6.2 Setup Stand-Alone Applications (Mode A01)

Overview

The LS-5, configured to application mode  ("Single LS-5"), runs as an independent unit and does not expect any other unit on the CAN bus.

The idea of this mode is to use the LS-5 as a simple sync check relay controlled by discrete inputs or to run it together with a PLC as a synchronizer. The PLC receives all measurement values (voltages, current, power, phase angle) via communication interface to run closed loop synchronization.

Additionally the LS-5 can be used as a measurement transformer for displaying and monitoring values. The decoupling functions (voltage, frequency, change of frequency) can also be used when a parallel mains setup exists.

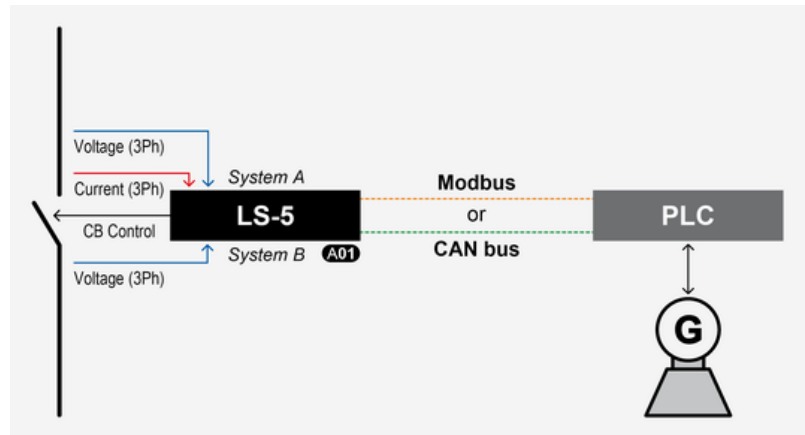

Fig. 122: Application mode

General notes



NOTICE!

Dead bus interlocking due to incorrect setup

No other LS-5 or easYgen device is expected on the CAN bus. After power-up the LS-5 can carry out a dead bus closure regardless if other devices are connected to the bus (arbitration time is ignored).

Nevertheless, dead bus interlocking occurs, if the LS-5 detects another device (with higher priority) within 40 seconds after power-up on the CAN bus, which wants to carry out a dead bus closure.



The LS-5 acts as if there is no other LS-5 in the system.

Prerequisites

Personnel: Qualified electrician

Ensure the following prerequisites are met:

1. For a mains decoupling function, connect the system A measurement on the mains busbar.
2. Setup the PLC to act as master and to monitor the functionality of the communication interface.

Configure LS-5

Personnel: User

Configure the following parameters:



The following paths are valid for the configuration via HMI. At the configuration via ToolKit the path hierarchy might be different.

1. ➤ Set the application mode (parameter 8840 ↗ p. 120) of the LS-5 device to **000**.
2. ➤ To configure measurement navigate to “*Parameter* ➔ *Configuration* ➔ *Measurement config.*” and enter the desired settings.

3. ➤



When tapping voltages over power transformer, phase angle compensation may be required.

If a phase angle compensation is required, navigate to “*Configuration* ➔ *Application config.* ➔ *Breakers config.* ➔ *Synchronization config.* ➔ *Phase angle compensation*”



NOTICE!
Component damage

Incorrect settings may cause erratic system behavior and damage to the involved components .

- Set the values carefully and double check with a voltmeter at the according breaker.

4. ➤ If control to open and close the breaker should be handled by discrete inputs, use the default setting according to the wiring diagram (↗ *Chapter 3.3.2 “Wiring Diagram” on page 37*).
5. ➤ If control to open and close the breaker should be handled by communication interface, the register with the remote control bits is used (LM Command variables 04.44 to 04.59, Bit 1 to Bit 16).

For more information on how to address the according data register refer to ↗ *Chapter 7 “Interfaces And Protocols” on page 257*.

6. ➤ Configure the breaker close command
 - To configure the close command CBA, the Logics-Manager equation "Enable close CBA" can be modified. Navigate to “*Configuration* ➔ *Application config.* ➔ *Breakers config.* ➔ *Configure CBA* ➔ *Enable close CBA*” and enter the desired arguments.

7. ➤ Configure the breaker open command

- To configure the open command CBA, the Logics-Manager equation "Open CBA immed." can be modified. Navigate to "Configuration ➔ Application config. ➔ Breakers config. ➔ Configure CBA ➔ Open CBA immed." and enter the desired arguments.



The open command can only be executed through the LogicsManager equation "Open CBA unload", if the PLC can influence the unloading of the breaker.

8. ➤ If manual operation via push buttons acting on DI is required

- For the CBA the two LogicsManager equations "Open CBA in manual" and "Close CBA in manual" can be used. Set the parameter "Open CBA in manual" to "Immediate".

9. ➤ The LS-5 can be adjusted for different kinds of breaker closure.

Navigate to "Configuration ➔ Application config. ➔ Breakers config. ➔ Configure CBA" to configure specific kinds of breaker closure.

Configure "Dead bus closure CBA" to generally handle any kind of dead busbar closure.

6.3 Setup easYgen & Slave LS-5 Applications (Mode A03 & A04)

6.3.1 Introduction

In application modes **A03** and **A04** the LS-5 runs as a slave unit. In these modes the LS-5 is guided by the easYgen and takes over directly the close and open commands coming from the easYgen(s).

No external logic is needed to decide, when the breaker is to open or to close. The operating mode MANUAL in the LS-5 is not supported.

Manual control is provided by the easYgen(s). The isolation switch input of the LS-5 is ignored. The LS-5 sends measuring values and flags to the CAN bus connected easYgen(s), which are needed for the according application mode.

The application mode determines the fixed segment numbers for system A and B. The LogicsManager for close and open commands are faded out.

General notes



*The applications where the LS-5 is configured to **A03** and **A04** are fixed and can not be varied except for the number of generators, feeding on the generator busbar (max. 32). Other tie-breakers are not allowed.*



The LS-5 is expecting at least one easYgen device in the system.



Complex applications may require external close and open logic (via PLC).



*In application mode **A03** and **A04** the operating mode MANUAL is not supported in the LS-5.*

Predefined applications

The following chapters provide step by step instructions on how to set up the following predefined applications:

- [↪ Chapter 6.3.2 “Single Or Multiple easYgen With One Externally Operated MCB” on page 198](#)
- [↪ Chapter 6.3.3 “Multiple easYgen With One GGB And One Externally Operated MCB” on page 202](#)
- [↪ Chapter 6.3.4 “Multiple easYgen With One Externally Operated GGB In Isolated Operation” on page 207](#)
- [↪ Chapter 6.3.5 “Multiple easYgen With One Externally Operated GGB And One Externally Operated MCB” on page 210](#)

6.3.2 Single Or Multiple easYgen With One Externally Operated MCB

Overview

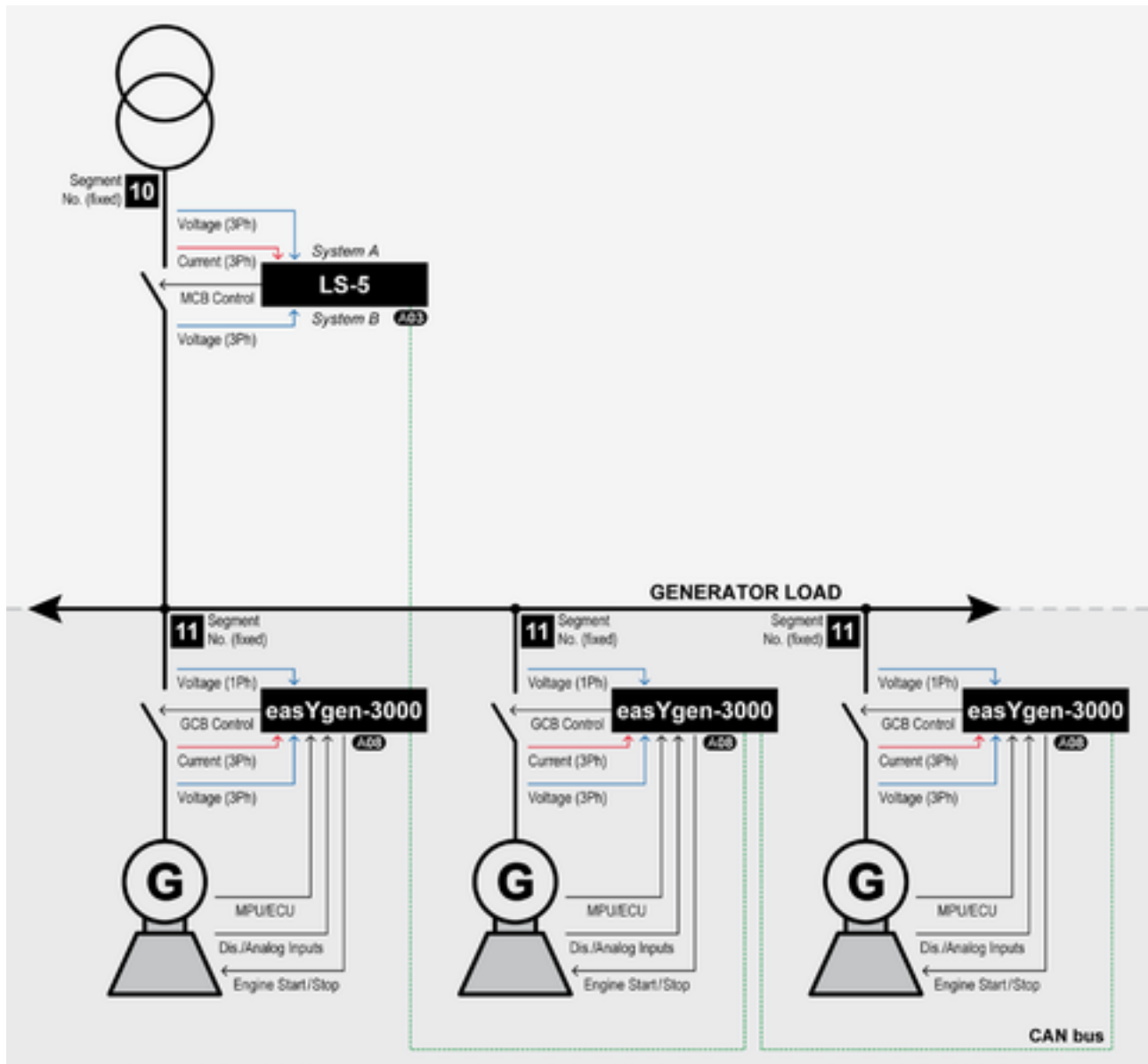

Fig. 123: Single or multiple easYgen with one externally operated MCB

One or more gensets feed on a load busbar. The easYgen(s) close and open their own generator breaker. The LS-5 at the interchange point closes and opens the MCB. All breakers are connected to the same segment; the generator busbar is equal to the load busbar. The easYgen(s) are running the same tasks as in the application mode GCB/MCB with the differentiation, that instead of a direct MCB handling now the LS-5 is taking over that part.

The decision when to close or open the MCB is coming from the easYgen(s) via CAN bus. The manual control on the MCB is restricted on the easYgen(s). If a run-up synchronization is desired, only the mode "with GCB" is supported.

In this setup the mains decoupling is provided by the LS-5.

Required application modes:

- easYgen-3400/3500 or easYgen-3400XT/3500XT: **A0B**
- LS-5: **A0B**

General notes

To provide mains decoupling, acting on the GCB, the mains decoupling function of the easYgen must be used.

- *Refer to the corresponding chapter of the easYgen manual.*



This application setup is predefined and allows for no variations, except the amount of easYgen-3000 or easYgen-3000XT driven generators (up to 32).

- *Check whether your application is compatible with the prerequisites listed below.*

Prerequisites LS-5

Personnel: ■ Qualified electrician

Ensure the following prerequisites are met:

1. The system A voltage and current measurement is connected to the mains.
2. The system B voltage measurement is connected to the busbar.
3. The MCB breaker feedback is connected to the LS-5 only.
4. The MCB breaker command(s) are connected to the LS-5 only.
5. The LS-5 CAN bus is connected to the CAN bus #3 of the easYgen(s).

Prerequisites easYgen

Personnel: ■ Qualified electrician



Ensure the following prerequisites are met:

1. The generator voltage and current measurement is connected to the generator.
2. The busbar voltage measurement is connected to the busbar.
3. The mains voltage measurement is not used.
4. The GCB breaker feedback is connected to the according easYgen.
5. The GCB breaker command(s) are connected to the according easYgen.
6. The easYgen CAN bus #3 is connected to the CAN bus of the LS-5.

Configure LS-5

Personnel: User

Configure the following parameters:

1.  Configure the application mode (parameter 8840  p. 120) of the LS-5 device to .

2.  Configure the measurement system A and B.

3. 



When tapping voltages over power transformer, phase angle compensation may be required.

If a phase angle compensation is required, navigate to “*Configuration* → *Application config* → *Breakers config.* → *Configure CBA* → *Synchronization CBA* → *Phase angle compensation*”



NOTICE!
Component damage

Incorrect settings may cause erratic system behavior and damage to the involved components .

- Set the values carefully and double check with a voltmeter at the according breaker.



4.  Configure the breaker close and/or open relay(s) according to your MCB.

5.  Check the synchronization setting, like phase angle, frequency window and voltage.

Configure easYgen

Personnel: User

Configure the following parameters:

1.  Configure the application mode (parameter 3444) of each easYgen device to .

2.  Configure the measurement for generator and busbar according to the easYgen manual.

3. The mains measurement is not used in this application mode. A couple of settings should be configured as follows.

- Switch off the following parameters:

Parameter	ID
Mains decoupling	3110
Change of frequency	3058
Overfrequency level 1	2850
Underfrequency level 1	2900
Overfrequency level 2	2856
Underfrequency level 2	2906
Overvoltage level 1	2950
Undervoltage level 1	3000
Overvoltage level 2	2956
Undervoltage level 2	3006
Mains voltage increase	8806

- 4.



When tapping voltages over power transformer, phase angle compensation may be required.

If a phase angle compensation is required, navigate to *"Parameter → Configuration → Configure Application → Configure Breakers → Configure GCB → Phase angle compensation GCB"*.



NOTICE!
Component damage

Incorrect settings may cause erratic system behavior and damage to the involved components .

- Set the values carefully and double check with a voltmeter at the according breaker.

5. For displaying the mains values coming from LS-5 on the main screen, navigate to parameter "Show mains data" (parameter 4103) and switch to "LS5".

- 6.



In this setup each easYgen device provides four control bits for sending information to the LS-5. These bits can be used as command variables in the LS-5.

One of the bits could for example be used to initiate alarms acknowledgement in the LS-5 or to release the mains decoupling.

Navigate to *"Parameter → Configuration → Configure LogicsManager → Configure LS5"* to configure the command variables.

6.3.3 Multiple easYgen With One GGB And One Externally Operated MCB

Overview

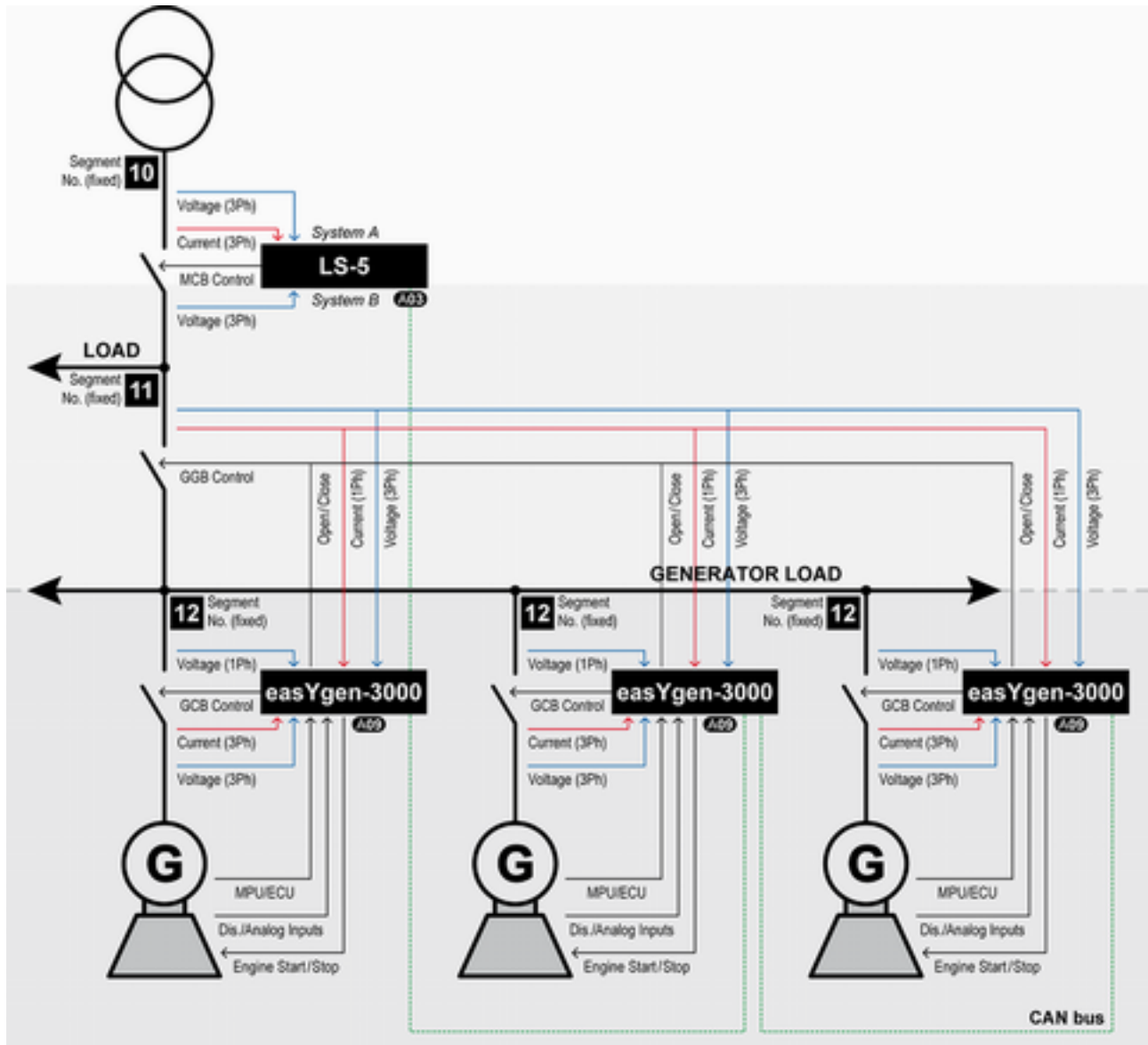

Fig. 124: Multiple easYgen with one GGB and one externally operated MCB



One or more gensets feed on a generator busbar. The easYgen(s) close and open their own generator breaker. The easYgen(s) close and open the common generator group breaker (GGB). The LS-5 at the interchange point closes and opens the MCB.

This application includes a generator busbar and a load busbar and one mains income. The easYgen(s) running the same tasks as in the application mode GCB/GGB/MCB with the differentiation, that instead of a direct MCB handling through the easYgen, the LS-5 controls the MCB.

The decision when to close or open the MCB is coming from the easYgen(s) over the CAN bus. The manual control on the MCB is restricted on the easYgen(s).

If a run-up synchronization is desired, the modes "with GCB" and "with GCB/GGB" are supported. In this setup the mains decoupling is provided by the LS-5.

Required application modes:

- easYgen-3400/3500 or easYgen-3400XT/3500XT: 
- LS-5: 

General notes



For information on mains decoupling over GCB refer to the corresponding chapter of the easYgen manual.



The mains measurement of the easYgen(s) are used for the load busbar measurement.







This application setup is predefined and allows for no variations, except the amount of easYgen-3000 or easYgen-3000XT driven generators (up to 32).

- *Check whether your application is compatible with the prerequisites listed below.*

Prerequisites LS-5

Personnel: ■ Qualified electrician





Ensure the following prerequisites are met:

1.  The system A voltage and current measurement is connected to the mains.
2.  The system B voltage measurement is connected to the load busbar.
3.  The MCB breaker feedback is connected to the LS-5 only.
4.  The MCB breaker command(s) are connected to the LS-5 only.
5.  The LS-5 CAN bus is connected to the CAN bus #3 of the easYgen(s).

Prerequisites easYgen

Personnel: ■ Qualified electrician

Ensure the following prerequisites are met:

1.  The generator voltage and current measurement is connected to the generator.
2.  The busbar voltage measurement is connected to the generator busbar.
3.  The mains voltage measurement is connected to the load busbar.
4.  The GGB breaker feedback is connected to all easYgens.
5.  The GGB breaker command(s) are connected to all easYgens.

6. ➤ The GCB breaker feedback is connected to the according easYgen.
7. ➤ The GCB breaker command(s) are connected to the according easYgen.
8. ➤ The easYgen CAN bus #3 is connected to the CAN bus of the LS-5.

Configure LS-5

Personnel: User

Configure the following parameters:

1. ➤ Configure the application mode (parameter 8840 ↪ p. 120) of the LS-5 device to **400**.
2. ➤ Configure the measurement system A and B.

3. ➤



When tapping voltages over power transformer, phase angle compensation may be required.

If a phase angle compensation is required, navigate to
"Configuration → Application config → Breakers config.
→ Configure CBA → Synchronization CBA
→ Phase angle compensation"



NOTICE! **Component damage**

Incorrect settings may cause erratic system behavior and damage to the involved components .

- Set the values carefully and double check with a voltmeter at the according breaker.

4. ➤ Configure the breaker close and/or open relay(s) according to your MCB.
5. ➤ Check the synchronization settings, like phase angle, frequency window and voltage.

Configure easYgen

Personnel: User

Configure the following parameters:

1. ➤ Configure the application mode (parameter 3444) of each easYgen device to **400**.
2. ➤ Configure the measurement for generator and busbar according to the easYgen manual.

3. ➤ Configure the mains measurement according to the easYgen manual, but in relation to the load busbar voltage.

The mains measurement of the easYgen is only taken for synchronization GGB, operating range consideration and phase rotation check.

All other easYgen mains measurement functions are not used. A couple of settings should be configured as follows.

- Switch off the following parameters:

Parameter	ID
Mains decoupling	3110
Change of frequency	3058
Overfrequency level 1	2850
Underfrequency level 1	2900
Overfrequency level 2	2856
Underfrequency level 2	2906
Overvoltage level 1	2950
Undervoltage level 1	3000
Overvoltage level 2	2956
Undervoltage level 2	3006
Mains voltage increase	8806

4. ➤



When tapping voltages over power transformer, phase angle compensation may be required.

If a phase angle compensation over the GCB is required, navigate to “Parameter → Configuration → Configure Application → Configure Breakers → Configure GCB → Phase angle compensation GCB”.



NOTICE!
Component damage

Incorrect settings may cause erratic system behavior and damage to the involved components.

- Set the values carefully and double check with a voltmeter at the according breaker.

5. ➤ If a phase angle compensation over the GGB is required, navigate to "MCB phase angle compensation" in ToolKit.



NOTICE!

Component damage

Incorrect settings may cause erratic system behavior and damage to the involved components .

- Set the values carefully and double check with a voltmeter at the according breaker.

6. ➤ To display the mains values coming from LS-5 on the main screen, navigate to "Show mains data" (parameter 4103) and switch to "LS5".

7. ➤



In this setup each easYgen device provides four control bits for sending information to the LS-5. These bits can be used as command variables in the LS-5.

One of the bits could for example be used to initiate alarms acknowledgement in the LS-5.

Navigate to "Parameter ➔ Configuration ➔ Configure LogicsManager ➔ Configure LS5" to configure the command variables.

6.3.4 Multiple easYgen With One Externally Operated GGB In Isolated Operation

Overview

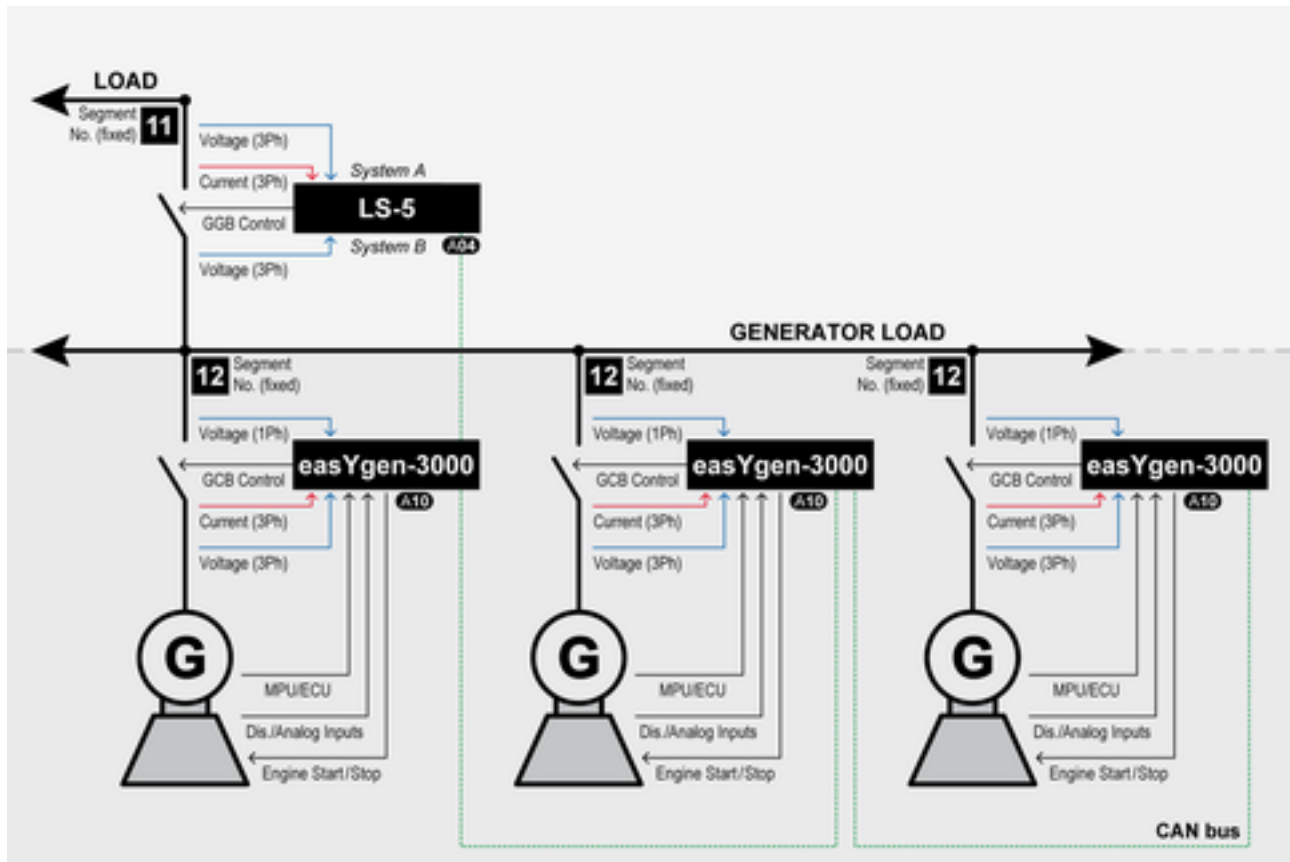



Fig. 125: Multiple easYgen with one externally operated GGB in isolated operation

One or more gensets feed on a generator busbar. The easYgen(s) close and open their own generator breaker. The easYgens close and open the common generator group breaker (GGB). The LS-5 over the GGB closes and opens the GGB.

This application includes a generator busbar and a load busbar. The mains is not present. The easYgen(s) running the same tasks as in the application mode GCB/GGB with the differentiation that only isolated operation is allowed and instead of a direct GGB handling through the easYgen, the LS-5 controls the GGB.

The decision when to close or open the GGB is coming from the easYgen(s) over the CAN bus. The manual control on the GGB is restricted on the easYgen(s). If a run-up synchronization is desired, the modes "with GCB" and "with GCB/GGB" are supported.

Required application modes:

- easYgen-3400/3500 or easYgen-3400XT/3500XT: 
- LS-5: 

General notes



This application setup is predefined and allows for no variations, except the amount of easYgen-3000 or easYgen-3000XT driven generators (up to 32).

- *Check whether your application is compatible with the prerequisites listed below.*

Prerequisites LS-5

Personnel: ■ Qualified electrician

Ensure the following prerequisites are met:

1. ► The system A voltage measurement is connected to the load busbar.
2. ► The system B voltage measurement is connected to the generator busbar.
3. ► The GGB breaker feedback is connected to the LS-5 only.
4. ► The GGB breaker command(s) are connected to the LS-5 only.
5. ► The LS-5 CAN bus is connected to the CAN bus #3 of the easYgen(s).

Prerequisites easYgen

Personnel: ■ Qualified electrician

Ensure the following prerequisites are met:

1. ► The generator voltage and current measurement is connected to the generator.
2. ► The busbar voltage measurement is connected to the busbar.
3. ► The mains voltage measurement is not used.
4. ► The GCB breaker feedback is connected to the according easYgen.
5. ► The GCB breaker command(s) are connected to the according easYgen.
6. ► The easYgen CAN bus #3 is connected to the CAN bus of the LS-5.

Configure LS-5

Personnel: ■ User

Configure the following parameters:

1. ► Configure the application mode (parameter 8840 ↗ p. 120) of the LS-5 device to **400**.
2. ► Configure the measurement system A and B.
3. ► Configure the breaker close and/or open relay(s) according to your GGB.

Configure easYgen

Personnel: ■ User

Configure the following parameters:

1. ► Configure the application mode (parameter 3444) of each easYgen device to **410**.
2. ► Configure the measurement for generator and busbar according to the easYgen manual.

3. The mains measurement is not used in this application mode. A couple of settings should be configured as follows.

- Switch off the following parameters:

Parameter	ID
Mains decoupling	3110
Change of frequency	3058
Overfrequency level 1	2850
Underfrequency level 1	2900
Overfrequency level 2	2856
Underfrequency level 2	2906
Overvoltage level 1	2950
Undervoltage level 1	3000
Overvoltage level 2	2956
Undervoltage level 2	3006
Mains voltage increase	8806

- 4.



When tapping voltages over power transformer, phase angle compensation may be required.

If a phase angle compensation over the GCB is required, navigate to “Parameter → Configuration → Configure Application → Configure Breakers → Configure GCB → Phase angle compensation GCB”.



NOTICE!
Component damage

Incorrect settings may cause erratic system behavior and damage to the involved components .

- Set the values carefully and double check with a voltmeter at the according breaker.

- 5.



In this setup each easYgen device provides four control bits for sending information to the LS-5. These bits can be used as command variables in the LS-5.

One of the bits could for example be used to initiate alarms acknowledgement in the LS-5.

Navigate to “Parameter → Configuration → Configure LogicsManager → Configure LS5” to configure the command variables.

6.3.5 Multiple easYgen With One Externally Operated GGB And One Externally Operated MCB

Overview

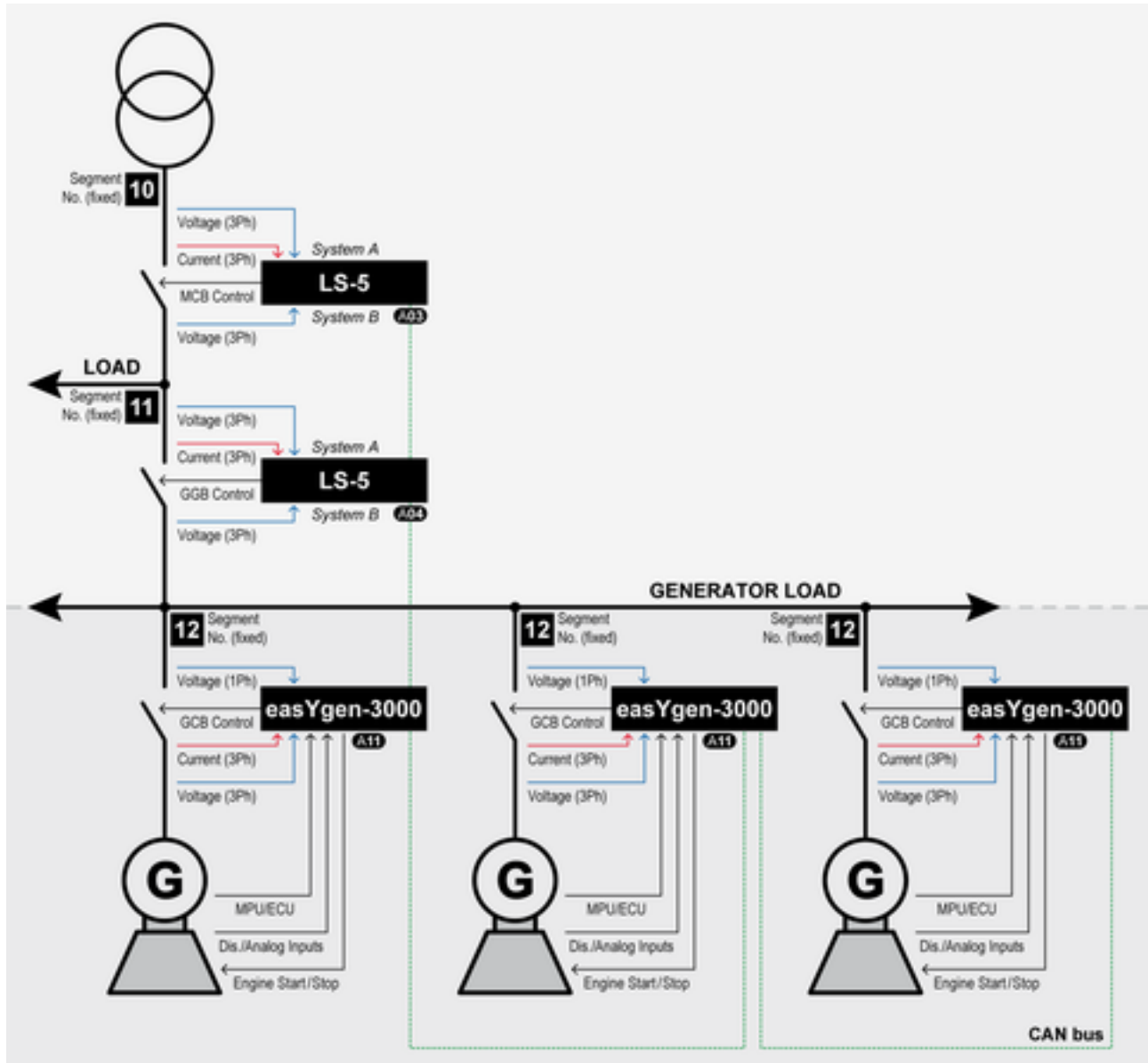





Fig. 126: Multiple easYgen with one externally operated GGB and one externally operated MCB

One or more gensets feed on a generator busbar. The easYgen(s) close and open their own generator breaker. The LS-5 between the generator busbar and load busbar close and open the common generator group breaker (GGB). The LS-5 at the interchange point to the mains closes and opens the MCB.

This application includes a generator busbar, a load busbar and one mains income. The easYgen(s) running the same tasks as in the application mode GCB/GGB/MCB with the differentiation, that instead of a direct GGB and MCB handling through the easYgen, the both LS-5 devices take over that part.

The decision when to close or open the MCB and GGB is coming from the easYgen(s) over the CAN bus. The manual control on the MCB and GGB is restricted on the easYgen(s). If a run-up synchronization is desired, the modes "with GCB" and "with GCB/GGB" are supported. In this setup the mains decoupling is provided by the LS-5.

Required application modes:

- easYgen-3400/3500 or easYgen-3400XT/3500XT: 
- LS-5: 
- LS-5: 

General notes



If mains decoupling over GCB is required, refer to the corresponding chapter of the easYgen manual.







This application setup is predefined and allows for no variations, except the amount of easYgen-3000 or easYgen-3000XT driven generators (up to 32).

- *Check whether your application is compatible with the prerequisites listed below.*

Prerequisites LS-5 (MCB)

Personnel: ■ Qualified electrician





Ensure the following prerequisites are met:

1.  The system A voltage and current measurement is connected to the mains.
2.  The system B voltage measurement is connected to the load busbar.
3.  The MCB breaker feedback is connected to the LS-5 only.
4.  The MCB breaker command(s) are connected to the LS-5 only.
5.  The LS-5 CAN bus is connected to the CAN bus #3 of the easYgen(s).

Prerequisites LS-5 (GGB)

Personnel: ■ Qualified electrician

Ensure the following prerequisites are met:

1.  The system A voltage measurement is connected to the load busbar.
2.  The system B voltage measurement is connected to the generator busbar.
3.  The GGB breaker feedback is connected to the LS-5 only.
4.  The GGB breaker command(s) are connected to the LS-5 only.
5.  The LS-5 CAN bus is connected to the CAN bus #3 of the easYgen(s).

Prerequisites easYgen

Personnel: ■ Qualified electrician

Ensure the following prerequisites are met:

1. ➤ The generator voltage and current measurement is connected to the generator.
2. ➤ The busbar voltage measurement is connected to the generator busbar.
3. ➤ The mains voltage measurement is not used.
4. ➤ The GCB breaker feedback is connected to the according easYgen.
5. ➤ The GCB breaker command(s) are connected to the according easYgen.
6. ➤ The easYgen CAN bus #3 is connected to the CAN bus of the LS-5.

Configure LS-5 (MCB)

Personnel: ■ User

Configure the following parameters:

1. ➤ Configure the application mode (parameter 8840 ↗ p. 120) of the LS-5 device to **#03**.
2. ➤ Configure the measurement system A and B.

3. ➤



When tapping voltages over power transformer, phase angle compensation may be required.

If a phase angle compensation over the GCB is required, navigate to “*Configuration* → *Application config* → *Breakers config*. → *Configure CBA* → *Synchronization CBA* → *Phase angle compensation*”



NOTICE! **Component damage**

Incorrect settings may cause erratic system behavior and damage to the involved components .

- Set the values carefully and double check with a voltmeter at the according breaker.

4. ➤ Configure the breaker close and/or open relay(s) according to your MCB.
5. ➤ Check the synchronization setting, like phase angle, frequency window and voltage.

Configure LS-5 (GGB)

Personnel: User

Configure the following parameters:

1. ➤ Configure the application mode (parameter 8840 ↗ p. 120) of the LS-5 device to **400**.
2. ➤ Configure the measurement system A and B.

3. ➤



When tapping voltages over power transformer, phase angle compensation may be required.

If a phase angle compensation over the GCB is required, navigate to “Parameter → Configuration → Configure Application → Configure Breakers → Configure GCB → Phase angle compensation GCB”.



NOTICE! **Component damage**

Incorrect settings may cause erratic system behavior and damage to the involved components .

- Set the values carefully and double check with a voltmeter at the according breaker.

4. ➤ Configure the breaker close and/or open relay(s) according to your GGB.
5. ➤ Check the synchronization setting, like phase angle, frequency window and voltage.

Configure easYgen

Personnel: User

Configure the following parameters:

1. ➤ Configure the application mode (parameter 3444) of each easYgen device to **411**.
2. ➤ Configure the measurement for generator and busbar according to the easYgen manual.

3. The mains measurement is not used in this application mode. A couple of settings should be configured as follows.

Switch off the following parameters:

Parameter	ID
Mains decoupling	3110
Change of frequency	3058
Overfrequency level 1	2850
Underfrequency level 1	2900
Overfrequency level 2	2856
Underfrequency level 2	2906
Overvoltage level 1	2950
Undervoltage level 1	3000
Overvoltage level 2	2956
Undervoltage level 2	3006
Mains voltage increase	8806

4.



When tapping voltages over power transformer, phase angle compensation may be required.

If a phase angle compensation over the GCB is required, navigate to *“Parameter → Configuration → Configure Application → Configure Breakers → Configure GCB → Phase angle compensation GCB”*.



NOTICE!
Component damage

Incorrect settings may cause erratic system behavior and damage to the involved components .

- Set the values carefully and double check with a voltmeter at the according breaker.

5. To display the mains values coming from LS-5 on the main screen, navigate to *“Show mains data”* (parameter 4103) and switch to *“LS5”*.

6.



In this setup each easYgen device provides two control bits for sending information to the LS-5. These bits can be used as command variables in the LS-5.

One of the bits could for example be used to initiate alarms acknowledgement in the LS-5 or to release the mains decoupling.

Navigate to *“Parameter → Configuration → Configure LogicsManager → Configure LS5”* to configure the command variables.

6.4 Setup easYgen & Independent LS-5 Applications (Mode A02)

6.4.1 Introduction

In application mode **A02** ('LS5') the LS-5 runs as an independent unit. The free LS-5 setup allows up to 32 easYgen-3400/3500 or easYgen-3400XT/3500XT and up to 16 LS-5 devices. The easYgen(s) are only operating their GCBs. The other breakers have to be operated by the LS-5.

The closing and opening of the breaker is controlled through the LogicsManager equations "Open CBA unload", "Open CBA immed." and "Enable close CBA".

The close and open commands are configured with Logics-Manager command variables. This can be discrete inputs, remote control flags or flags coming from easYgen(s) or other LS-5(s).

The operating mode MANUAL in the LS-5 is supported and provides the operator with the option to manually force a close or open of the breaker. For this purpose the LS-5 provides an operating mode button and a softkey to close and open the breaker.



The band width of the CAN bus allows to connect up to 32 easYgens in conjunction with up to 16 LS-5 devices. This is always guaranteed. In particular cases it could be desired to run more than 16 LS-5 devices. Theoretically up to 32 LS-5 are possible, but it requires in return a reduced number of easYgen devices. A rule of thumb is that the total amount of easYgens and LS-5s shall never expire 48 devices. To be on the safe side please discuss the possible risks with the Woodward Sales Support.

General notes



The LS-5 is expecting at least one easYgen device in the system.



Depending on the complexity of the system equally complex external program logics may be required.



*The LS-5 application mode **A02** opens a wide range of applications and requires more effort to configure the whole easYgen – LS-5 system.*

The sections below explain some of the terms and concepts required in understanding these more complex applications.

Segment number	<p>A segment is defined as a section of the bus, feeder or interconnection, which cannot electrically be isolated to a smaller section and is connected to a circuit breaker or an isolation switch which is operated or supervised by an LS-5.</p> <p>A transformer is not considered as a segment or a point of isolation. Each segment, feeder, or interconnection must be assigned a number that is unique to that segment.</p>
Isolation switch	<p>Some applications include existing isolation switches. An isolation switch is usually taken to interrupt two bars from each other. The breaker is usually controlled manually.</p> <p>The LS-5 unit in application mode 402 can handle max.1 isolation switch. Located at the isolation switch, the LS-5 must be informed about the condition of that switch. The condition determines the segmenting.</p>
Mains breaker	<p>The frequency and voltage are solid. A segment number is needed. The first breaker on the mains side is the MCB.</p> <p>The LS-5 is always connected with measurement system A on the mains side. The setting "Mains connection" is always set on "System A". The system A measurement gets the mains segment number.</p>
Tie-breaker	<p>In this setup there is no direct mains connection neither on system A or system B. For both sides a segment number is needed.</p> <p>There is no clear rule for where system A or system B needs to be connected. Likely the location of the CT determines the measurement A B. The setting "Mains connection" is always set to "None".</p>
Generator	<p>The frequency and voltage are variable. A segment number is not needed.</p>
Device number (control number)	<p>All connected control units must be configured with a unique device number (control number). Hence the units are clear defined in their function and location.</p> <p>The numbers 1 to 32 are reserved for the easYgen(s) (easYgen "Device number"), the numbers 33 to 64 are reserved for the LS-5 (parameter 1702 ↪ p. 73).</p>
CAN bus Node-ID number	<p>To communicate via the CAN bus it is necessary to configure all connected controls with a unique CAN bus Node-ID number (parameter 8950 ↪ p. 138). Usually the same number like the device ID number is taken.</p>
Priority during breaker closure	<p>In an emergency application the simultaneous closing of two circuit breakers is blocked via communications between the LS-5 and the easYgen. Once an easYgen is enabled for a dead bus connection, it has priority over all LS-5s (any CB controlled by an LS-5 cannot be closed).</p> <p>If multiple LS-5s are enabled to close a circuit breaker at the same time the LS-5 with the lowest CAN identification number receives the master status (all other LS-5s are inactive).</p>

When a closure failure occurs (↪ *Chapter 4.4.2 "Breakers" on page 120*), this LS-5 is no longer considered for dead bus closure. The next prioritized LS-5 takes over.

Predefined applications

The following chapters provide step by step instructions on how to set up the following predefined applications:

- ↪ *Chapter 6.4.3 "H-Configuration With Two easYgen And Two Incoming Mains And Tie-breaker" on page 226*
- ↪ *Chapter 6.4.4 "Multiple Mains/Generators With Four easYgen Units, Two Incoming Mains And Different Tie-breakers" on page 236*

6.4.2 General Functions

6.4.2.1 General Preparation

Prepare the easYgen – LS-5 system for configuration as follows:

1. ➤ Draw a single line diagram that only contains essential equipment.
The schematic should contain all used easYgens, all transformers, all breaker elements (such as circuit breakers and isolation switches), all elements to be controlled, and all LS-5s.
2. ➤ Assign numbered addresses for each component of the system in accordance with the methods described in ↪ *Chapter 6.4.1 "Introduction" on page 215*.
3. ➤ Number all easYgen control units from 1 to 32 (order is user-defined and depends on your application).
4. ➤ Number all system LS-5s from 33 to 48 (order is user-defined and depends on your application).
5. ➤ Number all CAN Node-IDs (usually the same as the device number).
6. ➤ Number all segments according to the definitions in ↪ *"Segment number" on page 216*.



Unless special numbering conventions are required, count up continuously from left to right or right to left.

7. ➤ Draw the measurement system A and B of the single LS-5 into the single line diagram according to the definitions in ↪ *Chapter 6.4.1 "Introduction" on page 215*.

Keep system A and B on the same side. This simplifies the configuration. The location of a CT may force you to ignore this rule but this can be compensated for in the configuration.

6.4.2.2 Setup Mains Measurement With easYgen

Overview

In easYgen application mode  ('GCB/LS5') mains measurement of the easYgen is not required. This measurement is provided by the LS-5 unit.



Exception: mains decoupling acting on GCB

When using the mains decoupling function the mains measurement of the easYgen is required.

- For information on this setup refer to [Chapter 6.4.2.3 "Setup Mains Decoupling With easYgen"](#) on page 218.

Prerequisites easYgen

Personnel: User

➔ The application uses the easYgen in mode **A07** (configured in parameter 8840).

Configure easYgen

Personnel: User

To prevent the easYgen measurement from causing alarms, it must be configured as follows.

➔ Switch off the following parameters:

Parameter	ID
Mains decoupling	3110
Change of frequency	3058
Overfrequency level 1	2850
Underfrequency level 1	2900
Overfrequency level 2	2856
Underfrequency level 2	2906
Overvoltage level 1	2950
Undervoltage level 1	3000
Overvoltage level 2	2956
Undervoltage level 2	3006
Mains voltage increase	8806



The mains current and power measurement is never used in the application mode **A07**.

6.4.2.3 Setup Mains Decoupling With easYgen

Overview

To provide mains decoupling, acting on the GCB, the mains decoupling function of the easYgen must be used.

Prerequisites easYgen

Personnel: ■ Qualified electrician

Ensure the following prerequisites are met:

- The mains measurement is connected together with the busbar measurement on the generator busbar.

Configure easYgen



For detailed information on the easYgen configuration, refer to the easYgen-3400/3500 or easYgen-3400XT/3500XT manual.



For matching the VDE-AR-N 4105 requirements, please refer to the 4105 chapters in the easYgen and the LS-5 manual.

6.4.2.4 Setup Mains Decoupling With LS-5

Overview

In this setup the mains decoupling is provided by the LS-5 for the MCB.



When the mains decoupling over GCB is required, refer to ↗ Chapter 6.4.2.3 "Setup Mains Decoupling With easYgen" on page 218.

The LS-5(s) which are responsible for the mains breakers take over the mains monitoring and execute the decoupling function.

Prerequisites LS-5

Personnel: ■ Qualified electrician

Ensure the following prerequisites are met:

1. ➤ The mains monitoring is set up with the measurement system A.
2. ➤ The measurement system A is connected on the mains side.

Configure LS-5

Configure the following parameters:

1. ➤ Navigate to "Configuration → Monitoring config. → System A → Voltage" and configure "SyA. voltage monitoring" (parameter 1771 ↗ p. 79) to "Phase-Phase (Ph-Ph)" or "Phase-Neutral (Ph-N)".
2. ➤ Navigate to "Operating voltage" and configure the operating range for voltage.



Make sure not configure the range smaller than the decoupling threshold (see below).

3. Navigate to "Operating frequency" and configure the operating range for frequency.

i Make sure not configure the range smaller than the decoupling threshold (see below).

4. Configure the mains settling time (parameter 2801 ↘ p. 80).
The mains settling time determines for how long the mains stay continuously stable, before the MCB is closed again.

i Multiple LS-5s on different mains incoming points should have the same setting.

5. Navigate to "SyA. Decoupling" and configure the Logics-Manager equation "Enable SyA dec."

i The following steps show two different configuration examples.

LogicsManager configuration example 1

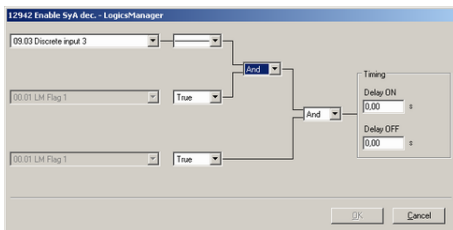

Fig. 127: LogicsManager configuration example 1

6. The mains decoupling function is only enabled, if an external release is given (Discrete Input 3).

i In this case a PLC is required.

LogicsManager configuration example 2

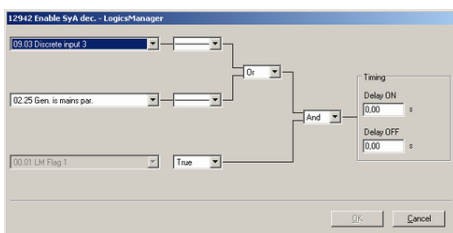

Fig. 128: LogicsManager configuration example 2

7. The mains decoupling function is enabled, if a "Test" key switch is activated.

i This helps to perform a mains decoupling test without any generator running.

OR

The mains decoupling function is enabled, if any generator is running parallel to mains.

8. Configure the corresponding mains decoupling thresholds:

Parameter	ID
Overvoltage level 2	2956
Undervoltage level 2	3006
Overfrequency level 2	2856
Underfrequency level 2	2906
Change of frequency	3058

9. Configure the alarm class and self-acknowledgment.**6.4.2.5 Setup Run-Up Synchronization In LS-5 Mode****Configure easYgen**

The LS-5 mode allows the run-up synchronization only for the GCB. The mode GCB/GGB is not supported.



The easYgen will only close its breaker in a run-up situation, if the LS-5 system detects no connection to mains for the corresponding easYgen segment.

Configure LS-5

Regarding run-up synchronization there is nothing to configure in the LS-5.

6.4.2.6 Setup AMF Start In LS-5 Mode**Overview**

The easYgen(s) can monitor dedicated segments to cause an AMF start in case their voltage or frequency are out of operating range.

This is the procedure for an AMF start:

- 1.** The easYgen(s) monitors the configured segment(s) whether it is in operation range.
- 2.** If minimum one segment is recognized as being out of operating range, the generator starts after the emergency run delay time.
- 3.** After a successful start all generator breakers will be closed.



To avoid that the MCB stays closed during emergency run the according LS-5s must maintain by their own to open their MCBs.

The example below shows a solution where the "System A Not-OK" flag opens the MCB automatically after the emergency delay time.

The system A condition flags are generated out of the operating ranges for system A.

- For additional information refer to [Chapter 6.4.2.3 "Setup Mains Decoupling With easYgen"](#) on page 218.

The easYgen feeds its own segment during emergency run. The AMF mode is only stopped, if all monitored segments are OK for the mains settling time and have reestablished the connection to mains.



The operating ranges and the main settling time are configured in the LS-5s.

Configure LS-5

Personnel: User

Configure the following parameters for the LS-5 unit over the MCB:

1. Navigate to "Configuration → Monitoring config. → System A".
2. Navigate to "Operating voltage / frequency" and configure the operating range for voltage.
3. Navigate to "Operating voltage / frequency" and configure the operating range for frequency.
4. Navigate to "Configuration → Application config. → Breakers config. → Configure CBA" and configure "Open CBA immed." as shown in the screenshot.

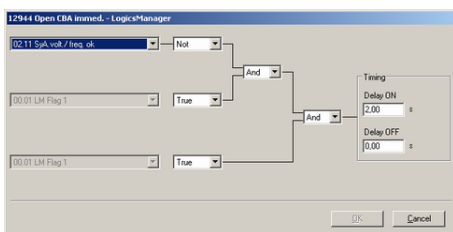

Fig. 129: LogicsManager configuration

LS-5 over the MCB:

- The LS-5 issues an MCB open command, if the mains (system A) is not in operating range.
- To avoid flicker trouble, the open command is delayed.



There may other solutions exist to open the MCB. The LogicsManager system provides a wide range of flags and conditions to take from.

So another example could be to incorporate a flag coming from easYgen, which signals successful start.

Configure easYgen(s)

Personnel: ■ User

Configure the following parameters:

1. ➤ Configure the application mode of the easYgen device to .
2. ➤ Navigate to "Parameter → Configuration → Configure emergency run" and configure "Mains fail delay time", "LM inhibit emerg.run", "Break emerg. in critical mode" according to your application.
3. ➤ Configure the emergency run segments in each easYgen. They can differ between easYgens or easYgen groups.

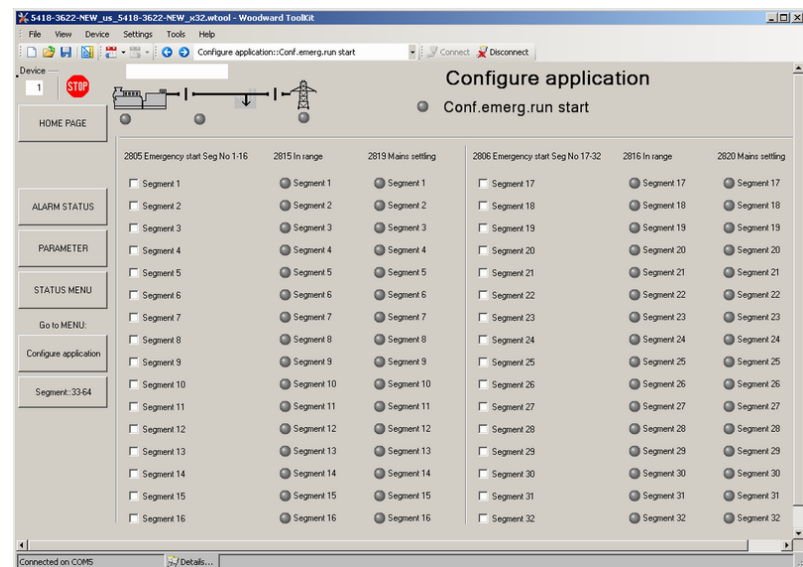

Fig. 130: Segment configuration in ToolKit

- ⇒ The example shows the segment configuration according to [Chapter 6.4.3 "H-Configuration With Two easYgen And Two Incoming Mains And Tie-breaker"](#) on page 226.

6.4.2.7 Setup Manual Breaker Control In LS-5 Mode

Overview

The LS-5 mode provides manual closing and opening of the circuit breaker at the particular LS-5.

This can be configured via LogicsManager equations. The display variant provides additionally soft keys in the display. The soft keys take part of the key lock function for security reasons or unintended operations.



In this mode the easYgen(s) have no direct influence on the manual control of the LS-5(s).

6.4.2.8 Setup LS-5 Command Bits From easYgen To LS-5

Overview

The easYgen provides six LS-5 command bits in this application mode. The command bits are transported via CAN interface to each LS-5.

The design engineer can decide, if he wants to take the OR'ed LS-5 command flags coming from all easYgens or if he wants to take the individual command flag coming from a special easYgen.

In the example an 'acknowledge' alarm command could be a general flag which would be taken from the OR'ed source.

A special close command in the example could come from a specific easYgen and must be therefore not taken from the OR'ed list.

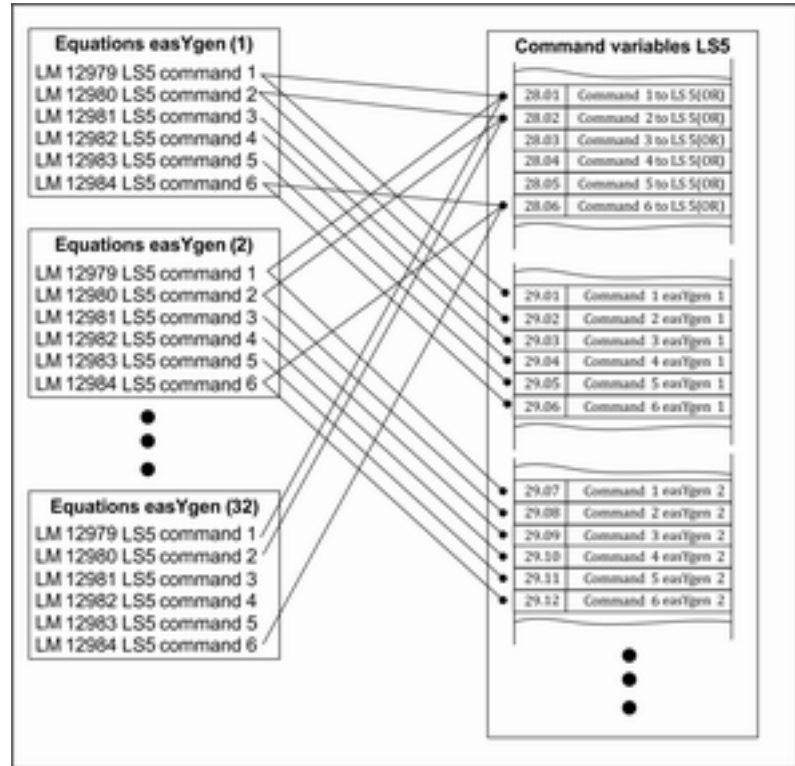

Fig. 131: easYgen information transport to LS-5

6.4.2.9 Setup LS-5 Flags From LS-5 To LS-5 And easYgen

Overview

The LS-5 flags generated in the LS-5 device with LogicsManager equations can be used from connected LS-5 and easYgen devices. Each LS-5 sends five flags over the CAN interface.

The system allows to inform or to command something to other units. In the example the 'acknowledge' command can be sent to all other units to reset alarms. All bits are individual.

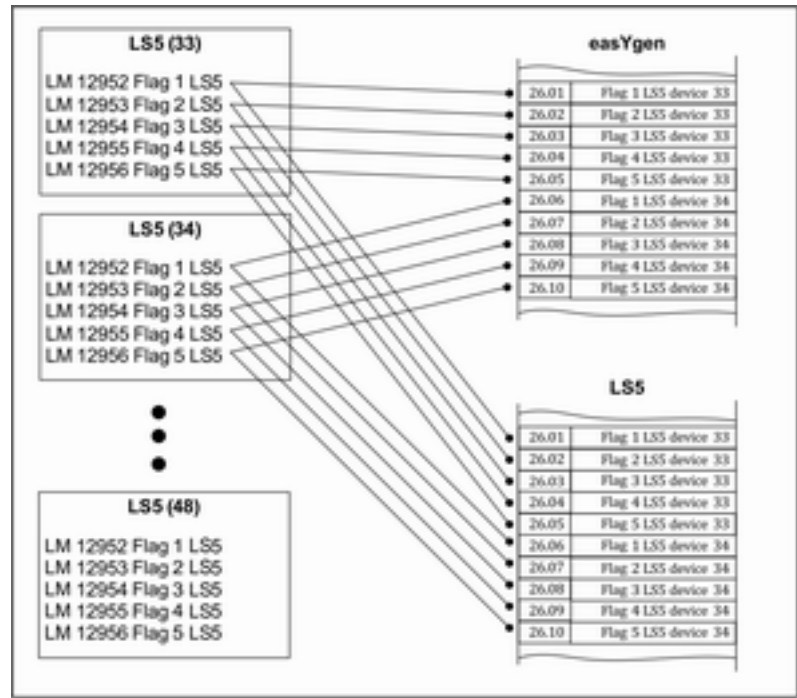

Fig. 132: LS-5 information transport to LS-5 and easYgen

6.4.3 H-Configuration With Two easYgen And Two Incoming Mains And Tie-breaker

Overview

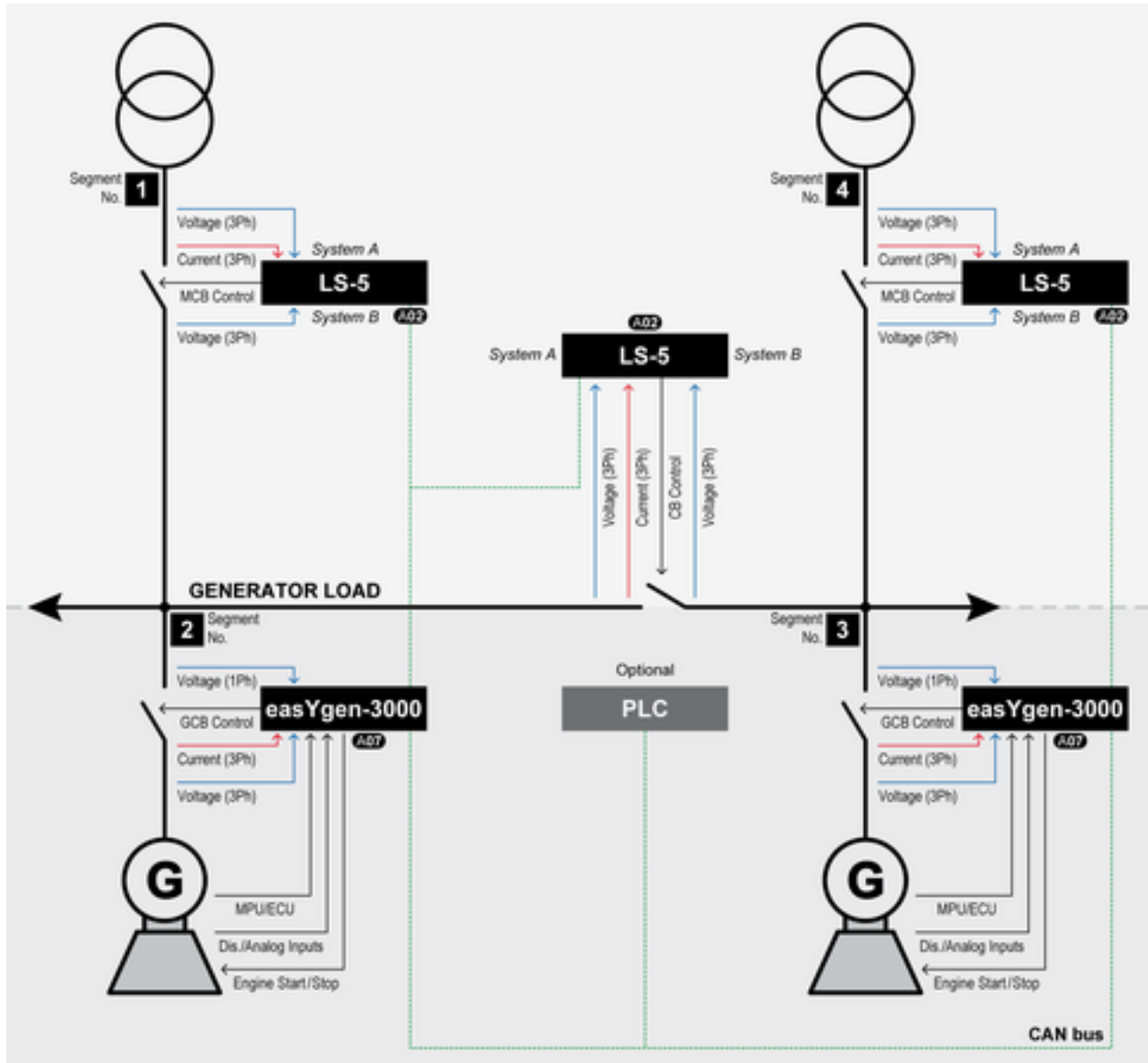

Fig. 133: H-Configuration with two easYgen and two incoming mains and tie-breaker

One or more genset(s) feed on a generator/load busbar (Fig. 133/ Segment No. 2). One or more genset(s) feed on a generator/load busbar (Fig. 133/Segment No. 3). A tie-breaker is located between the both generator/load busbars. Each generator/load busbar has its own incoming mains breaker (Fig. 133/ Segment No. 1/4).

The easYgen(s) are started by a remote start signal or by AMF mode and operating their GCBs. The other breakers, handled from the LS-5, receive their breaker open and close commands through orders coming from an external logic. The external logic could be a discrete input, a remote control bit, a monitor function, an easYgen command, etc..

In this example the decision when to close or open the breaker is managed by a PLC sending its orders over the CANopen protocol. Serial Modbus can also be used to send orders or read information from all members.



For additional information refer to [Chapter 7](#) "Interfaces And Protocols" on page 257.

Amongst others, the breaker feedbacks of the single LS-5 are sent via the CAN interface and inform all other connected devices in the system, whether they are interconnected or not. This determines the argument of the regulation for the easYgen (i.e. power control, frequency control, load sharing).

Required application modes:

- easYgen-3400/3500 or easYgen-3400XT/3500XT:
- LS-5:

General notes



Please note that the measured power of all LS-5s in the same segment are accumulated if there a several mains interchange points. The import/export control is based on this accumulated power. It is not possible to individually control the power at the single mains interchange points in the same segment.



All units must be configured according to the requirements listed in [Chapter 6.4.1](#) "Introduction" on page 215.

The following example does not contain any isolation switches, which could divide the segments.

Single line diagram

Prepare the easYgen – LS-5 system for configuration as follows:

- 1.** Draw a single line diagram that only contains essential equipment.

In this case the schematic should contain two incoming mains with MCBs, two or more generators per generator segment, and all breakers (tie-breaker, GCB, MCB).
- 2.** Number all easYgen control units from 1 to 32.
- 3.** Number all system LS-5s from 33 to 48.
- 4.** Number all CAN Node-IDs (usually the same as the device number).
- 5.** Number all segments according to the definitions in ["Segment number"](#) on page 216.



Unless special numbering conventions are required, count up continuously from left to right or right to left.

6. Draw the measurement system A and B of the single LS-5 into the single line diagram according to the definitions in [Chapter 6.4.1 "Introduction" on page 215](#).

Keep system A and B on the same side. This simplifies the configuration. The location of a CT may force you to ignore this rule but this can be compensated for in the configuration.

Prerequisites LS-5 (incoming mains)

Personnel: ■ Qualified electrician

Ensure the following prerequisites are met:

1. The system A voltage and current measurement is connected to the mains.
2. The system B voltage measurement is connected to the generator/load busbar.
3. The MCB breaker feedback is connected to the LS-5 only.
4. The MCB breaker commands are connected to the LS-5 only.
5. The LS-5 CAN bus is connected to the CAN bus #3 of the easYgen(s).

Prerequisites LS-5 (tie-breaker)

Personnel: ■ Qualified electrician

Ensure the following prerequisites are met:

1. The system A voltage and current measurement is connected to the generator/load busbar segment (Fig. 133/Segment No. 2).
2. The system B voltage measurement is connected to the generator/load busbar segment (Fig. 133/Segment No. 3).
3. The tie-breaker feedback is connected to the LS-5 only.
4. The tie-breaker commands are connected to the LS-5 only.
5. The LS-5 CAN bus is connected to the CAN bus #3 of the easYgen(s).

Prerequisites easYgen(s)

Personnel: ■ Qualified electrician

Ensure the following prerequisites are met:

1. The generator voltage and current measurement is connected to the generator.
2. The busbar voltage measurement is connected to the generator/load busbar.
3. The mains voltage measurement is not used.
4. The GCB breaker feedback is connected to the according easYgen.
5. The GCB breaker commands are connected to the according easYgen.
6. The easYgen CAN bus #3 is connected to the CAN bus of the LS-5.

Configure LS-5 (incoming mains)

Personnel: ■ User

Configure the following parameters:

1. ➤ Configure the application mode (parameter 8840 ↪ p. 120) of the LS-5 device to **400**.
2. ➤ Enter the device ID 33 for the LS-5, incoming mains on the left side and ID 35 for the LS-5, incoming mains on the right.
3. ➤ Enter the Node-IDs (usually the same like device ID).
4. ➤ For the following two steps navigate to *“Configuration ➔ Application config ➔ Segment config.”* on each respective LS-5.
5. ➤ Configure the following parameters for the LS-5 ID 33, incoming mains on the left side:

Parameter	ID	Value
Segment No. Sy.A	8810 ↪ p. 130	1
Segment No. Sy.B	8811 ↪ p. 130	2
Segment No. isol. Switch	8812 ↪ p. 130	N/A
Mains pow. Measurement	8813 ↪ p. 130	Valid
Mains connection	8814 ↪ p. 130	System A
Isol. Switch Para	8815 ↪ p. 131	None
Variable system	8816 ↪ p. 131	System B

6. ➤ Configure the following parameters for the LS-5 ID 35, incoming mains on the right side:

Parameter	ID	Value
Segment No. Sy.A	8810 ↪ p. 130	4
Segment No. Sy.B	8811 ↪ p. 130	3
Segment No. isol. Switch	8812 ↪ p. 130	N/A
Mains pow. Measurement	8813 ↪ p. 130	Valid
Mains connection	8814 ↪ p. 130	System A
Isol. Switch Para	8815 ↪ p. 131	None
Variable system	8816 ↪ p. 131	System B

7. ▶



When tapping voltages over power transformer, phase angle compensation may be required.

If a phase angle compensation over the MCB is required, navigate to “*Configuration → Application config → Breakers config. → Configure CBA → Synchronization CBA → Phase angle compensation*”



NOTICE!
Component damage

Incorrect settings may cause erratic system behavior and damage to the involved components .

- Set the values carefully and double check with a voltmeter at the according breaker.

8. ▶

Configure the breaker close and/or open relay(s) according to your MCB.

9. ▶

Check the synchronization settings, like phase angle, frequency window and voltage.

10. ▶

Navigate to “*Configuration → Application config → Breakers config. → Configure CBA → Dead bus closure CBA*” and set the following parameters:

Parameter	ID	Value
Dead bus closure CBA	8801 ↪ p. 120	On
Connect A dead to B dead	8802 ↪ p. 120	Off
Connect A dead to B alive	8803 ↪ p. 121	Off
Connect A alive to B dead	8804 ↪ p. 121	Off
Dead bus closure delay time	8805 ↪ p. 120	As required
Dead bus detection max. volt	5820 ↪ p. 120	As required

11. ▶

Navigate to “*Configuration → Application config → Breakers config. → Configure CBA → Connect synchronous mains*” and set the following parameters:

Parameter	ID	Value
Connect synchronous mains	8820 ↪ p. 126	Yes
Max. phase angle	8821 ↪ p. 127	20°
Delay time phi max.	8822 ↪ p. 127	1 s

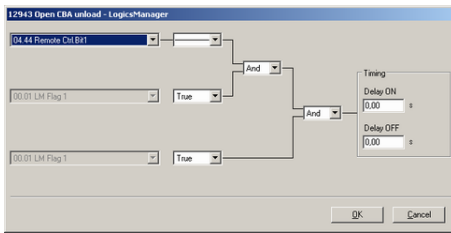

Fig. 134: LogicsManager configuration 'Open CBA unload'

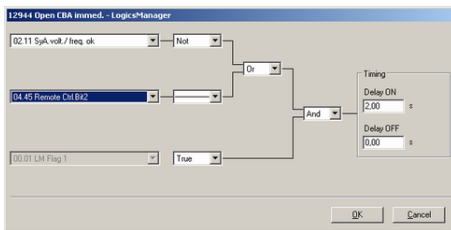

Fig. 135: LogicsManager configuration 'Open CBA immed.'

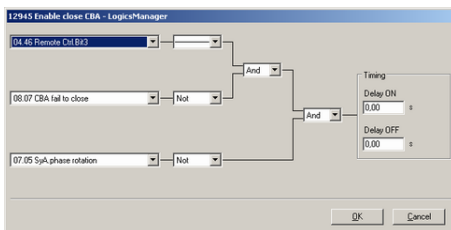

Fig. 136: LogicsManager configuration 'Enable close CBA.'

12. Select "Open CBA unload → LogicsManager" (parameter 12943 ↪ p. 122) and configure the equation as follows:

- The LM equation opens the MCB with unloading, if the remote control bit 1 is sent by the PLC.

13. Select "Open CBA immed. → LogicsManager" (parameter 12944 ↪ p. 122) and configure the equation as follows:

- The LM equation opens the MCB immediately, if the system A voltage / frequency is not within the configured operating ranges (refer to ↪ Chapter 4.3.1.1 "System A Operating Voltage / Frequency" on page 80) **OR** the remote control bit 2 sent by the PLC.

14. Select "Enable close CBA → LogicsManager" (parameter 12945 ↪ p. 122) and configure the equation as follows:

- The LM equation gives the release for close MCB, if the remote control bit 3 is sent by the PLC **AND** the CBA has no closure failure **AND** the system A measurement detects no phase rotation error.



The same remote control bits can be used in the upper example, because each LS-5 receives its own control bits. The different device and Node-ID separates the control bits from each other.

Configure LS-5 (tie-breaker)

Personnel: ■ User

Configure the following parameters:

1. Configure the application mode (parameter 8840 ↪ p. 120) of the LS-5 device to **4.02**.
2. Enter the device ID 34 for the LS-5.
3. Enter the Node-IDs (usually the same like device ID).

4. ➤ Navigate to “*Configuration ➔ Application config ➔ Segment config.*” and configure the following parameters:

Parameter	ID	Value
Segment No. Sy.A	8810 ↘ p. 130	2
Segment No. Sy.B	8811 ↘ p. 130	3
Segment No. isol. Switch	8812 ↘ p. 130	N/A
Mains pow. Measurement (Actually system A measurement)	8813 ↘ p. 130	Invalid
Mains connection	8814 ↘ p. 130	None
Isol. Switch Para	8815 ↘ p. 131	None
Variable system	8816 ↘ p. 131	System B

5. ➤ Configure the measurement system A and B.

6. ➤

 *When tapping voltages over power transformer, phase angle compensation may be required.*

If a phase angle compensation over the tie-breaker is required, navigate to “*Configuration ➔ Application config ➔ Breakers config. ➔ Configure CBA ➔ Synchronization CBA ➔ Phase angle compensation*”

 **NOTICE!**
Component damage
 Incorrect settings may cause erratic system behavior and damage to the involved components .

- Set the values carefully and double check with a voltmeter at the according breaker.

7. ➤ Configure the breaker close and/or open relay(s) according to your tie-breaker.

8. ➤ Check the synchronization settings, like phase angle, frequency window and voltage.

9. ➤ Navigate to “*Configuration ➔ Application config ➔ Breakers config. ➔ Configure CBA ➔ Dead bus closure CBA*” and set the following parameters:

Parameter	ID	Value
Dead bus closure CBA	8801 ↘ p. 120	On
Connect A dead to B dead	8802 ↘ p. 120	On
Connect A dead to B alive	8803 ↘ p. 121	On
Connect A alive to B dead	8804 ↘ p. 121	On
Dead bus closure delay time	8805 ↘ p. 120	As required
Dead bus detection max. volt	5820 ↘ p. 120	As required

10. Navigate to “*Configuration* → *Application config* → *Breakers config.* → *Configure CBA* → *Connect synchronous mains*” and set the following parameters:

Parameter	ID	Value
Connect synchronous mains	8820 ↵ p. 126	Yes
Max. phase angle	8821 ↵ p. 127	20°
Delay time phi max.	8822 ↵ p. 127	1 s

11. To configure the LogicsManager in regards to close and open commands for the tie-breaker navigate to “*Configuration* → *Application config* → *Breakers config.* → *Configure CBA*”.

12. Select “*Open CBA unload* → *LogicsManager*” (parameter 12943 ↵ p. 122) and configure the equation as follows:

- The LM equation opens the tie breaker with unloading, if the remote control bit 1 is sent by the PLC.



The unloading of the tie-breaker is only executed, if one side contains a variable system. Otherwise the open command is given without unloading.

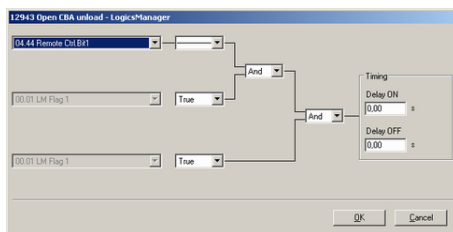

Fig. 137: LogicsManager configuration 'Open CBA unload'

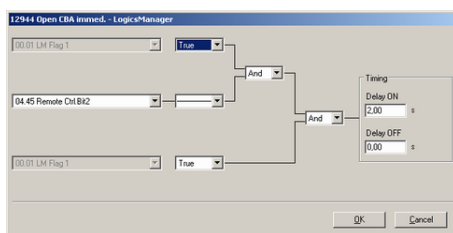

Fig. 138: LogicsManager configuration 'Open CBA immed.'

13. Select “*Open CBA immed.* → *LogicsManager*” (parameter 12944 ↵ p. 122) and configure the equation as follows:

- The LM equation opens the tie-breaker immediately, if the remote control bit 2 sent by the PLC.

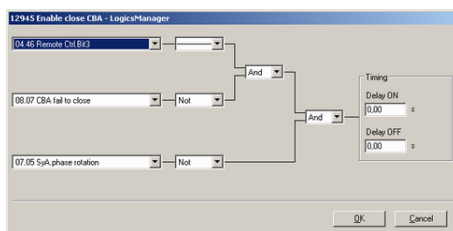

Fig. 139: LogicsManager configuration 'Enable close CBA.'

14. Select “*Enable close CBA* → *LogicsManager*” (parameter 12945 ↵ p. 122) and configure the equation as follows:

- The LM equation gives the release for close CBA, if the remote control bit 3 is sent by the PLC **AND** the CBA has no closure failure **AND** the system A measurement detects no phase rotation error.



The same remote control bits can be used in the upper example, because each LS-5 receives its own control bits. The different device and Node-ID separates the control bits from each other.

Configure easYgen(s)

Personnel: Admin User

Configure the following parameters:

1. Configure the application mode (parameter 3444) of each easYgen device to **007**.
2. Enter the device ID 1 for the easYgen (usually from left to right).
3. Enter the Node-IDs (usually the same like device ID).
4. Navigate to *“Parameter → Configuration → Configure Application → Configure Controller → Configure load share”* to enter the basic segment numbers at the easYgen(s).

Position	Parameter	ID	Value
easYgen ID 1 Left side	Segment number	1723	2
easYgen ID 2 Right side	Segment number	1723	3

5. Configure the measurement for generator and busbar according to the easYgen manual.
6. The mains measurement is not used in this application mode. A couple of settings should be configured as follows.

Switch off the following parameters:

Parameter	ID
Mains decoupling	3110
Change of frequency	3058
Overfrequency level 1	2850
Underfrequency level 1	2900
Overfrequency level 2	2856
Underfrequency level 2	2906
Overvoltage level 1	2950
Undervoltage level 1	3000
Overvoltage level 2	2956
Undervoltage level 2	3006
Mains voltage increase	8806

7. 

When tapping voltages over power transformer, phase angle compensation may be required.

If a phase angle compensation over the GCB is required, navigate to *"Configuration → Application config → Breakers config. → Configure GCB → Synchronization GCB → Phase angle compensation GCB"*

**NOTICE!****Component damage**

Incorrect settings may cause erratic system behavior and damage to the involved components .

- Set the values carefully and double check with a voltmeter at the according breaker.

8. 

To display the mains values coming from LS-5 on the main screen, navigate to *"Parameter → Configuration → Configure measurement"* and set *"Show mains data"* (parameter 4103) to "LS5".

9. 

For the AMF mode the emergency run segments have to be configured ( Chapter 6.4.2.6 "Setup AMF Start In LS-5 Mode" on page 221).

Navigate to *"Parameter → Configuration → Configure application → Configure emergency run"*.

In this application two setups are possible:

Example setup 1

Each generator group monitors its own generator/load busbar and mains income:

- The easYgens in the left group are configured to "segment 1" and "segment 2".
The easYgens on the left side start, if one of these 2 segments is running outside its operating ranges.
On the other side the AMF mode stops, if both segments are back in operating range and the incoming mains are closed.
- The easYgens in the right group are configured to "segment 3" and "segment 4".
The easYgens on the right side start, if one of these 2 segments is running outside its operating ranges.
On the other side the AMF mode stops, if both segments are back in operating range and the incoming mains are closed.

Example setup 2

All generators monitor both generator/load busbars and mains incomes.

- All easYgens are configured to "segment 1"; "segment 2"; "segment 3" and "segment 4".
All easYgen(s) start, if one of these 4 segments is running outside its operating ranges.
On the other side the AMF mode stops, if all segments are back in operating range and at least one incoming mains in the own segment is closed.

10.



In this setup each easYgen device provides six control bits for sending information to the LS-5.

These bits can be used as command variables in the LS-5 to initiate i.e. an alarm acknowledgement or to release the mains decoupling.

To configure these control bits navigate to "Parameter
 → Configuration → Configure LogicsManager
 → Configure LS5".

6.4.4 Multiple Mains/Generators With Four easYgen Units, Two Incoming Mains And Different Tie-breakers

Overview

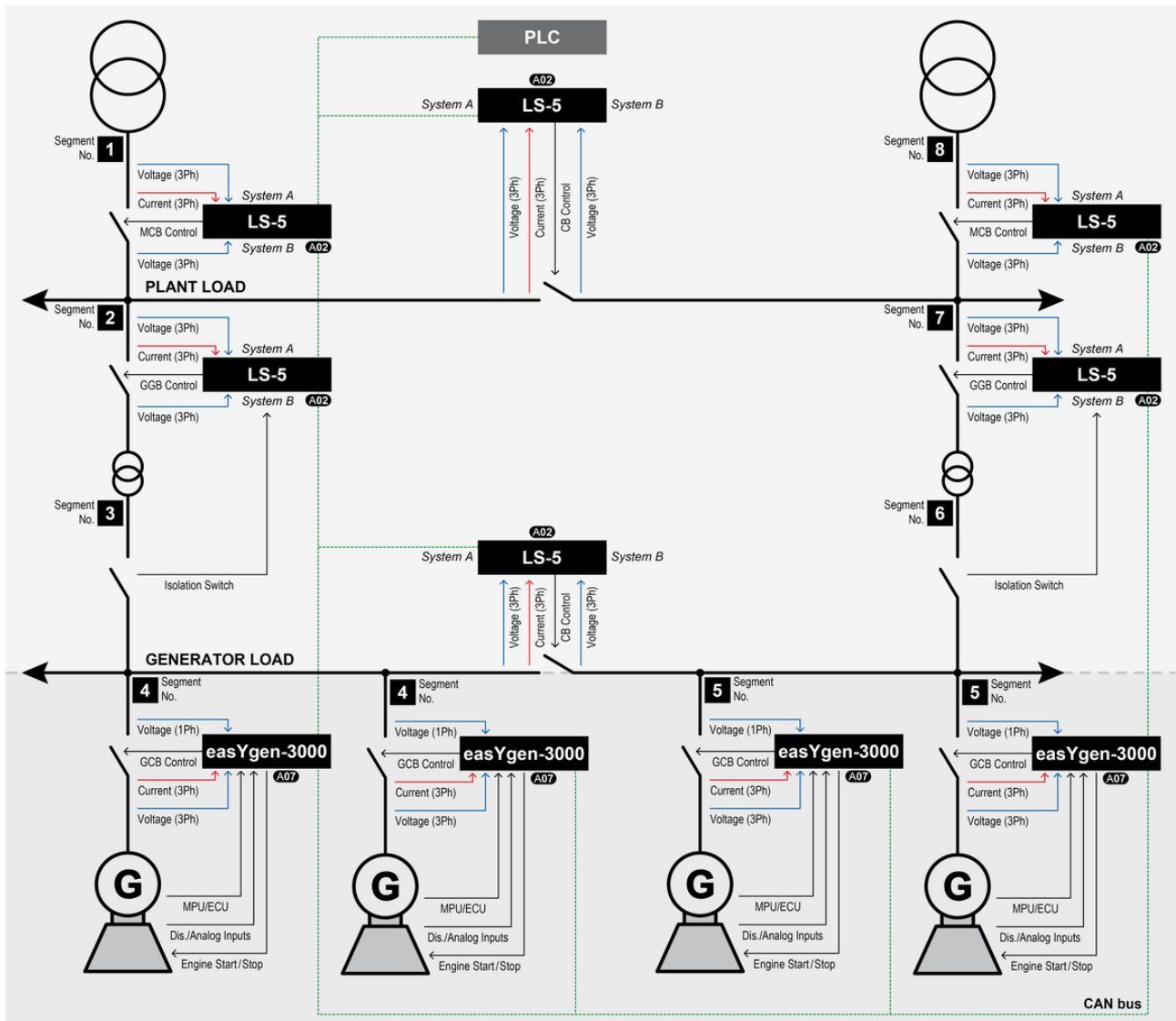

Fig. 140: Multiple Mains/Generators with four easYgen units, two incoming mains and different tie-breakers

One or more genset(s) feed on a generator/load busbar (Fig. 140/ Segment No. 4). One or more genset(s) feed on a generator/load busbar (Fig. 140/Segment No. 5).

A tie-breaker is located between the both generator/load busbars. Each generator/load busbar has its own generator group breaker (Fig. 140/Segment No. 2/3 respectively Segment No. 6/7). The application contains two mains interchange points with mains breakers (Fig. 140/Segment No. 1/2 respectively Segment No. 7/8).

Another tie-breaker can connect directly the both plant/load busbars (Fig. 140/Segment No. 2/7). The application example contains a middle voltage level for the plant/load busbar and a low voltage level for the generator/load busbar. Therefore step up transformers are installed. Each step up transformer provides a manually operated isolation switch.

Each LS-5 controls its own breaker. The LS-5s at the GGB are additionally informed about the condition of the close-by isolation switch.

The easYgen(s) are started by a remote start signal or by AMF mode and operating their GCBs. The other breakers, handled by LS-5, receive their breaker open and close commands through orders coming from an external logic. The external logic could be a discrete input, a remote control bit, a monitor function, etc..

In this example the decision when to close or open the breaker is managed by a PLC sending its orders over the CANopen protocol. Serial Modbus can also be used to send orders or read information from all members.



For additional information refer to [Chapter 7](#) "Interfaces And Protocols" on page 257.

Amongst others the breaker feedbacks of the single LS-5 are sent via CAN interface and inform all other connected devices in the system, whether they are interconnected or not. This determines the argument of the regulation for the easYgen (i.e. power control, frequency control, load sharing).

Required application modes:

- easYgen-3400/3500 or easYgen-3400XT/3500XT:
- LS-5:

General notes



All units must be configured according to the requirements listed in [Chapter 6.4.1](#) "Introduction" on page 215.

In the following example the isolation switch condition represents an important part of the segmenting.

Single line diagram

Prepare the easYgen – LS-5 system for configuration as follows:

1. Draw a single line diagram that only contains essential equipment.

In this case the schematic should contain two incoming mains with MCBs, two or more generators per generator/load busbar segment and all breakers (tie-breaker, GGB)

2. ➤ Number all easYgen control units from 1 to 32.
3. ➤ Number all system LS-5s from 33 to 48.
4. ➤ Number all CAN Node-IDs (usually the same as the device number).
5. ➤ Number all segments according to the definitions in ↗ “Segment number” on page 216.



Unless special numbering conventions are required, count up continuously from left to right or right to left.

6. ➤ Draw the measurement system A and B of the single LS-5 into the single line diagram according to the definitions in ↗ Chapter 6.4.1 “Introduction” on page 215.

Keep system A and B on the same side. This simplifies the configuration. The location of a CT may force you to ignore this rule but this can be compensated for in the configuration.

Prerequisites LS-5 (incoming mains)

Personnel: ■ Qualified electrician

Ensure the following prerequisites are met:

1. ➤ The system A voltage and current measurement is connected to the mains segment no. 1/8.
2. ➤ The system B voltage measurement is connected to the plant/load busbar segment no. 2/7.
3. ➤ The MCB breaker feedback is connected to the LS-5 only.
4. ➤ The MCB breaker commands are connected to the LS-5 only.
5. ➤ The LS-5 CAN bus is connected to the CAN bus #3 of the easYgen(s).

Prerequisites LS-5 (GGBs)

Personnel: ■ Qualified electrician

Ensure the following prerequisites are met:

1. ➤ The system A voltage and current measurement is connected to the plant/load busbar segment no. 2/7.
2. ➤ The system B voltage measurement is connected to the generator/load busbar segment no. 3/6.
3. ➤ The GGB feedback is connected to the LS-5 only.
4. ➤ The GGB command(s) are connected to the LS-5 only.
5. ➤ The isolation switch feedback, located between generator/load busbar and transformer(segment no.3/4 respectively segment no. 5/6), is connected to the LS-5 only.
6. ➤ The LS-5 CAN bus is connected to the CAN bus #3 of the easYgen(s).

Prerequisites LS-5 (tie-breaker generator/load busbar)

Personnel: ■ Qualified electrician

Ensure the following prerequisites are met:

1. ► The system A voltage and current measurement is connected to the segment no. 4.
2. ► The system B voltage measurement is connected to the segment no. 5.
3. ► The tie-breaker feedback is connected to the LS-5 only.
4. ► The tie-breaker command(s) are connected to the LS-5 only.
5. ► The LS-5 CAN bus is connected to the CAN bus #3 of the easYgen(s).

Prerequisites LS-5 (tie-breaker plant/load busbar)

Personnel: ■ Qualified electrician

Ensure the following prerequisites are met:

1. ► The system A voltage and current measurement is connected to the segment no. 2.
2. ► The system B voltage measurement is connected to the segment no. 7.
3. ► The tie-breaker feedback is connected to the LS-5 only.
4. ► The tie-breaker command(s) are connected to the LS-5 only.
5. ► The LS-5 CAN bus is connected to the CAN bus #3 of the easYgen(s).

Prerequisites easYgen(s)

Personnel: ■ Qualified electrician

Ensure the following prerequisites are met:

1. ► The generator voltage and current measurement is connected to the generator.
2. ► The busbar voltage measurement is connected to the generator/load busbar.
3. ► The mains voltage measurement is not used.
4. ► The GCB breaker feedback is connected to the according easYgen.
5. ► The GCB breaker command(s) are connected to the according easYgen.
6. ► The easYgen CAN bus #3 is connected to the CAN bus of the LS-5.

Configure LS-5 (incoming mains)

Personnel: User

Configure the following parameters:

1. ➤ Configure the application mode (parameter 8840 ↪ p. 120) of the LS-5 device to **402**.
2. ➤ Enter the device ID 33 for the LS-5, incoming mains on the left side and ID 37 for the LS-5, incoming mains on the right.
3. ➤ Enter the Node-IDs (usually the same like device ID).
4. ➤ For the following two steps navigate to *“Configuration ➔ Application config ➔ Segment config.”* on each respective LS-5.
5. ➤ Configure the following parameters for the LS-5 ID 33, incoming mains on the left side:

Parameter	ID	Value
Segment No. Sy.A	8810 ↪ p. 130	1
Segment No. Sy.B	8811 ↪ p. 130	2
Segment No. isol. Switch	8812 ↪ p. 130	N/A
Mains pow. Measurement	8813 ↪ p. 130	Valid
Mains connection	8814 ↪ p. 130	System A
Isol. Switch Para	8815 ↪ p. 131	None
Variable system	8816 ↪ p. 131	System B

6. ➤ Configure the following parameters for the LS-5 ID 37, incoming mains on the right side:

Parameter	ID	Value
Segment No. Sy.A	8810 ↪ p. 130	8
Segment No. Sy.B	8811 ↪ p. 130	7
Segment No. isol. Switch	8812 ↪ p. 130	N/A
Mains pow. Measurement	8813 ↪ p. 130	Valid
Mains connection	8814 ↪ p. 130	System A
Isol. Switch Para	8815 ↪ p. 131	None
Variable system	8816 ↪ p. 131	System B

7. ➤ Configure the measurement system A and B.
8. ➤ Configure the breaker close and/or open relay(s) according to your MCB.
9. ➤ Check the synchronization settings, like phase angle, frequency window and voltage.

10. Navigate to “*Configuration* → *Application config* → *Breakers config.* → *Configure CBA* → *Dead bus closure CBA*” and set the following parameters:

Parameter	ID	Value
Dead bus closure CBA	8801 ↵ p. 120	On
Connect A dead to B dead	8802 ↵ p. 120	Off
Connect A dead to B alive	8803 ↵ p. 121	Off
Connect A alive to B dead	8804 ↵ p. 121	On
Dead bus closure delay time	8805 ↵ p. 120	As required
Dead bus detection max. volt	5820 ↵ p. 120	As required

11. Navigate to “*Configuration* → *Application config* → *Breakers config.* → *Configure CBA* → *Connect synchronous mains*” and set the following parameters:

Parameter	ID	Value
Connect synchronous mains	8820 ↵ p. 126	Yes
Max. phase angle	8821 ↵ p. 127	20°
Delay time phi max.	8822 ↵ p. 127	1 s

12. To configure the LogicsManager in regards to close and open commands for the MCB navigate to “*Configuration* → *Application config* → *Breakers config.* → *Configure CBA*”.

13. Select “*Open CBA unload* → *LogicsManager*” (parameter 12943 ↵ p. 122) and configure the equation as follows:

- The LM equation opens the MCB with unloading, if the remote control bit 1 is sent by the PLC.

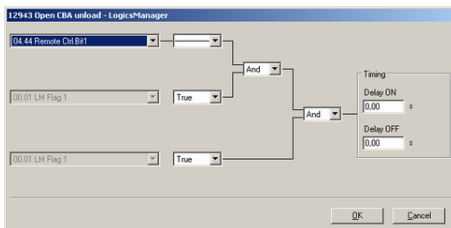

Fig. 141: LogicsManager configuration 'Open CBA unload'

14. Select “*Open CBA immed.* → *LogicsManager*” (parameter 12944 ↵ p. 122) and configure the equation as follows:

- The LM equation opens the MCB immediately, if the system A voltage / frequency is not within the configured operating ranges (refer to ↵ *Chapter 4.3.1.1 “System A Operating Voltage / Frequency” on page 80*) **OR** the remote control bit 2 sent by the PLC.

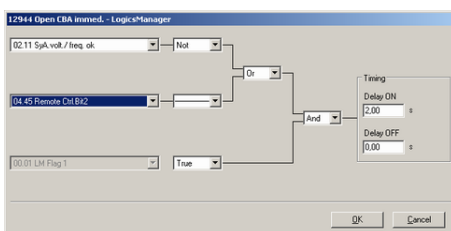

Fig. 142: LogicsManager configuration 'Open CBA immed.'

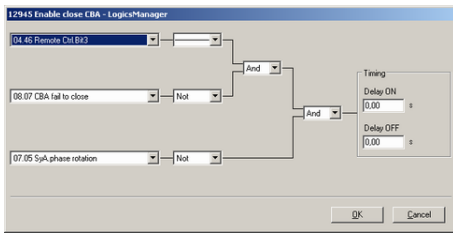

Fig. 143: LogicsManager configuration 'Enable close CBA.'

15. Select "Enable close CBA → LogicsManager" (parameter 12945 ↪ p. 122) and configure the equation as follows:

- The LM equation gives the release for close MCB, if the remote control bit 3 is sent by the PLC **AND** the CBA has no closure failure **AND** the system A measurement detects no phase rotation error.

i The same remote control bits can be used in the upper example, because each LS-5 receives its own control bits. The different device and Node-ID separates the control bits from each other.

Configure LS-5 (GGBs)

Personnel: User

Configure the following parameters:

1. Configure the application mode (parameter 8840 ↪ p. 120) of the LS-5 device to **402**.
2. Enter the device ID 34 for the LS-5, set up as GGB on the left and ID 36 for the LS-5, set up as GGB on the right.
3. Enter the Node-IDs (usually the same like device ID).
4. For the following two steps navigate to "Configuration → Application config → Segment config." on each respective LS-5.
5. Configure the following parameters for the LS-5 ID 34, set up as GGB on the left:

Parameter	ID	Value
Segment No. Sy.A	8810 ↪ p. 130	2
Segment No. Sy.B	8811 ↪ p. 130	3
Segment No. isol. Switch	8812 ↪ p. 130	4
Mains pow. Measurement (Actually system A measurement)	8813 ↪ p. 130	Invalid
Mains connection	8814 ↪ p. 130	None
Isol. Switch Para	8815 ↪ p. 131	System B
Variable system	8816 ↪ p. 131	System B

6. Configure the following parameters for the LS-5 ID 36, set up as GGB on the right:

Parameter	ID	Value
Segment No. Sy.A	8810 ↪ p. 130	7
Segment No. Sy.B	8811 ↪ p. 130	6
Segment No. isol. Switch	8812 ↪ p. 130	5
Mains pow. Measurement (Actually system A measurement)	8813 ↪ p. 130	Invalid
Mains connection	8814 ↪ p. 130	None
Isol. Switch Para	8815 ↪ p. 131	System B
Variable system	8816 ↪ p. 131	System B

7. ➤ Navigate to “*Configuration* ➔ *Application config* ➔ *Breakers config.*” and configure the isolation switch feedback “isol.sw open” for a discrete input (discrete input 5 is recommended).
8. ➤ Configure the measurement system A and B.
9. ➤ Configure the breaker close and/or open relay(s) according to your GGB.
10. ➤ Check the synchronization settings, like phase angle, frequency window and voltage.
11. ➤ Navigate to “*Configuration* ➔ *Application config* ➔ *Breakers config.* ➔ *Configure CBA* ➔ *Dead bus closure CBA*” and set the following parameters:

Parameter	ID	Value
Dead bus closure CBA	8801 ↪ p. 120	On
Connect A dead to B dead	8802 ↪ p. 120	On
Connect A dead to B alive	8803 ↪ p. 121	On
Connect A alive to B dead	8804 ↪ p. 121	On
Dead bus closure delay time	8805 ↪ p. 120	As required
Dead bus detection max. volt	5820 ↪ p. 120	As required

12. ➤ Navigate to “*Configuration* ➔ *Application config* ➔ *Breakers config.* ➔ *Configure CBA* ➔ *Connect synchronous mains*” and set the following parameters:

Parameter	ID	Value
Connect synchronous mains	8820 ↪ p. 126	Yes
Max. phase angle	8821 ↪ p. 127	20°
Delay time phi max.	8822 ↪ p. 127	1 s

13. ➤ To configure the LogicsManager in regards to close and open commands for the GGB navigate to “*Configuration* ➔ *Application config* ➔ *Breakers config.* ➔ *Configure CBA*”.

14. ➤ Select “*Open CBA unload* ➔ *LogicsManager*” (parameter 12943 ↪ p. 122) and configure the equation as follows:

- The LM equation opens the GGB with unloading, if the remote control bit 1 is sent by the PLC.

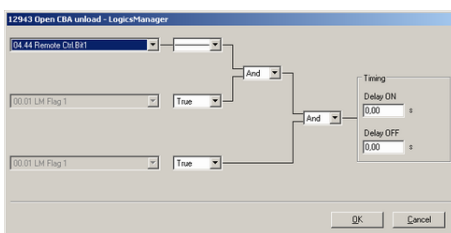

Fig. 144: LogicsManager configuration 'Open CBA unload'

15. ➤ Select “*Open CBA immed.* ➔ *LogicsManager*” (parameter 12944 ↪ p. 122) and configure the equation as follows:

- The LM equation opens the GGB immediately, if the remote control bit 2 sent by the PLC.

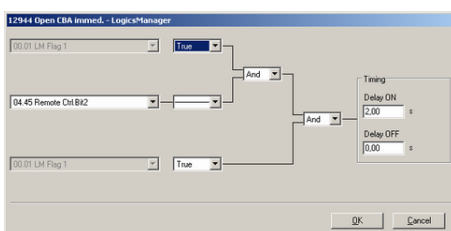

Fig. 145: LogicsManager configuration 'Open CBA immed.'

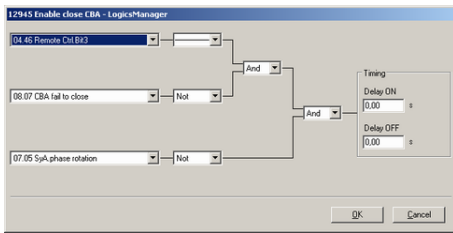

Fig. 146: LogicsManager configuration 'Enable close CBA.'

16. Select “Enable close CBA → LogicsManager” (parameter 12945 ↪ p. 122) and configure the equation as follows:

- The LM equation gives the release for close GGB, if the remote control bit 3 is sent by the PLC **AND** the CBA has no closure failure **AND** the system A measurement detects no phase rotation error.



The same remote control bits can be used in the upper example, because each LS-5 receives its own control bits. The different device and Node-ID separates the control bits from each other.

Configure LS-5 (tie-breaker generator/load busbar)

Personnel: User

Configure the following parameters:

1. Configure the application mode (parameter 8840 ↪ p. 120) of the LS-5 device to **400**.
2. Enter the device ID 35 for the LS-5.
3. Enter the Node-ID (usually the same like device ID).
4. Navigate to “Configuration → Application config → Segment config.” and configure the following parameters:

Parameter	ID	Value
Segment No. Sy.A	8810 ↪ p. 130	4
Segment No. Sy.B	8811 ↪ p. 130	5
Segment No. isol. Switch	8812 ↪ p. 130	N/A
Mains pow. Measurement (Actually system A measurement)	8813 ↪ p. 130	Invalid
Mains connection	8814 ↪ p. 130	None
Isol. Switch Para	8815 ↪ p. 131	None
Variable system	8816 ↪ p. 131	System A

5. Configure the measurement system A and B.
6. Configure the breaker close and/or open relay(s) according to your tie-breaker.
7. Check the synchronization settings, like phase angle, frequency window and voltage.

8. Navigate to “*Configuration* → *Application config* → *Breakers config.* → *Configure CBA* → *Dead bus closure CBA*” and set the following parameters:

Parameter	ID	Value
Dead bus closure CBA	8801 ↵ p. 120	On
Connect A dead to B dead	8802 ↵ p. 120	On
Connect A dead to B alive	8803 ↵ p. 121	On
Connect A alive to B dead	8804 ↵ p. 121	On
Dead bus closure delay time	8805 ↵ p. 120	As required
Dead bus detection max. volt	5820 ↵ p. 120	As required

9. Navigate to “*Configuration* → *Application config* → *Breakers config.* → *Configure CBA* → *Connect synchronous mains*” and set the following parameters:

Parameter	ID	Value
Connect synchronous mains	8820 ↵ p. 126	Yes
Max. phase angle	8821 ↵ p. 127	20°
Delay time phi max.	8822 ↵ p. 127	1 s

10. To configure the LogicsManager in regards to close and open commands for the tie-breaker navigate to “*Configuration* → *Application config* → *Breakers config.* → *Configure CBA*”.

11. Select “*Open CBA unload* → *LogicsManager*” (parameter 12943 ↵ p. 122) and configure the equation as follows:

- The LM equation opens the tie-breaker with unloading, if the remote control bit 1 is sent by the PLC.



The unloading of the tie-breaker is only executed, if one side contains a variable system. Otherwise the open command is given without unloading.

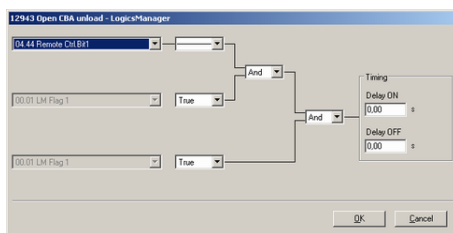

Fig. 147: LogicsManager configuration 'Open CBA unload'

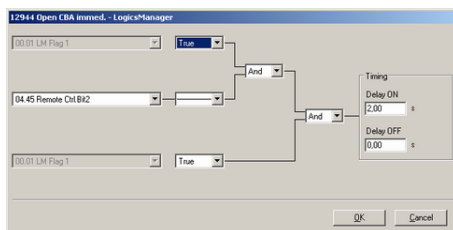

Fig. 148: LogicsManager configuration 'Open CBA immed.'

12. Select “*Open CBA immed.* → *LogicsManager*” (parameter 12944 ↵ p. 122) and configure the equation as follows:

- The LM equation opens the tie-breaker immediately, if the remote control bit 2 sent by the PLC.

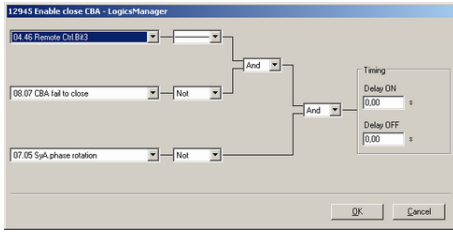

Fig. 149: LogicsManager configuration 'Enable close CBA.'

13. Select "Enable close CBA → LogicsManager" (parameter 12945 ↪ p. 122) and configure the equation as follows:

- The LM equation gives the release for close CBA, if the remote control bit 3 is sent by the PLC **AND** the CBA has no closure failure **AND** the system A measurement detects no phase rotation error.



The same remote control bits can be used in the upper example, because each LS-5 receives its own control bits. The different device and node-ID separates the control bits from each other.

Configure LS-5 (tie-breaker plant/load busbar)

Personnel: User

Configure the following parameters:

1. Configure the application mode (parameter 8840 ↪ p. 120) of the LS-5 device to **400**.
2. Enter the device ID 38 for the LS-5.
3. Enter the Node-ID (usually the same like device ID).
4. Navigate to "Configuration → Application config → Segment config." and configure the following parameters:

Parameter	ID	Value
Segment No. Sy.A	8810 ↪ p. 130	2
Segment No. Sy.B	8811 ↪ p. 130	7
Segment No. isol. Switch	8812 ↪ p. 130	N/A
Mains pow. Measurement (Actually system A measurement)	8813 ↪ p. 130	Invalid
Mains connection	8814 ↪ p. 130	None
Isol. Switch Para	8815 ↪ p. 131	None
Variable system	8816 ↪ p. 131	System A

5. Configure the measurement system A and B.
6. Configure the breaker close and/or open relay(s) according to your tie-breaker.
7. Check the synchronization settings, like phase angle, frequency window and voltage.

8. Navigate to “*Configuration* → *Application config* → *Breakers config.* → *Configure CBA* → *Dead bus closure CBA*” and set the following parameters:

Parameter	ID	Value
Dead bus closure CBA	8801 ↵ p. 120	On
Connect A dead to B dead	8802 ↵ p. 120	On
Connect A dead to B alive	8803 ↵ p. 121	On
Connect A alive to B dead	8804 ↵ p. 121	On
Dead bus closure delay time	8805 ↵ p. 120	As required
Dead bus detection max. volt	5820 ↵ p. 120	As required

9. Navigate to “*Configuration* → *Application config* → *Breakers config.* → *Configure CBA* → *Connect synchronous mains*” and set the following parameters:

Parameter	ID	Value
Connect synchronous mains	8820 ↵ p. 126	Yes
Max. phase angle	8821 ↵ p. 127	20°
Delay time phi max.	8822 ↵ p. 127	1 s

10. To configure the LogicsManager in regards to close and open commands for the tie-breaker navigate to “*Configuration* → *Application config* → *Breakers config.* → *Configure CBA*”.

11. Select “*Open CBA unload* → *LogicsManager*” (parameter 12943 ↵ p. 122) and configure the equation as follows:

- The LM equation opens the tie-breaker with unloading, if the remote control bit 1 is sent by the PLC.



The unloading of the tie-breaker is only executed, if one side contains a variable system. Otherwise the open command is given without unloading.

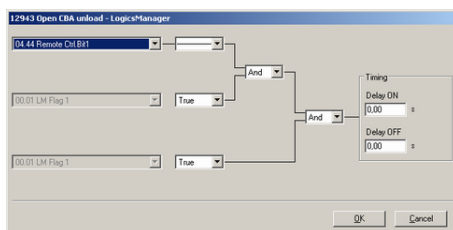

Fig. 150: LogicsManager configuration 'Open CBA unload'

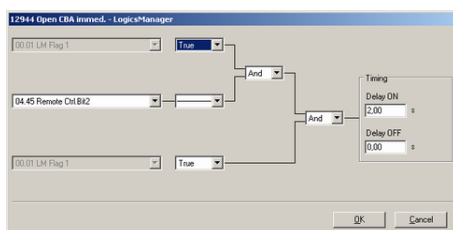

Fig. 151: LogicsManager configuration 'Open CBA immed.'

12. Select “*Open CBA immed.* → *LogicsManager*” (parameter 12944 ↵ p. 122) and configure the equation as follows:

- The LM equation opens the tie-breaker immediately, if the remote control bit 2 sent by the PLC.

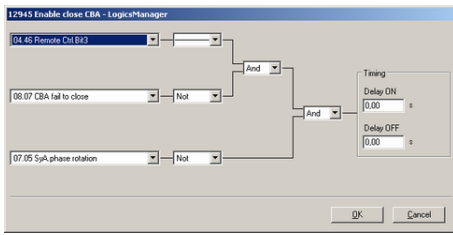

Fig. 152: LogicsManager configuration 'Enable close CBA.'

13. Select "Enable close CBA → LogicsManager" (parameter 12945 p. 122) and configure the equation as follows:

- The LM equation gives the release for close CBA, if the remote control bit 3 is sent by the PLC **AND** the CBA has no closure failure **AND** the system A measurement detects no phase rotation error.



The same remote control bits can be used in the upper example, because each LS-5 receives its own control bits. The different device and Node-ID separates the control bits from each other.

Configure easYgen(s)

Personnel: User

Configure the following parameters:

1. Configure the application mode (parameter 3444) of each easYgen device to **400**.
2. Enter the device ID 1 for the easYgen (usually from left to right).
3. Enter the Node-IDs (usually the same like device ID).
4. Navigate to "Parameter → Configuration → Configure Application → Configure Controller → Configure load share" to enter the basic segment numbers at the easYgen(s).

Position	Parameter	ID	Value
easYgen ID 1 Left side	Segment number	1723	4
easYgen ID 2 Right side	Segment number	1723	5

5. Configure the measurement for generator and busbar according to the easYgen manual.

6. ➤ The mains measurement is not used in this application mode. A couple of settings should be configured as follows.

- Switch off the following parameters:

Parameter	ID
Mains decoupling	3110
Change of frequency	3058
Overfrequency level 1	2850
Underfrequency level 1	2900
Overfrequency level 2	2856
Underfrequency level 2	2906
Overvoltage level 1	2950
Undervoltage level 1	3000
Overvoltage level 2	2956
Undervoltage level 2	3006
Mains voltage increase	8806

7. ➤



When tapping voltages over power transformer, phase angle compensation may be required.

If a phase angle compensation over the GCB is required, navigate to *“Configuration → Application config → Breakers config. → Configure GCB → Synchronization GCB → Phase angle compensation GCB”*



NOTICE!
Component damage

Incorrect settings may cause erratic system behavior and damage to the involved components .

- Set the values carefully and double check with a voltmeter at the according breaker.

8. ➤ To display the mains values coming from LS-5 on the main screen, navigate to *“Parameter → Configuration → Configure measurement”* and set *“Show mains data”* (parameter 4103) to *“LS5”*.

9. 

For the AMF mode the emergency run segments have to be configured (↗ Chapter 6.4.2.6 "Setup AMF Start In LS-5 Mode" on page 221).

Navigate to "Parameter → Configuration
→ Configure application → Configure emergency run".

In this application two setups are possible:

Example setup 1

Each generator group monitors its own generator/load busbar and mains income:

- The easYgens in the left group are configured to "segment 1"; "segment 2" and "segment 4".
The easYgens on the left side start, if at least one of these 3 segments is running outside its operating ranges.
On the other side the AMF mode stops, if all segments are back in operating range and the incoming mains are closed.
- The easYgens in the right group are configured to "segment 8"; "segment 7" and "segment 5".
The easYgens on the right side start, if at least one of these 3 segments is running outside its operating ranges.
On the other side the AMF mode stops, if all segments are back in operating range and the incoming mains are closed.

Example setup 2

All generators monitor both generator/load busbars and mains incomes.

- All easYgens are configured to "segment 1"; "segment 2"; "segment 4"; "segment 8"; "segment 7" and "segment 5".
All easYgen(s) start, if at least one of these 6 segments is running outside its operating ranges.
On the other side the AMF mode stops, if all segments are back in operating range and at least one incoming mains in the own segment is closed.

10. 

In this setup each easYgen device provides six control bits for sending information to the LS-5.

These bits can be used as command variables in the LS-5 to initiate i.e. an alarm acknowledgement or to release the mains decoupling.

To configure these control bits navigate to "Parameter
→ Configuration → Configure LogicsManager
→ Configure LS5".

6.5 Setup VDE-AR-N 4105 Applications

6.5.1 Introduction

This chapter shall inform about the possibilities how the LS-521 can be used in cooperation with the easYgen-3000(XT) to match the VDE-AR-N 4105 mains directive requirement. The easYgen-3000(XT) and the LS-521 are products which contain the mains decoupling. Through the demanded one failure security in the system both devices must be involved. In most cases the LS-521 acts together with an easYgen-3500(XT), in few cases with

an easYgen-3200(XT). Some typical applications are shown below. For more information please refer to the according FNN VDE-AR-N 4105 document. To help in these specific applications Woodward provides also an application note with more details and how to configure the devices.

6.5.2 easYgen-3200XT (Mode GCB/MCB) with LS-521 as separate mains decoupling device

The easYgen-3200(XT) performs an island and mains parallel operation. The easYgen and the LS-521 act simultaneously as protection devices for mains decoupling. The easYgen-3200(XT) operates the GCB and the MCB according to the application mode GCB/MCB. The LS-521 is additionally equipped to fulfill the VDE-AR-N 4105 requirement. It only causes the opening of the MCB. The LS-521 is configured on the application mode 'Single LS5'.



In this mode the LS-521 is only used like a protective device and fulfills nothing besides the mains decoupling.

The mains decoupling is enabled, if GCB and MCB are closed. So the breaker feedback signals must be provided to both devices.

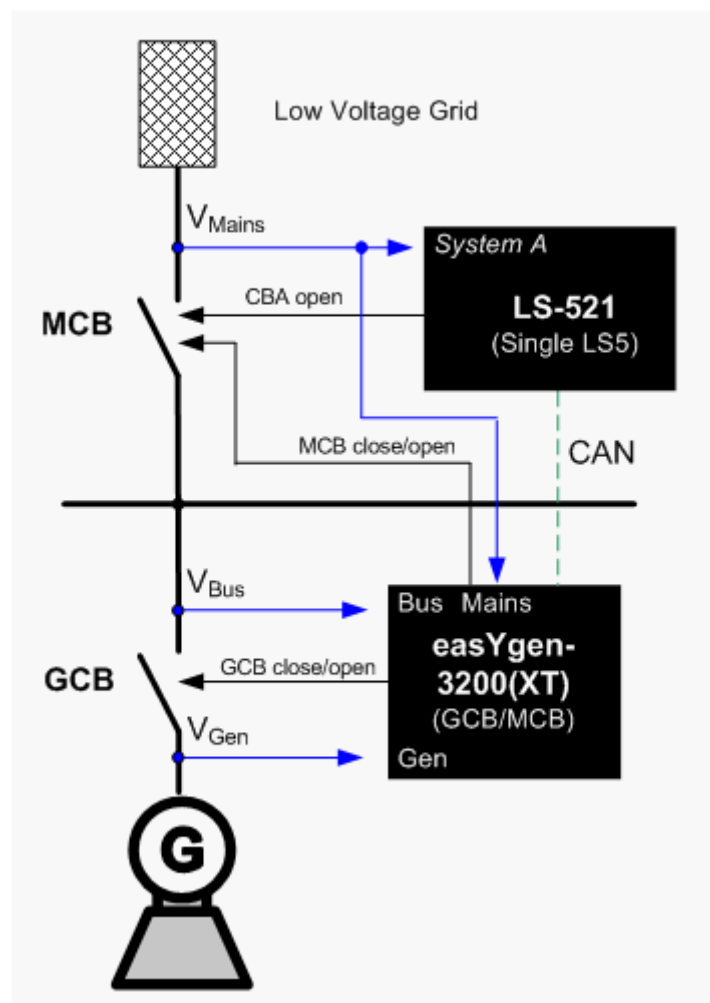

Fig. 153: Example: easYgen-3200(XT) (GCB/MCB mode) and LS-521 (Single LS5 mode)

6.5.3 One easYgen-3500(XT) (Mode GCB/L-MCB or GCB/GGB/L-MCB) with LS-521

The easYgen-3500(XT) performs an island and mains parallel operation. In this application the LS-521 serves the MCB. The MCB will be opened and closed by the LS-521. The LS-521 is configured to the application mode L-MCB. The application mode of the easYgen-3500(XT) can be configured as GCB/L-MCB or GCB/GGB/L-MCB. The easYgen does not have direct access on the MCB here.

The mains voltage measurement of the easYgen must be connected in such a way that the easYgen can take part of the mains decoupling function, too.

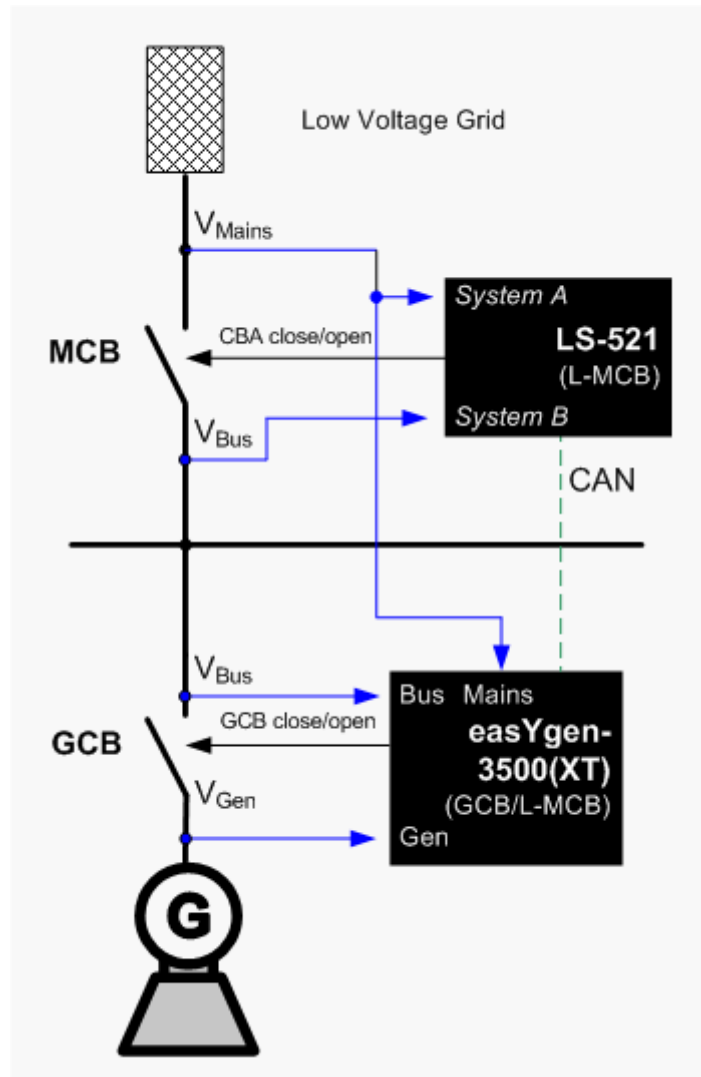

Fig. 154: Example: easYgen-3500(XT) (GCB/L-MCB mode) and LS-521 (L-MCB mode)

6.5.4 Multiple easYgen-3500(XT) (Mode GCB/L-MCB or GCB/GGB/L-MCB) with LS-521

This application multiple easYgen-3500(XT) serve the mains breaker via one LS-521. The principle is the same like in the chapter before. The difference is that multiple easYgens (gensets) act on one mains interchange point. So it is important to consider that the mains measurement must be connected with each easYgen-3500(XT).

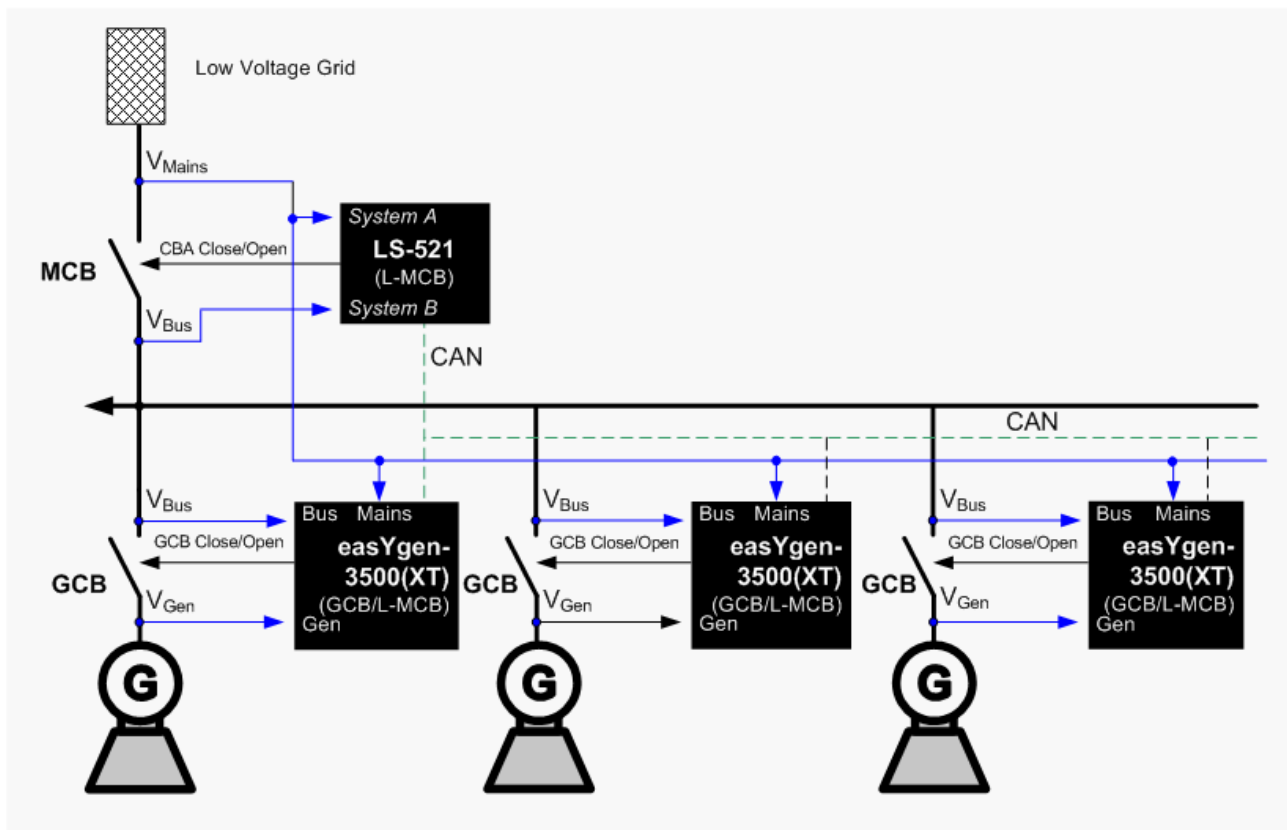

Fig. 155: Example: Multiple easYgen-3500(XT) (GCB/L-MCB mode) and an LS-521 (L-MCB mode)

6.5.5 System easYgen-3500(XT) (Mode GCB/LS5) with LS-521

The easYgen-3500(XT) and the LS-521 run in the 'LS5' mode. So the mains decoupling must be maintained with two breakers in series to fulfill the VDE-AR-N 4105 rule. There must not be any branch between both breakers. The two breakers are usually either installed as MCBs at the interchange point to the grid or as GCBs at the generator side.

The first breaker is the general breaker which is needed for the general functionality. The second breaker is only installed to fulfill the VDE-AR-N 4105 requirement. The second breaker is served by an LS-521, which has the task to do the redundant mains decoupling only. Both units are a pair and monitor each other.

Two applications within the mentioned application mode are introduced:

- Mains decoupling monitoring at the interchange point: realized by two LS-521
- Mains decoupling monitoring at the generator feed-in: realized by an easYgen-3500(XT) and an LS-521

6.5.5.1 Mains Decoupling Monitoring at the Interchange Point

Overview

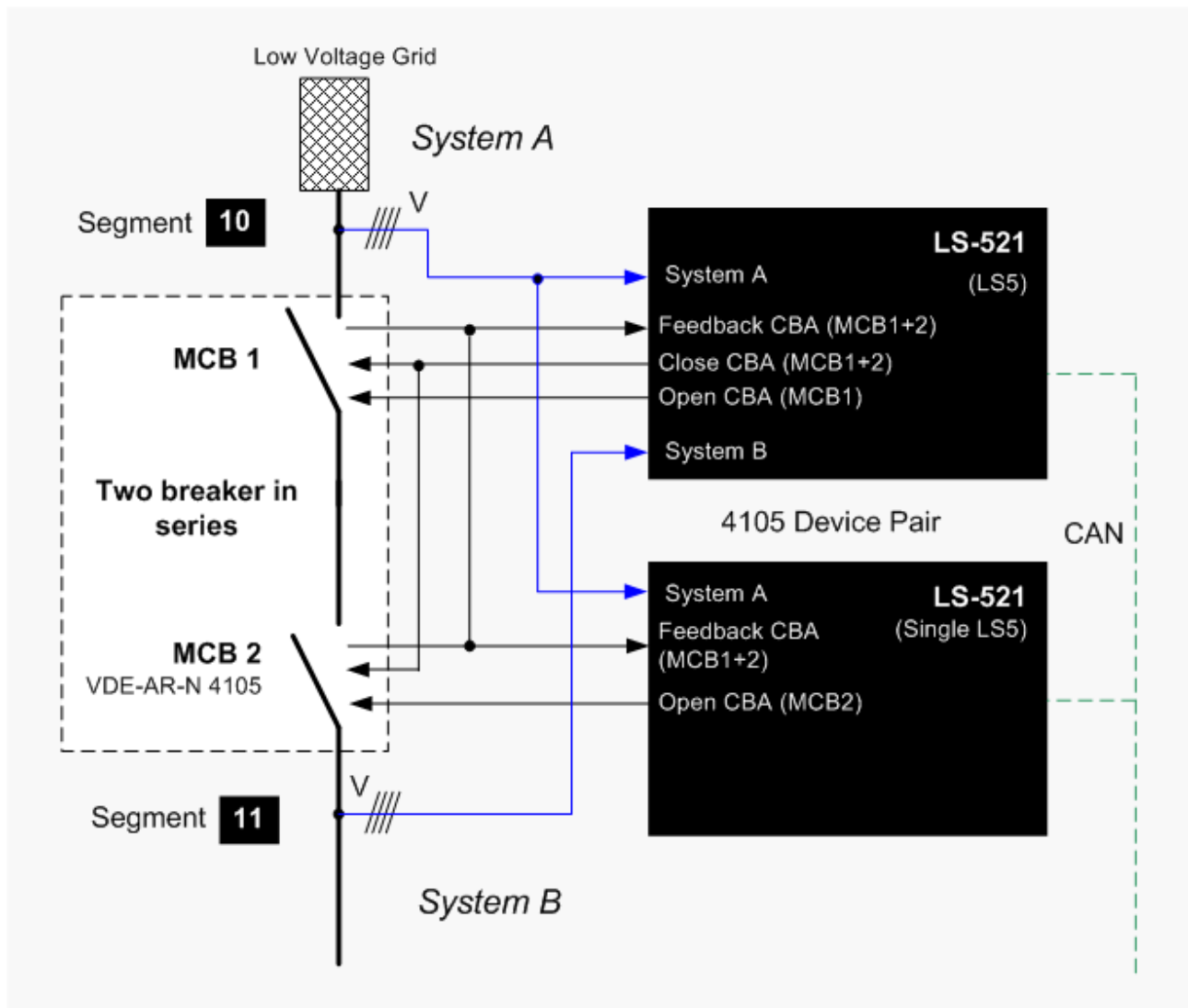

Fig. 156: Example: Mains decoupling monitoring at the interchange point in with two LS-521 (one device in LS5 mode and one in Single LS5 mode)

Both LS-521 measure the mains voltage as system A voltages. Both devices execute the mains decoupling, whereby the main device opens the MCB1 and the additional device opens the MCB2. The closure or the synchronization of both breakers are maintained by the main device. The feedback signal of both breakers are considered and connected to both devices.

6.5.5.2 Mains Decoupling Monitoring at the Generator Feed-in

Overview

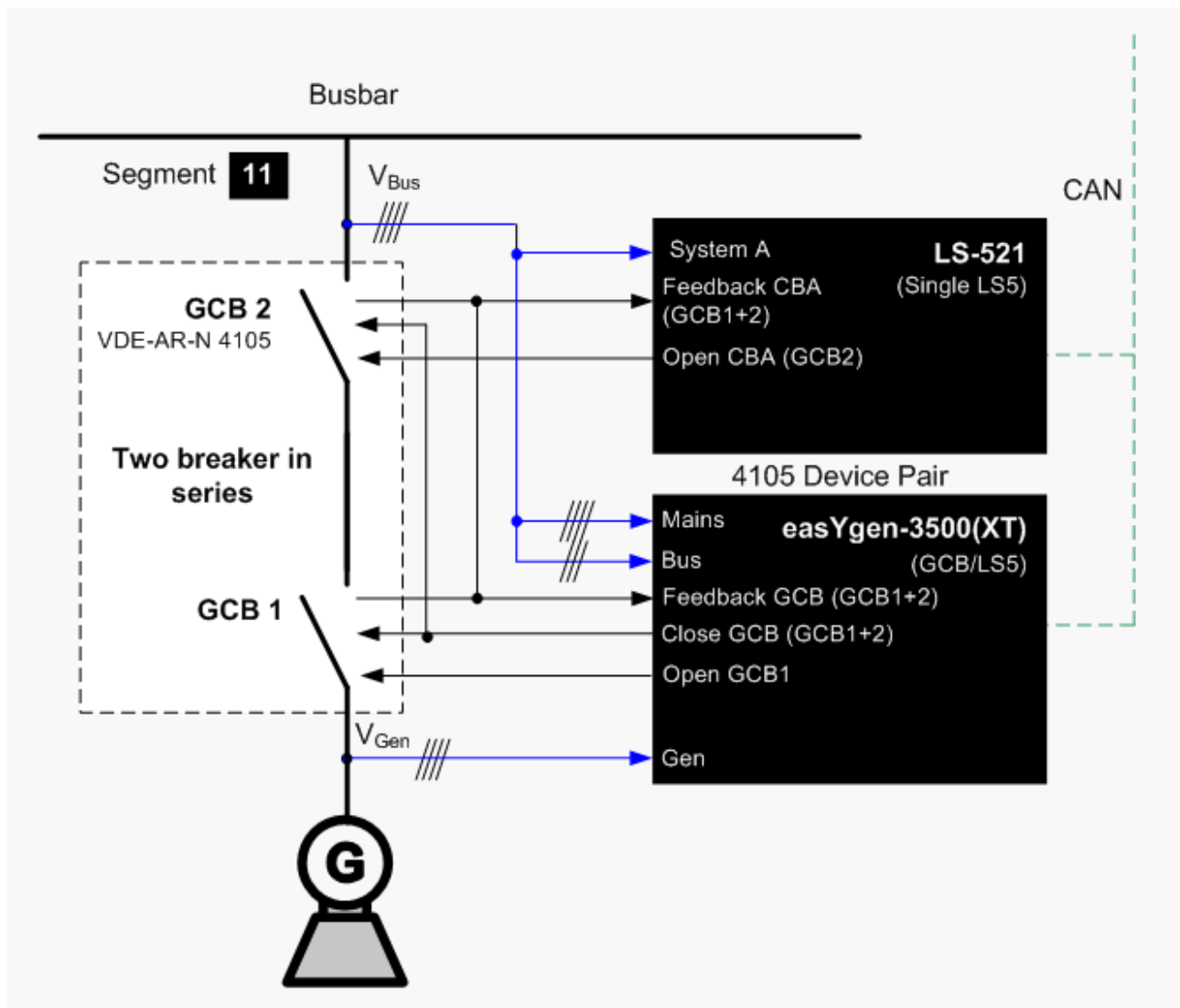

Fig. 157: Example: Mains decoupling monitoring at the generator feed-in point with LS-521 (Single LS5 mode) and easYgen-3500(XT) (GCB/LS5 mode)

The easYgen-3500(XT) mains measurement and the LS-521 system A measurement are connected with the busbar. The busbar voltage is considered for the mains decoupling monitoring. So the mains decoupling monitoring acts only on the generator feed-in. The easYgen-3500(XT) opens the GCB1 and the LS-521 opens the GCB2. The feedback of both breakers is connected to both devices. The easYgen does the closure respectively synchronization of both breakers.

Application

Setup VDE-AR-N 4105 Applicat... > System easYgen-3500(XT) (M... > Mains Decoupling Monitorin...

7 Interfaces And Protocols

7.1 Interfaces

7.1.1 Interfaces Overview

LS-51x

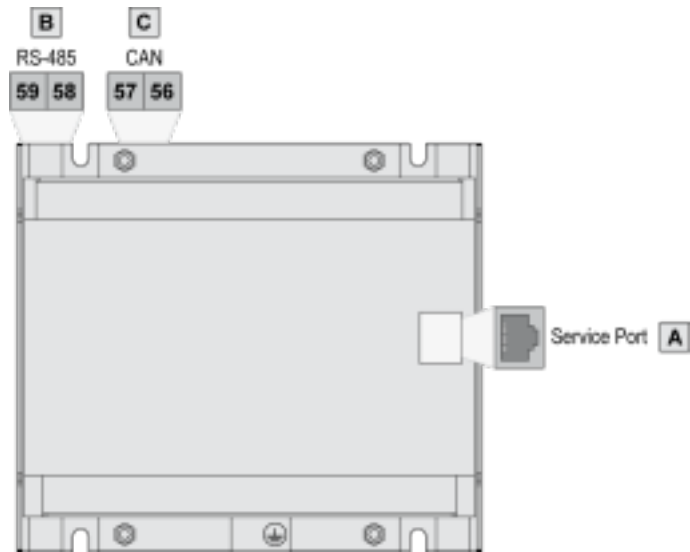

Fig. 158: LS-51x interfaces

LS-52x

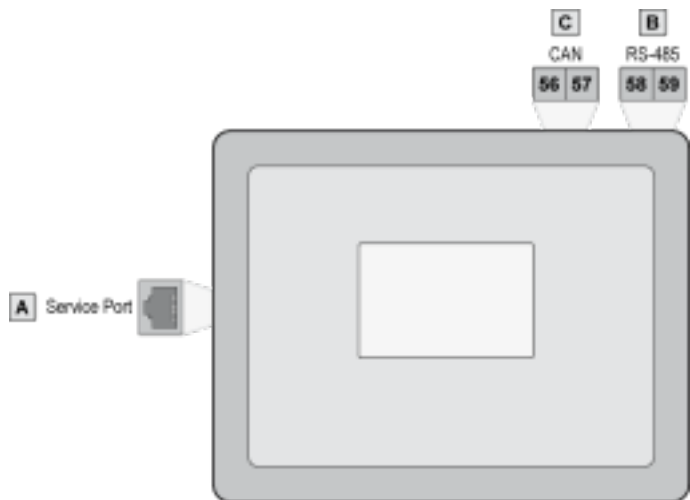

Fig. 159: LS-52x interfaces

The LS-5 (Fig. 158/Fig. 159) provides the following interfaces, which are supporting different protocols.

Figure	Interface	Protocol
A	Service Port (USB/RS-232) ¹	Modbus, ToolKit
B	RS-485	Modbus
C	CAN bus	CANopen



¹ Please refer to [Chapter 3.3.11 "Service Port"](#) on page 62.

7.1.2 CAN Interfaces

7.1.2.1 CAN Interface 1 (Guidance level)

CAN interface 1 is a freely configurable CANopen interface with 2 RPDOs (receive boxes), 3 TPDOs (send boxes), and 4 additional Server SDOs.

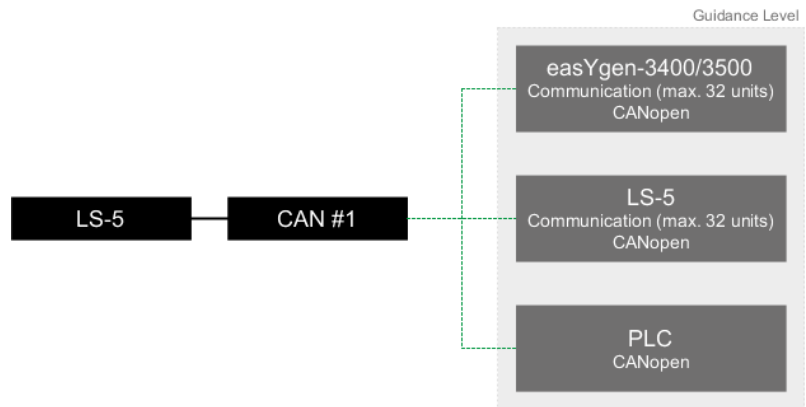

Fig. 160: CAN interface 1



The band width of the CAN bus allows to connect up to 32 easYgens in conjunction with up to 16 LS-5 devices. This is always guaranteed. In particular cases it could be desired to run more than 16 LS-5 devices. Theoretically up to 32 LS-5 are possible, but it requires in return a reduced number of easYgen devices. A rule of thumb is that the total amount of easYgens and LS-5s shall never expire 48 devices. To be on the safe side please discuss the possible risks with the Woodward Sales Support.

7.1.3 Serial Interfaces

7.1.3.1 Service Port (RS-232/USB)

The Woodward specific service port can be used to extend the interfaces of the controller.

In conjunction with the direct configuration cable the service port allows service access for configuring the unit and visualize measured data. It is possible to connect a modem for remote control and alarm signaling.

The extended serial interface provides a Modbus as well as the Woodward ToolKit protocol.

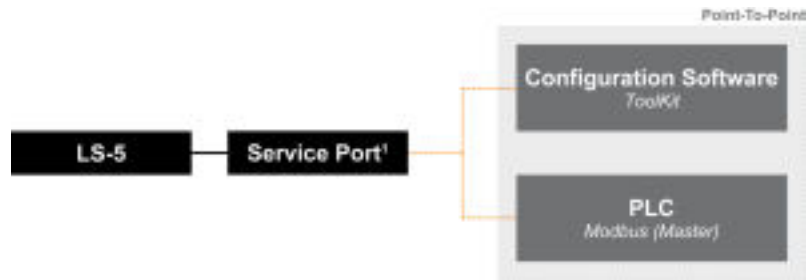

Fig. 161: Service Port



¹ The service port can be **only** used in combination with an optional Woodward direct configuration cable (DPC), which includes a converter box to provide either an USB or a RS-232 interface.

- For additional information refer to [Chapter 3.3.11 "Service Port"](#) on page 62.

7.1.3.2 RS-485 Interface

A freely configurable RS-485 Modbus RTU Slave interface is provided to add PLC connectivity. It is also possible to configure the unit, visualize measured data and alarm messages, and control the unit remotely.



Fig. 162: RS-485 interface

7.2 Protocols

7.2.1 Protocols Overview

The following data protocols are implemented to be used via the appropriate interfaces

Modbus via RS-232/-485

- 5300: Basic Visualization

CANopen via CAN interface

- 5301: Basic Visualization
- 5302: Basic Visualization
- 6003: LS-5 Communication

7.2.2 CANopen Protocol

CANopen is a communication protocol and device profile specification for embedded systems used in automation. The CANopen standard consists of an addressing scheme, several small communication protocols and an application layer defined by a device profile. The communication protocols have support for network management, device monitoring and communication between nodes, including a simple transport layer for message segmentation/desegmentation.

Protocol description

If a data protocol is used, a CAN message looks like this:

Byte 1	Byte 2	Byte 3	Byte 4	Byte 5	Byte 6	Byte 7	Byte 8
MUX	Data byte	Data byte	Data byte	Data byte	Data byte	Data byte	Internal

The MUX byte is counted up, the meaning of the data byte changes according to the value of the MUX byte.

In the protocol tables is listed which parameter at which MUX on which position is transmitted. The meaning of the parameter can be taken by means of the number of the parameter description ("CANopen Mapping parameter").

Example

MUX	Byte 2	Byte 3	Byte 4	Byte 5	Byte 6	Byte 7	Byte 8
1	118				147		Internal

In MUX 1 (byte 1 has got value 1) the value of parameter 118 is included in the byte 2 up to byte 5 (mains voltage 1-2). In byte 6 up to byte 7 the value of parameter 147 is included (mains frequency). Byte 8 includes internal definitions and shall be ignored.

Data format

The data format of "Signed integer" and "Unsigned integer" is "Little Endian".

UNSIGNED type data has positive integers as values. The range is between 0 and 2^n-1 . The data is shown by the bit sequence of length n.



Please note that the bit sequence starts on the left with the least significant byte.

Example: Value 266 = 10A hex of type UNSIGNED16 is transmitted on the bus in two octets, first 0A hex and then 01 hex.

SIGNED type data has integers as values. The range is between -2^{n-1} and $2^{n-1}-1$. The data is shown by the bit sequence of length n.



Please note that the bit sequence starts on the left with the least significant byte.

Example: The value -266 = FEF6 hex of type SIGNED16 is transmitted in two octets, first F6 hex and then FE hex.

7.2.3 Modbus Protocol

Modbus is a serial communications protocol published by Modicon in 1979 for use with its programmable logic controllers (PLCs). It has become a de facto standard communications protocol in industry, and is now the most commonly available means of connecting industrial electronic devices. The Woodward controller sup-

ports a Modbus RTU Slave module. This means that a Master node needs to poll the controller slave node. Modbus RTU can also be multi-dropped, or in other words, multiple Slave devices can exist on one Modbus RTU network, assuming that the serial interface is a RS-485.

Detailed information about the Modbus protocol is available on the following website:

- <http://www.modbus.org/specs.php>

There are also various tools available on the internet. We recommend using ModScan32 which is a Windows application designed to operate as a Modbus Master device for accessing data points in a connected Modbus Slave device. It is designed primarily as a testing device for verification of correct protocol operation in new or existing systems.

A trial version download is available from the following website:

- <http://www.win-tech.com/html/modscan32.htm>

Address range

The controller Modbus Slave module distinguishes between visualization data and configuration & remote control data. The different data is accessible over a split address range and can be read via the "Read Holding Register" function.

Furthermore, controller parameters and remote control data can be written with the "Preset Single Registers" function or "Preset Multiple Registers" (Fig. 163)

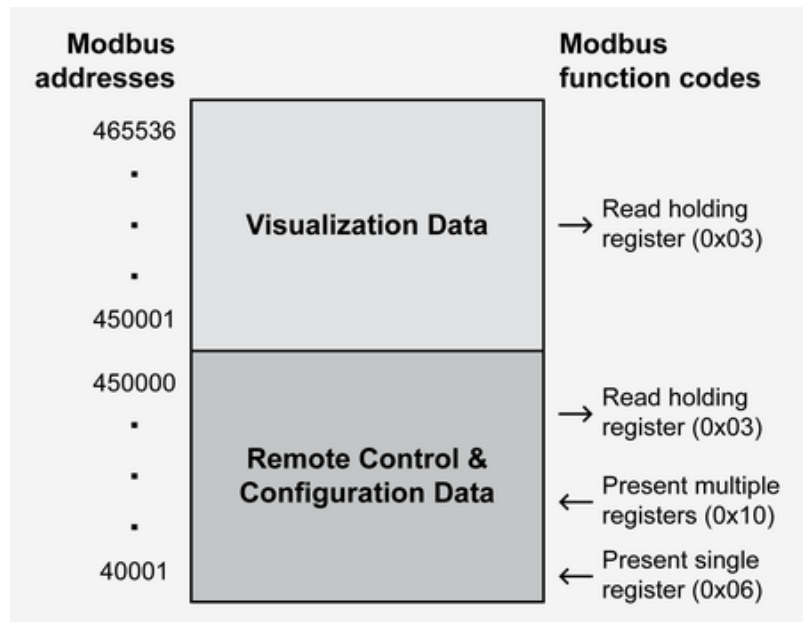

Fig. 163: Address range



All addresses in this document comply with the Modicon address convention. Some PLCs or PC programs use different address conventions depending on their implementation. Then the address must be increased and the leading 4 may be omitted.

Please refer to your PLC or program manual for more information. This determines the address sent over the bus in the Modbus telegram. The Modbus starting address 450001 of the visualization data may become bus address 50000 for example.

Visualization

The visualization over Modbus is provided in a very fast data protocol where important system data like alarm states, AC measurement data, switch states and various other information may be polled.

According to the Modbus addressing range, the visualization protocol can be reached on addresses starting at 450001. On this address range it is possible to do block reads from 1 up to 128 Modbus registers at a time.

Modbus read addresses	Description	Multiplier	Units
450001	Protocol-ID, always 5300		–
450002	Scaling Power (16 bits) Exponent 10x W (5;4;3;2)		
.....
.....
.....
.....
450250	System B voltage L3-N	0.1	V

Table 41: Address range block read



↪ Table 41 “Address range block read” on page 262 is only an excerpt of the data protocol. It conforms to the data protocol 5300.

Refer to ↪ Chapter 9.2.2.1 “Data Protocol 5300 (Basic Visualization)” on page 312 for the complete protocol.

The following ModScan32 screenshot shows the configurations made to read the visualization protocol with a block read of 128 registers.

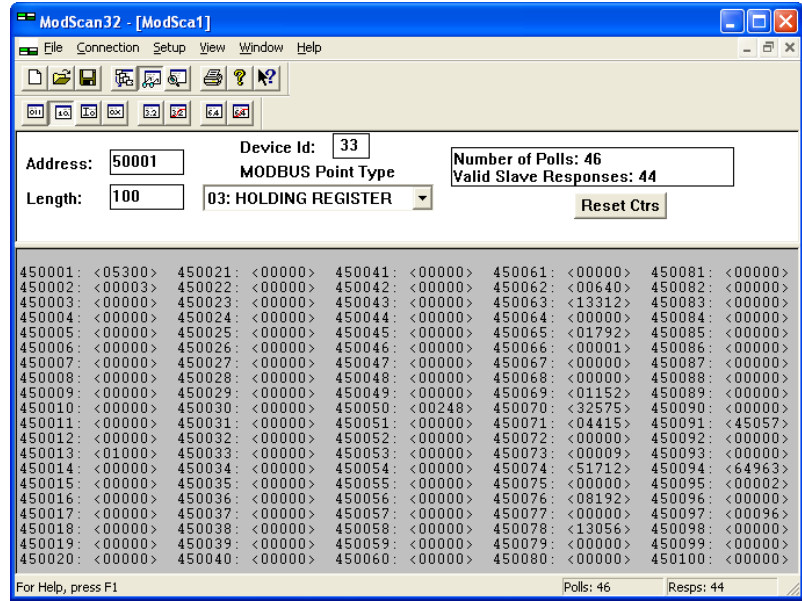

Fig. 164: Visualization configurations

Configuration

The Modbus interface can be used to read/write parameters. According the Modbus addressing range for the configuration addresses, the range starts at 40001 and ends at 450000. You can always access only one parameter of the system in this address range. The Modbus address can be calculated depending on the parameter ID as illustrated below:

	Parameter ID < 10000	Parameter ID >= 10000
Modbus address =	40000 + (Par. ID+1)	400000 + (Par. ID+1)

Table 42: Address calculation

Block reads in this address range depend on the data type of the parameter. This makes it important to set the correct length in Modbus registers which depends on the data type (UNSIGNED 8, INTEGER 16, etc.).

Types	Modbus registers
UNSIGNED 8	1
UNSIGNED 16	1
INTEGER 16	1
UNSIGNED 32	2
INTEGER 32	2
LOGMAN	7
TEXT/X	X/2

Table 43: Data types

Address length example

Parameter 1766 SyA. rated voltage is a two byte data type, parameter 1754 SyA. rated current is a one byte data type:

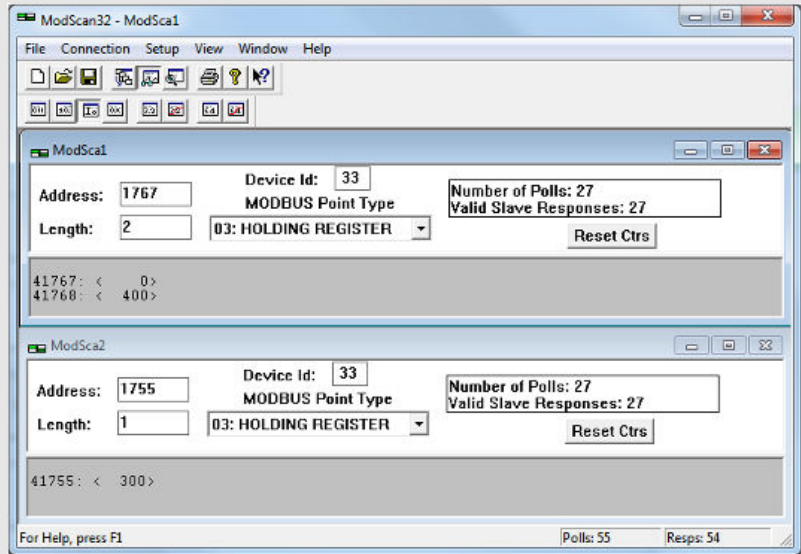

Fig. 165: ModScan to handle 1 and 2 bytes data types

8 Technical Specifications

8.1 Technical Data

Product label

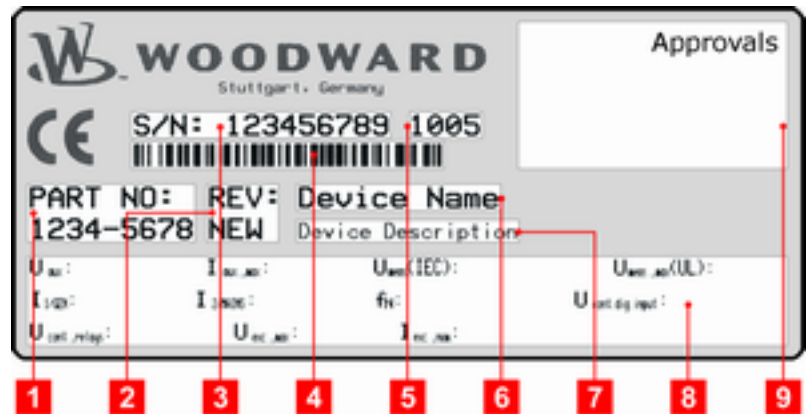

Fig. 166: Product label

1	P/N	Item number
2	REV	Item revision number
3	S/N	Serial number (numerical)
4	S/N	Serial number (barcode)
5	S/N	Date of production (year-month)
6	Type	Description (short)
7	Type	Description (long)
8	Details	Technical data
9	Approval	Approvals

8.1.1 Measuring Values

Voltages

Measuring voltage /	120 V	
Rated value (V_{rated})		69/120 Vac
Maximum value (V_{max})		max. 86/150 Vac
Rated voltage phase – ground		150 Vac
Rated surge voltage (V_{surge})		2.5 kV
Measuring voltage /	480 V	
Rated value (V_{rated})		277/480 Vac
Maximum value (V_{max})		max. 346/600 Vac
Rated voltage phase – ground		300 Vac
Rated surge voltage (V_{surge})		4.0 kV
Linear measuring range		$1.25 \times V_{rated}$
Measuring frequency		50/60 Hz (30.0 to 85.0 Hz)
Accuracy		Class 1

Input resistance per path	120 V	0.498 MΩ
	480 V	2.0 MΩ

Currents

Measuring inputs		Galvanically isolated
Measuring current	[1] Rated value (I_{rated})	../1 A
	[5] Rated value (I_{rated})	../5 A
Accuracy	Class 1	≤1% of full scale
Linear measuring range	System A	approx. $1.5 \times I_{rated}$
Measuring frequency		50/60 Hz (40 to 85 Hz)
Maximum power consumption per path	< 0.15 VA	
Rated short-time current (1 s)	[1]	$50.0 \times I_{rated}$
	[5]	$10.0 \times I_{rated}$

8.1.2 Ambient Variables

Power supply	12/24 Vdc (8 to 40.0 Vdc)
Intrinsic consumption	LS-511: ~ 5 W
	LS-521: ~ 6 W
Degree of pollution	2
Maximum elevation	2,000 m ASL
Overvoltage (≤ 2 min)	80 Vdc
Reverse voltage protection	Full supply range
Input capacitance	LS-511: 660 μF
	LS-521: 660 μF

8.1.3 Inputs/Outputs

Discrete inputs

Discrete inputs	Galvanically isolated
Input range (Vcont. dig. input)	Rated voltage 12/24 Vdc (8 to 40.0 Vdc)
Input resistance	approx. 20 kΩ

Discrete outputs

Discrete outputs		Potential free
Contact material		AgCdO
General purpose (GP) ($V_{cont. relays}$)	AC	2.00 Aac@250 Vac
		2.00 Adc@24 Vdc
	DC	0.36 Adc@125 Vdc
		0.18 Adc@250 Vdc

Pilot duty (PD) ($V_{cont, relays}$)	AC	B300
	DC	1.00 Adc@24 Vdc
		0.22 Adc@125 Vdc
		0.10 Adc@250 Vdc

8.1.4 Interface

Service Port interface (RS232/USB)

Service Port interface	Not isolated
Proprietary interface	Connect only with Woodward DPC cable

RS-485 interface

RS-485 interface	Galvanically isolated
Insulation voltage (continuously)	100 Vac
Insulation test voltage (≤ 5 s)	1000 Vac
Version	RS-485 Standard
Operation	Half-duplex
Data rate	up to 150 kBaud

CAN bus interface

CAN bus interface	Galvanically isolated
Insulation voltage (continuously)	100 Vac
Insulation test voltage (≤ 5 s)	1000 Vac
Version	CAN bus
Internal line termination	Not available

8.1.5 Battery

Battery inside



Fig. 167: Waste Disposal

This device contains a battery, and therefore it is labeled with the symbol shown beside according to the EU Directive 2006/66/EC.



WARNING!

Batteries can be harmful to the environment. Damaged or unusable batteries must be disposed of in a container specially reserved for this purpose.

In general, appropriate local guidelines and regulations must be followed when disposing of electrical devices and batteries.

Type	Lithium
Life span (operation without power supply)	approx. 5 years
Battery field replacement	Not allowed

Technical Specifications

Environmental Data

8.1.6 Housing

Housing type

Type	Plastic	easYpack
	Sheet metal	Custom
Dimensions (W × H × D)	Plastic	219 × 171 × 61 mm
	Sheet metal	190 × 167 × 47 mm
Front cutout (W × H)	Plastic	186 [+1.1] × 138 [+1.0] mm
Wiring	Screw-plug-terminals	2.5 mm ²
Recommended locked torque	4 inch pounds / 0.5 Nm Use 60/75 °C copper wire only Use class 1 wire only or equivalent	
Weight	Plastic	approx. 850 g
	Sheet metal	approx. 840 g

Protection

Protection system	Plastic	IP54 from front with clamp fasteners
		IP66 from front with screw kit
		IP20 from back
	Sheet metal	IP20
Front foil (plastic housing)		Insulating surface

8.1.7 Approvals

EMC test (CE)	Tested according to applicable EN guidelines	
Listings	CE marking	
	UL / cUL, Ordinary Locations, File No.: 231544	
Marine	Type approval	Pending: Lloyds Register (LR)
	Design assessment	Pending: American Bureau of Shipping (ABS)

8.1.8 Generic Note

Accuracy	Referred to full scale value
----------	------------------------------

8.2 Environmental Data

Vibration

Frequency range - sine sweep	5 Hz to 100 Hz
Acceleration	4 G
Standards	EN 60255-21-1 (EN 60068-2-6, Fc)
	Lloyd's Register, Vibration Test2
	SAEJ1455 Chassis Data
Frequency range - random	10 Hz to 500 Hz

Power intensity	0.015 G ² /Hz
RMS value	1.04 Grms
Standards	MIL-STD 810F, M514.5A, Cat.4,
	Truck/Trailer tracked-restrained
	Cargo, Fig. 514.5-C1

Shock

Shock	40 G, Saw tooth pulse, 11 ms
Standards	EN 60255-21-2
	MIL-STD 810F, M516.5, Procedure 1

Temperature

Cold, Dry Heat (storage)	-30 °C (-22 °F) / 80 °C (176 °F)
Cold, Dry Heat (operating)	-20 °C (-4 °F) / 70 °C (158 °F)
Standards	IEC 60068-2-2, Test Bb and Bd
	IEC 60068-2-1, Test Ab and Ad
	MILSTD -810D, M501.2 Induced, M502.2 Cold
	LR Dry Heat, Cold, Env't 2,4, DNV Dry heat, Cold Class A,C

Humidity

Humidity	95%, non condensing
Standards	MIL-STD 810D, M507.2, PII

Marine environmental categories

Marine environmental categories	Lloyd's Register of Shipping (LRS): ENV1, ENV2, ENV3 and ENV4
---------------------------------	---

8.3 Accuracy

Measuring value	Display	Accuracy	Measuring start	Notes
Frequency				
System A	40.0 to 85.0 Hz	0.1 % (of 85 Hz)	5 % (of PT secondary voltage setting) ¹	
System B				
Voltage				
Wye system A / system A	0 to 650 kV	1 % (of 120/480 V) ²	1.5 % (of PT secondary voltage setting) ¹	
Delta system A / system B				2 % (of PT secondary voltage setting) ¹
Current				
System A	0 to 32,000 A	1 % (of 1/5 A) ³	1 % (of 1/5 A) ³	
Max. value				
Real power				
Actual total real power value	-2 to 2 GW	2 % (of 120/480 V * 1/5 A) ^{2/3}	Measuring starts when voltage is recognized	

Technical Specifications

Accuracy

Measuring value	Display	Accuracy	Measuring start	Notes
Reactive power				
Actual value in L1, L2, L3	-2 to 2 Gvar	2 % (of 120/480 V * 1/5 A) ^{2/3}	Measuring starts when voltage is recognized	
Power factor				
Actual value power factor L1	lagging 0.00 to 1.00 to leading 0.00	2 %	2 % (of 1/5 A) ³	1.00 is displayed for measuring values below the measuring start
Miscellaneous				
Battery voltage	8 to 40 V	1 % (of 24 V)		
Phase angle	-180 to 180 °		1.25 % (of PT secondary volt. setting)	180 ° is displayed for measuring values below measuring start



¹ Setting of the parameter for the PT secondary rated voltage

² Depending on the used measuring inputs (120/480 V)

³ Depending on the CT input hardware (1/5 A) of the respective unit

Reference conditions



The reference conditions for measuring the accuracy are listed below.

Input voltage	Sinusoidal rated voltage
Input current	Sinusoidal rated current
Frequency	Rated frequency +/- 2 %
Power supply	Rated voltage +/- 2 %
Power factor (cos φ)	1.00
Ambient temperature	23 °C +/- 2 K
Warm-up period	20 minutes

9 Appendix

9.1 Characteristics

9.1.1 Triggering Characteristics

Two-level overshoot monitoring

The following monitors use this triggering characteristic: System A overvoltage, System A overfrequency, Battery overvoltage, ...

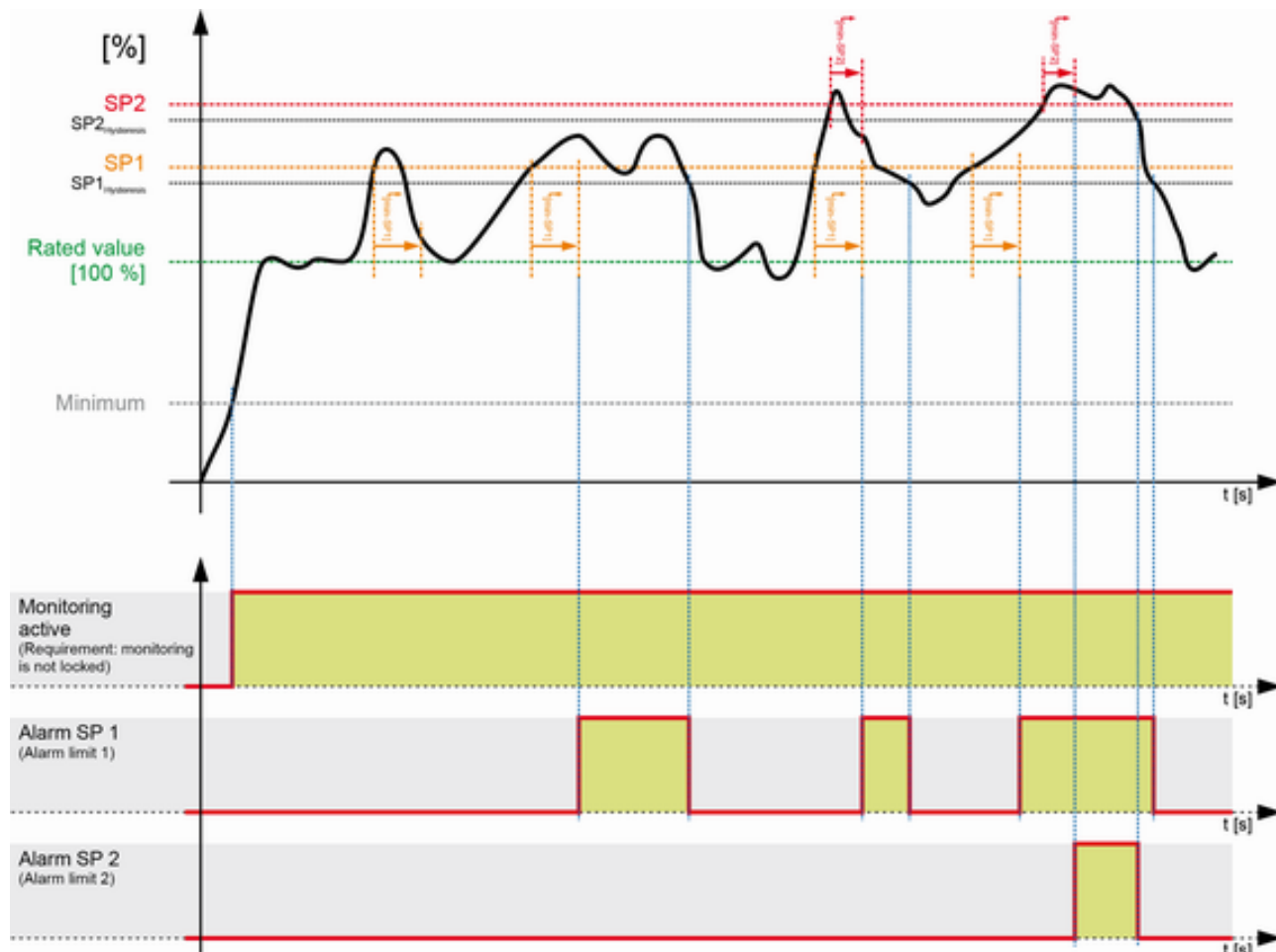

Fig. 168: Two-level overshoot monitoring

Two-level undershoot monitoring

The following monitors use this triggering characteristic: System A undervoltage, System A underfrequency, Battery undervoltage, ...

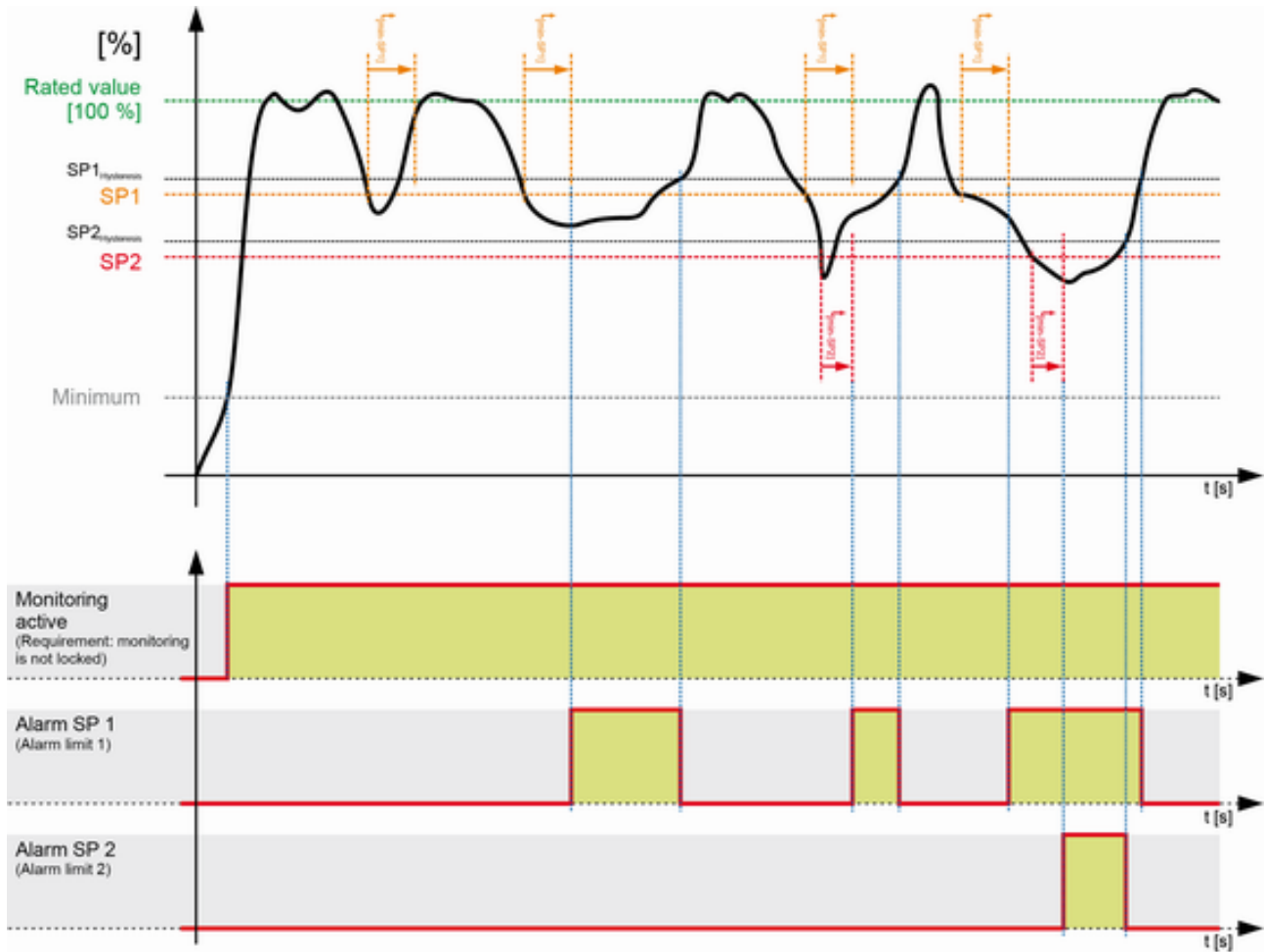

Fig. 169: Two-level undershoot monitoring

One-level asymmetry monitoring

The following monitors use this triggering characteristic: System A voltage asymmetry.

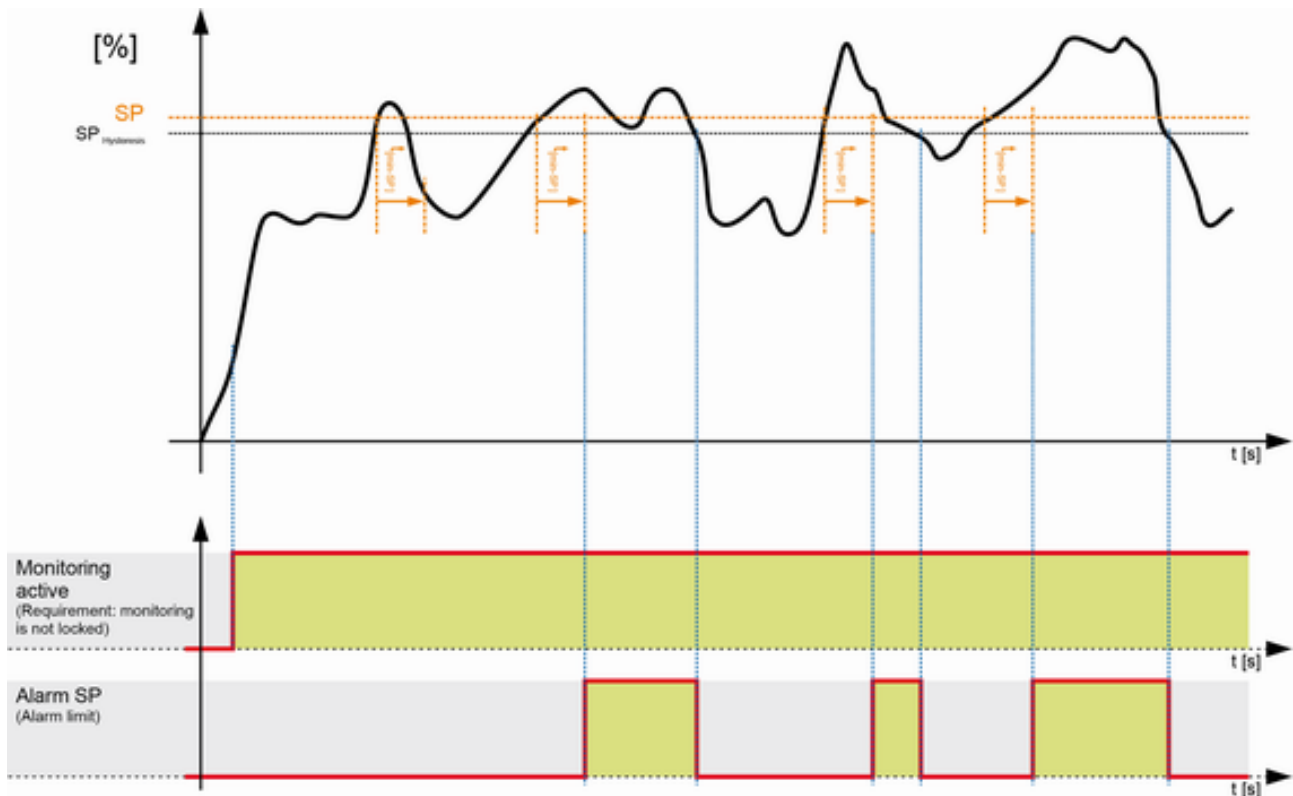

Fig. 170: One-level asymmetry monitoring

9.2 Data Protocols

9.2.1 CANopen

9.2.1.1 Data Protocol 5301 (Basic Visualization)

CAN	Param-eter ID		Description	Multiplier	Units	Model
	Data byte 0 (Mux)	Data byte				
0	1,2		Protocol ID, always 5301			LS-5x1 v2, LS-5x2 v2
0	3,4,5,6	136	System A total reactive power	1	Var	LS-5x1 v2, LS-5x2 v2
1	1,2	160	System A power factor (cos.phi)	0.001		LS-5x1 v2, LS-5x2 v2
1	3,4,5,6	170	System A average wye voltage	0.1	V	LS-5x1 v2, LS-5x2 v2
2	1,2	144	System A frequency	0.01	Hz	LS-5x1 v2, LS-5x2 v2
2	3,4,5,6	171	System A average delta voltage	0.1	V	LS-5x1 v2, LS-5x2 v2

Appendix

Data Protocols > CANopen > Data Protocol 5301 (Basic ...

CAN		Parameter ID	Description	Multiplier	Units	Model
Data byte 0 (Mux)	Data byte					
3	1,2	10202	Operation modes 13280 = CB A request 13264 = Unloading CB A 13210 = CB A Dead bus closure 13260 = Synchronization CB A 13205 = Mains settling time running 13257 = Open CB A 13279 = Synchronization network close CB A 13265 = Synchronization PERMISSIVE 13266 = Synchronization CHECK 13267 = Synchronization OFF 13286 = Synchronization segments close CB A The following operation modes are supported by the LS-5x2 v2 only: 13256 = Unloading CB B 13261 = CB B - CB A delay 13262 = CB A - CB B delay 13259 = Synchronization CB B 13255 = Open CB B 13340 = CB B request 13209 = CB B Dead bus closure			LS-5x1 v2, LS-5x2 v2
3	3,4,5,6	337	System A total active power AC measurement	1	W	LS-5x1 v2, LS-5x2 v2
4	1,2	10107	Discrete outputs 1 to 6			
			Relay-Output 1 (inverted)	Mask: 8000h	Bit	LS-5x1 v2, LS-5x2 v2
			Relay-Output 2	Mask: 4000h	Bit	LS-5x1 v2, LS-5x2 v2
			Relay-Output 3	Mask: 2000h	Bit	LS-5x1 v2, LS-5x2 v2
			Relay-Output 4	Mask: 1000h	Bit	LS-5x1 v2, LS-5x2 v2
			Relay-Output 5	Mask: 0800h	Bit	LS-5x1 v2, LS-5x2 v2
			Relay-Output 6	Mask: 0400h	Bit	LS-5x1 v2, LS-5x2 v2
			internal	Mask: 0200h	Bit	
			internal	Mask: 0100h	Bit	
			internal	Mask: 0080h	Bit	
			internal	Mask: 0040h	Bit	
			internal	Mask: 0020h	Bit	
			internal	Mask: 0010h	Bit	
			internal	Mask: 0008h	Bit	
			internal	Mask: 0004h	Bit	

CAN		Param- eter ID	Description	Multiplier	Units	Model
Data byte 0 (Mux)	Data byte					
			internal	Mask: 0002h	Bit	
			internal	Mask: 0001h	Bit	
4	3,4,5,6	185	System A current average	0.001	A	LS-5x1 v2, LS-5x2 v2
5	1,2	8018	internal	Mask: 0001h	Bit	
			internal	Mask: 0002h	Bit	
			internal	Mask: 0004h	Bit	
			internal	Mask: 0008h	Bit	
			internal	Mask: 0010h	Bit	
			internal	Mask: 0020h	Bit	
			internal	Mask: 0040h	Bit	
			internal	Mask: 0080h	Bit	
			28.01 Command to CB-control 1 (OR'ed)	Mask: 0100h	Bit	LS-5x1 v2, LS-5x2 v2
			28.02 Command to CB-control 2 (OR'ed)	Mask: 0200h	Bit	LS-5x1 v2, LS-5x2 v2
			28.03 Command to CB-control 3 (OR'ed)	Mask: 0400h	Bit	LS-5x1 v2, LS-5x2 v2
			28.04 Command to CB-control 4 (OR'ed)	Mask: 0800h	Bit	LS-5x1 v2, LS-5x2 v2
			28.05 Command to CB-control 5 (OR'ed)	Mask: 1000h	Bit	LS-5x1 v2, LS-5x2 v2
			28.06 Command to CB-control 6 (OR'ed)	Mask: 2000h	Bit	LS-5x1 v2, LS-5x2 v2
internal	Mask: 4000h	Bit				
internal	Mask: 8000h	Bit				
5	3,4,5,6	111	System A current 1	0.001	A	LS-5x1 v2, LS-5x2 v2
6	1,2	10110	Battery voltage	0.1	V	LS-5x1 v2, LS-5x2 v2
6	3,4,5,6	112	System A current 2	0.001	A	LS-5x1 v2, LS-5x2 v2
7	1,2	10146	internal	Mask: 0001h	Bit	
			internal	Mask: 0002h	Bit	
			internal	Mask: 0004h	Bit	
			11.07 Active second	Mask: 0008h	Bit	LS-5x1 v2, LS-5x2 v2
			11.06 Active minute	Mask: 0010h	Bit	LS-5x1 v2, LS-5x2 v2
			11.05 Active hour	Mask: 0020h	Bit	LS-5x1 v2, LS-5x2 v2
			11.04 Active day in month	Mask: 0040h	Bit	LS-5x1 v2, LS-5x2 v2
			11.03 Active weekday	Mask: 0080h	Bit	LS-5x1 v2, LS-5x2 v2

Appendix

Data Protocols > CANopen > Data Protocol 5301 (Basic ...

CAN		Parameter ID	Description	Multiplier	Units	Model
Data byte 0 (Mux)	Data byte					
			11.02 Time 2 overrun	Mask: 0100h	Bit	LS-5x1 v2, LS-5x2 v2
			11.01 Time 1 overrun	Mask: 0200h	Bit	LS-5x1 v2, LS-5x2 v2
			internal	Mask: 0400h	Bit	
			04.05 Acknowledge was executed	Mask: 0800h	Bit	LS-5x1 v2, LS-5x2 v2
			01.09 Shutdown alarm active (alarm C-F)	Mask: 1000h	Bit	LS-5x1 v2, LS-5x2 v2
			internal	Mask: 2000h	Bit	
			internal	Mask: 4000h	Bit	
			internal	Mask: 8000h	Bit	
7	3,4,5,6	113	System A current 3	0.001	A	LS-5x1 v2, LS-5x2 v2
8	1,2	10107	00.41 LM Relay 1	Mask: 8000h	Bit	LS-5x1 v2, LS-5x2 v2
			00.42 LM Relay 2	Mask: 4000h	Bit	LS-5x1 v2, LS-5x2 v2
			00.43 LM Relay 3	Mask: 2000h	Bit	LS-5x1 v2, LS-5x2 v2
			00.44 LM Relay 4	Mask: 1000h	Bit	LS-5x1 v2, LS-5x2 v2
			00.45 LM Relay 5	Mask: 0800h	Bit	LS-5x1 v2, LS-5x2 v2
			00.46 LM Relay 6	Mask: 0400h	Bit	LS-5x1 v2, LS-5x2 v2
			internal	Mask: 0200h	Bit	
			internal	Mask: 0100h	Bit	
			internal	Mask: 0080h	Bit	
			internal	Mask: 0040h	Bit	
			internal	Mask: 0020h	Bit	
			internal	Mask: 0010h	Bit	
			internal	Mask: 0008h	Bit	
			internal	Mask: 0004h	Bit	
			internal	Mask: 0002h	Bit	
internal	Mask: 0001h	Bit				
8	3,4,5,6	108	System A voltage L1-L2	0.1	V	LS-5x1 v2, LS-5x2 v2
9	1,2	10140	00.01 LM Internal flag 1	Mask: 8000h	Bit	LS-5x1 v2, LS-5x2 v2
			00.02 LM Internal flag 2	Mask: 4000h	Bit	LS-5x1 v2, LS-5x2 v2
			00.03 LM Internal flag 3	Mask: 2000h	Bit	LS-5x1 v2, LS-5x2 v2

CAN		Param- eter ID	Description	Multiplier	Units	Model
Data byte 0 (Mux)	Data byte					
			00.04 LM Internal flag 4	Mask: 1000h	Bit	LS-5x1 v2, LS-5x2 v2
			00.05 LM Internal flag 5	Mask: 0800h	Bit	LS-5x1 v2, LS-5x2 v2
			00.06 LM Internal flag 6	Mask: 0400h	Bit	LS-5x1 v2, LS-5x2 v2
			00.07 LM Internal flag 7	Mask: 0200h	Bit	LS-5x1 v2, LS-5x2 v2
			00.08 LM Internal flag 8	Mask: 0100h	Bit	LS-5x1 v2, LS-5x2 v2
			internal	Mask: 0080h	Bit	
			internal	Mask: 0040h	Bit	
			internal	Mask: 0020h	Bit	
			00.15 LM External acknowledge	Mask: 0010h	Bit	LS-5x1 v2, LS-5x2 v2
			internal	Mask: 0008h	Bit	
			00.16 LM Operation mode AUTOMATIC	Mask: 0004h	Bit	LS-5x1 v2, LS-5x2 v2
			00.17 LM Operation mode MANUAL	Mask: 0002h	Bit	LS-5x1 v2, LS-5x2 v2
			internal	Mask: 0001h	Bit	
9	3,4,5,6	114	System A voltage L1-N	0.1	V	LS-5x1 v2, LS-5x2 v2
10	1,2	10148	internal	Mask: 8000h	Bit	
			internal	Mask: 4000h	Bit	
			internal	Mask: 2000h	Bit	
			internal	Mask: 1000h	Bit	
			04.04 Lamp test	Mask: 0800h	Bit	LS-5x1 v2, LS-5x2 v2
			01.10 Centralized alarms active (alarm B-F)	Mask: 0400h	Bit	LS-5x1 v2, LS-5x2 v2
			01.07 All alarm classes are active	Mask: 0200h	Bit	LS-5x1 v2, LS-5x2 v2
			01.08 Warning alarms active (alarm A, B)	Mask: 0100h	Bit	LS-5x1 v2, LS-5x2 v2
			internal	Mask: 0080h	Bit	
			internal	Mask: 0040h	Bit	
			internal	Mask: 0020h	Bit	
			internal	Mask: 0010h	Bit	
			internal	Mask: 0008h	Bit	
			internal	Mask: 0004h	Bit	
			internal	Mask: 0002h	Bit	
internal	Mask: 0001h	Bit				

Appendix

Data Protocols > CANopen > Data Protocol 5301 (Basic ...

CAN		Parameter ID	Description	Multiplier	Units	Model
Data byte 0 (Mux)	Data byte					
10	3,4,5,6	109	System A voltage L2-L3	0.1	V	LS-5x1 v2, LS-5x2 v2
11	1,2	10150	internal	Mask: 8000h	Bit	
			internal	Mask: 4000h	Bit	
			internal	Mask: 2000h	Bit	
			internal	Mask: 1000h	Bit	
			internal	Mask: 0800h	Bit	
			internal	Mask: 0400h	Bit	
			00.30 LM Internal flag 9	Mask: 0200h	Bit	LS-5x1 v2, LS-5x2 v2
			00.31 LM Internal flag 10	Mask: 0100h	Bit	LS-5x1 v2, LS-5x2 v2
			00.32 LM Internal flag 11	Mask: 0080h	Bit	LS-5x1 v2, LS-5x2 v2
			00.33 LM Internal flag 12	Mask: 0040h	Bit	LS-5x1 v2, LS-5x2 v2
			00.34 LM Internal flag 13	Mask: 0020h	Bit	LS-5x1 v2, LS-5x2 v2
			00.35 LM Internal flag 14	Mask: 0010h	Bit	LS-5x1 v2, LS-5x2 v2
			00.36 LM Internal flag 15	Mask: 0008h	Bit	LS-5x1 v2, LS-5x2 v2
			00.37 LM Internal flag 16	Mask: 0004h	Bit	LS-5x1 v2, LS-5x2 v2
			internal	Mask: 0002h	Bit	
internal	Mask: 0001h	Bit				
11	3,4,5,6	115	System A voltage L2-N	0.1	V	LS-5x1 v2, LS-5x2 v2
12	1,2	10160	internal	Mask: 8000h	Bit	
			internal	Mask: 4000h	Bit	
			internal	Mask: 2000h	Bit	
			internal	Mask: 1000h	Bit	
			internal	Mask: 0800h	Bit	
			internal	Mask: 0400h	Bit	
			internal	Mask: 0200h	Bit	
			internal	Mask: 0100h	Bit	
			internal	Mask: 0080h	Bit	
			internal	Mask: 0040h	Bit	
			internal	Mask: 0020h	Bit	
			internal	Mask: 0010h	Bit	
			internal	Mask: 0008h	Bit	
			internal	Mask: 0004h	Bit	

CAN		Parameter ID	Description	Multiplier	Units	Model
Data byte 0 (Mux)	Data byte					
			01.11 New alarm triggered	Mask: 0002h	Bit	LS-5x1 v2, LS-5x2 v2
			internal	Mask: 0001h	Bit	
12	3,4,5,6	110	System A voltage L3-L1	0.1	V	LS-5x1 v2, LS-5x2 v2
13	1,2	10162	internal	Mask: 8000h	Bit	
			internal	Mask: 4000h	Bit	
			internal	Mask: 2000h	Bit	
			internal	Mask: 1000h	Bit	
			internal	Mask: 0800h	Bit	
			internal	Mask: 0400h	Bit	
			internal	Mask: 0200h	Bit	
			internal	Mask: 0100h	Bit	
			internal	Mask: 0080h	Bit	
			internal	Mask: 0040h	Bit	
			internal	Mask: 0020h	Bit	
			internal	Mask: 0010h	Bit	
			internal	Mask: 0008h	Bit	
			00.38 LM Synchronization mode CHECK	Mask: 0004h	Bit	LS-5x1 v2, LS-5x2 v2
00.39 LM Synchronization mode PERMISSIVE	Mask: 0002h	Bit	LS-5x1 v2, LS-5x2 v2			
00.40 LM Synchronization mode RUN	Mask: 0001h	Bit	LS-5x1 v2, LS-5x2 v2			
13	3,4,5,6	116	System A voltage L3-N	0.1	V	LS-5x1 v2, LS-5x2 v2
14	1,2	10131	internal	Mask: 8000h	Bit	
			internal	Mask: 4000h	Bit	
			internal	Mask: 2000h	Bit	
			internal	Mask: 1000h	Bit	
			internal	Mask: 0800h	Bit	
			internal	Mask: 0400h	Bit	
			internal	Mask: 0200h	Bit	
			internal	Mask: 0100h	Bit	
			internal	Mask: 0080h	Bit	
			internal	Mask: 0040h	Bit	
			Alarm class F latched	Mask: 0020h	Bit	LS-5x1 v2, LS-5x2 v2
			Alarm class E latched	Mask: 0010h	Bit	LS-5x1 v2, LS-5x2 v2

Appendix

Data Protocols > CANopen > Data Protocol 5301 (Basic ...

CAN		Parameter ID	Description	Multiplier	Units	Model
Data byte 0 (Mux)	Data byte					
			Alarm class D latched	Mask: 0008h	Bit	LS-5x1 v2, LS-5x2 v2
			Alarm class C latched	Mask: 0004h	Bit	LS-5x1 v2, LS-5x2 v2
			Alarm class B latched	Mask: 0002h	Bit	LS-5x1 v2, LS-5x2 v2
			Alarm class A latched	Mask: 0001h	Bit	LS-5x1 v2, LS-5x2 v2
14	3,4,5,6	2520	System A positive active energy	0.01	MWh	LS-5x1 v2, LS-5x2 v2
15	1,2	10132	State Discrete Input 8 latched	Mask: 8000h	Bit	LS-5x1 v2, LS-5x2 v2
			State Discrete Input 7 latched	Mask: 4000h	Bit	LS-5x1 v2, LS-5x2 v2
			State Discrete Input 6 latched	Mask: 2000h	Bit	LS-5x1 v2, LS-5x2 v2
			State Discrete Input 5 latched	Mask: 1000h	Bit	LS-5x1 v2, LS-5x2 v2
			State Discrete Input 4 latched	Mask: 0800h	Bit	LS-5x1 v2, LS-5x2 v2
			State Discrete Input 3 latched	Mask: 0400h	Bit	LS-5x1 v2, LS-5x2 v2
			State Discrete Input 2 latched	Mask: 0200h	Bit	LS-5x1 v2, LS-5x2 v2
			State Discrete Input 1 latched	Mask: 0100h	Bit	LS-5x1 v2, LS-5x2 v2
			internal	Mask: 0080h	Bit	
			internal	Mask: 0040h	Bit	
			internal	Mask: 0020h	Bit	
			internal	Mask: 0010h	Bit	
			internal	Mask: 0008h	Bit	
			internal	Mask: 0004h	Bit	
internal	Mask: 0002h	Bit				
internal	Mask: 0001h	Bit				
15	3,4,5,6	173	System B average wye voltage	0.1	V	LS-5x1 v2, LS-5x2 v2
16	1,2	147	System B frequency	0.01	Hz	LS-5x1 v2, LS-5x2 v2
16	3,4,5,6	174	System B average delta voltage	0.1	V	LS-5x1 v2, LS-5x2 v2
17	1,2	10111	Analog input 1	-	-	LS-5x2 v2
17	3,4,5,6	207	System B average current	0.001	A	LS-5x2 v2
18	1,2	208	System B power factor	0.001	-	LS-5x2 v2
18	3,4,5,6	338	System B total active power AC measurement	1	W	LS-5x2 v2
19	1,2	10137	internal	Mask: 8000h	Bit	
			internal	Mask: 4000h	Bit	

CAN		Parameter ID	Description	Multiplier	Units	Model
Data byte 0 (Mux)	Data byte					
			internal	Mask: 2000h	Bit	
			internal	Mask: 1000h	Bit	
			internal	Mask: 0800h	Bit	
			internal	Mask: 0400h	Bit	
			internal	Mask: 0200h	Bit	
			internal	Mask: 0100h	Bit	
			internal	Mask: 0080h	Bit	
			internal	Mask: 0040h	Bit	
			internal	Mask: 0020h	Bit	
			internal	Mask: 0010h	Bit	
			internal	Mask: 0008h	Bit	
			internal	Mask: 0004h	Bit	
			10.01 Analog input 1, wire break	Mask: 0002h	Bit	LS-5x2 v2
			internal	Mask: 0001h	Bit	
19	3,4,5,6	150	System B total reactive power	1	var	LS-5x2 v2
20	1,2	534	04.59 Remote control bit 16	Mask: 8000h	Bit	LS-5x1 v2, LS-5x2 v2
			04.58 Remote control bit 15	Mask: 4000h	Bit	LS-5x1 v2, LS-5x2 v2
			04.57 Remote control bit 14	Mask: 2000h	Bit	LS-5x1 v2, LS-5x2 v2
			04.56 Remote control bit 13	Mask: 1000h	Bit	LS-5x1 v2, LS-5x2 v2
			04.55 Remote control bit 12	Mask: 0800h	Bit	LS-5x1 v2, LS-5x2 v2
			04.54 Remote control bit 11	Mask: 0400h	Bit	LS-5x1 v2, LS-5x2 v2
			04.53 Remote control bit 10	Mask: 0200h	Bit	LS-5x1 v2, LS-5x2 v2
			04.52 Remote control bit 9	Mask: 0100h	Bit	LS-5x1 v2, LS-5x2 v2
			04.51 Remote control bit 8	Mask: 0080h	Bit	LS-5x1 v2, LS-5x2 v2
			04.50 Remote control bit 7	Mask: 0040h	Bit	LS-5x1 v2, LS-5x2 v2
			04.49 Remote control bit 6	Mask: 0020h	Bit	LS-5x1 v2, LS-5x2 v2
			04.48 Remote control bit 5	Mask: 0010h	Bit	LS-5x1 v2, LS-5x2 v2
			04.47 Remote control bit 4	Mask: 0008h	Bit	LS-5x1 v2, LS-5x2 v2
			04.46 Remote control bit 3	Mask: 0004h	Bit	LS-5x1 v2, LS-5x2 v2
04.45 Remote control bit 2	Mask: 0002h	Bit	LS-5x1 v2, LS-5x2 v2			

Appendix

Data Protocols > CANopen > Data Protocol 5301 (Basic ...

CAN		Parameter ID	Description	Multiplier	Units	Model
Data byte 0 (Mux)	Data byte					
			04.44 Remote control bit 1	Mask: 0001h	Bit	LS-5x1 v2, LS-5x2 v2
20	3,4,5,6	134	System B current 1	0.001	A	LS-5x2 v2
21	1,2	10136	internal	Mask: 8000h	Bit	
			internal	Mask: 4000h	Bit	
			internal	Mask: 2000h	Bit	
			internal	Mask: 1000h	Bit	
			internal	Mask: 0800h	Bit	
			internal	Mask: 0400h	Bit	
			internal	Mask: 0200h	Bit	
			internal	Mask: 0100h	Bit	
			internal	Mask: 0080h	Bit	
			internal	Mask: 0040h	Bit	
			internal	Mask: 0020h	Bit	
			internal	Mask: 0010h	Bit	
			08.02 Battery overvoltage threshold 2	Mask: 0008h	Bit	LS-5x1 v2, LS-5x2 v2
			08.04 Battery undervoltage threshold 2	Mask: 0004h	Bit	LS-5x1 v2, LS-5x2 v2
			08.01 Battery overvoltage threshold 1	Mask: 0002h	Bit	LS-5x1 v2, LS-5x2 v2
08.03 Battery undervoltage threshold 1	Mask: 0001h	Bit	LS-5x1 v2, LS-5x2 v2			
21	3,4,5,6	118	System B voltage L1-L2	0.1	V	LS-5x1 v2, LS-5x2 v2
22	1,2	4139	02.03 System B voltage in range (Based on system B operating voltage window)	Mask: 8000h	Bit	LS-5x1 v2, LS-5x2 v2
			02.04 System B frequency in range (Based on system B operating frequency window)	Mask: 4000h	Bit	LS-5x1 v2, LS-5x2 v2
			02.05 System B voltage and frequency in range (Ready for operation, 02.03 AND 02.04 are TRUE)	Mask: 2000h	Bit	LS-5x1 v2, LS-5x2 v2
			02.09 System A voltage in range (Based on system A voltage window)	Mask: 1000h	Bit	LS-5x1 v2, LS-5x2 v2
			internal	Mask: 0800h	Bit	
			internal	Mask: 0400h	Bit	
			02.10 System A frequency in range (Based on system A frequency window)	Mask: 0200h	Bit	LS-5x1 v2, LS-5x2 v2
			internal	Mask: 0100h	Bit	
			internal	Mask: 0080h	Bit	
			02.11 System A voltage and frequency in range (Ready for operation, 02.09 AND 02.10 are TRUE)	Mask: 0040h	Bit	LS-5x1 v2, LS-5x2 v2

CAN		Param- eter ID	Description	Multiplier	Units	Model
Data byte 0 (Mux)	Data byte					
			internal	Mask: 0020h	Bit	
			internal	Mask: 0010h	Bit	
			internal	Mask: 0008h	Bit	
			internal	Mask: 0004h	Bit	
			internal	Mask: 0002h	Bit	
			internal	Mask: 0001h	Bit	
22	3,4,5,6	121	System B voltage L1-N	0.1	V	LS-5x1 v2, LS-5x2 v2
23	1,2	1791	internal	Mask: 8000h	Bit	
			internal	Mask: 4000h	Bit	
			internal	Mask: 2000h	Bit	
			internal	Mask: 1000h	Bit	
			internal	Mask: 0800h	Bit	
			internal	Mask: 0400h	Bit	
			internal	Mask: 0200h	Bit	
			internal	Mask: 0100h	Bit	
			02.12 System A phase rotation Counter Clock Wise (CCW, reverse, left turn)	Mask: 0080h	Bit	LS-5x1 v2, LS-5x2 v2
			02.13 System A phase rotation Clock Wise (CW, forward, right turn)	Mask: 0040h	Bit	LS-5x1 v2, LS-5x2 v2
			internal	Mask: 0020h	Bit	
			internal	Mask: 0010h	Bit	
			internal	Mask: 0008h	Bit	
			internal	Mask: 0004h	Bit	
internal	Mask: 0002h	Bit				
internal	Mask: 0001h	Bit				
23	3,4,5,6	119	System B voltage L2-L3	0.1	V	LS-5x1 v2, LS-5x2 v2
24	1,2	1792	internal	Mask: 8000h	Bit	
			internal	Mask: 4000h	Bit	
			internal	Mask: 2000h	Bit	
			internal	Mask: 1000h	Bit	
			internal	Mask: 0800h	Bit	
			internal	Mask: 0400h	Bit	
			internal	Mask: 0200h	Bit	
			internal	Mask: 0100h	Bit	

Appendix

Data Protocols > CANopen > Data Protocol 5301 (Basic ...

CAN		Param- eter ID	Description	Multiplier	Units	Model
Data byte 0 (Mux)	Data byte					
			02.14 System B phase rotation Counter Clock Wise (CCW, reverse, left turn)	Mask: 0080h	Bit	LS-5x1 v2, LS-5x2 v2
			02.15 System B phase rotation Clock Wise (CW, forward, right turn)	Mask: 0040h	Bit	LS-5x1 v2, LS-5x2 v2
			internal	Mask: 0020h	Bit	
			internal	Mask: 0010h	Bit	
			internal	Mask: 0008h	Bit	
			internal	Mask: 0004h	Bit	
			internal	Mask: 0002h	Bit	
			internal	Mask: 0001h	Bit	
24	3,4,5,6	122	System B voltage L2-N	0.1	V	LS-5x1 v2, LS-5x2 v2
25	1,2		internal	Mask: 8000h	Bit	
			04.63 Synchr. Segm Closure Pr. is act	Mask: 4000h	Bit	LS-5x1 v2, LS-5x2 v2
			internal	Mask: 2000h	Bit	
			02.28 Synch. Check Relay	Mask: 1000h	Bit	LS-5x1 v2, LS-5x2 v2
			02.29 Synch. Condition	Mask: 0800h	Bit	LS-5x1 v2, LS-5x2 v2
			02.30 Dead Bus Closure Condition	Mask: 0400h	Bit	LS-5x1 v2, LS-5x2 v2
			internal	Mask: 0200h	Bit	
			internal	Mask: 0100h	Bit	
			internal	Mask: 0080h	Bit	
			internal	Mask: 0040h	Bit	
			internal	Mask: 0020h	Bit	
			internal	Mask: 0010h	Bit	
			internal	Mask: 0008h	Bit	
			internal	Mask: 0004h	Bit	
			internal	Mask: 0002h	Bit	
internal	Mask: 0001h	Bit				
25	3,4,5,6	120	System B voltage L3-L1	0.1	V	LS-5x1 v2, LS-5x2 v2
26	1,2	10149	08.30 Timeout synchronization CB B	Mask: 8000h	Bit	LS-5x2 v2
			08.31 Timeout synchronization CB A	Mask: 4000h	Bit	LS-5x1 v2, LS-5x2 v2
			internal	Mask: 2000h	Bit	
			internal	Mask: 1000h	Bit	
			08.33 System A / System B phase rotation mis- match	Mask: 0800h	Bit	LS-5x1 v2, LS-5x2 v2

CAN		Parameter ID	Description	Multiplier	Units	Model
Data byte 0 (Mux)	Data byte					
			reserved	Mask: 0400h	Bit	
			internal	Mask: 0200h	Bit	
			internal	Mask: 0100h	Bit	
			internal	Mask: 0080h	Bit	
			internal	Mask: 0040h	Bit	
			internal	Mask: 0020h	Bit	
			internal	Mask: 0010h	Bit	
			08.17 Number of member mismatch	Mask: 0008h	Bit	LS-5x1 v2, LS-5x2 v2
			05.15 EEPROM corrupted	Mask: 0004h	Bit	LS-5x1 v2, LS-5x2 v2
			internal	Mask: 0002h	Bit	
			internal	Mask: 0001h	Bit	
26	3,4,5,6	123	System B voltage L3-N	0.1	V	LS-5x1 v2, LS-5x2 v2
27	1,2	4153	04.42 Breaker transition mode alternative 2	Mask: 8000h	Bit	LS-5x2 v2
			04.41 Breaker transition mode alternative 1	Mask: 4000h	Bit	LS-5x2 v2
			04.29 Unloading CB A is active	Mask: 2000h	Bit	LS-5x1 v2, LS-5x2 v2
			04.28 Unloading CB B is active	Mask: 1000h	Bit	LS-5x2 v2
			04.23 Close command CB A is active	Mask: 0800h	Bit	LS-5x1 v2, LS-5x2 v2
			04.22 Open command CB A is active	Mask: 0400h	Bit	LS-5x1 v2, LS-5x2 v2
			04.21 Synchronization CB A procedure is active	Mask: 0200h	Bit	LS-5x1 v2, LS-5x2 v2
			04.20 Close command CB B is active	Mask: 0100h	Bit	LS-5x2 v2
			04.19 Open command CB B is active	Mask: 0080h	Bit	LS-5x2 v2
			04.18 Synchronisation CB B procedure is active	Mask: 0040h	Bit	LS-5x2 v2
			04.11 Mains settling is active	Mask: 0020h	Bit	LS-5x1 v2, LS-5x2 v2
			LS-5x1 v2: 24.39 Isolation switch is open	Mask: 0010h	Bit	LS-5x1 v2, LS-5x2 v2
			LS-5x2 v2: 04.06 CB B is closed			
			04.07 CB A is closed	Mask: 0008h	Bit	LS-5x1 v2, LS-5x2 v2
			04.04 Lamp test request	Mask: 0004h	Bit	LS-5x1 v2, LS-5x2 v2
			04.03 Operating mode MANUAL	Mask: 0002h	Bit	LS-5x1 v2, LS-5x2 v2
			04.01 Operating mode AUTOMATIC	Mask: 0001h	Bit	LS-5x1 v2, LS-5x2 v2
27	3,4	4154	02.23 System A is dead	Mask: 8000h	Bit	LS-5x1 v2, LS-5x2 v2

Appendix

Data Protocols > CANopen > Data Protocol 5301 (Basic ...

CAN		Parameter ID	Description	Multiplier	Units	Model
Data byte 0 (Mux)	Data byte					
			02.24 System B is dead	Mask: 4000h	Bit	LS-5x1 v2, LS-5x2 v2
			02.25 Mains parallel operation	Mask: 2000h	Bit	LS-5x1 v2, LS-5x2 v2
			System B mains connected	Mask: 1000h	Bit	LS-5x1 v2, LS-5x2 v2
			System A mains connected	Mask: 0800h	Bit	LS-5x1 v2, LS-5x2 v2
			internal	Mask: 0400h	Bit	
			internal	Mask: 0200h	Bit	
			internal	Mask: 0100h	Bit	
			internal	Mask: 0080h	Bit	
			internal	Mask: 0040h	Bit	
			internal	Mask: 0020h	Bit	
			internal	Mask: 0010h	Bit	
			internal	Mask: 0008h	Bit	
			04.61 Synchronous mains closure procedure is active	Mask: 0004h	Bit	LS-5x1 v2, LS-5x2 v2
			04.62 Dead bus closure procedure is active	Mask: 0002h	Bit	LS-5x1 v2, LS-5x2 v2
			Increment close counter CB A	Mask: 0001h	Bit	LS-5x1 v2, LS-5x2 v2
27	5,6	4155	System B phase rotation CCW (ToolKit)	Mask: 8000h	Bit	LS-5x1 v2, LS-5x2 v2
			System B phase rotation CW (ToolKit)	Mask: 4000h	Bit	LS-5x1 v2, LS-5x2 v2
			System A phase rotation CCW (ToolKit)	Mask: 2000h	Bit	LS-5x1 v2, LS-5x2 v2
			System A phase rotation CW (ToolKit)	Mask: 1000h	Bit	LS-5x1 v2, LS-5x2 v2
			internal	Mask: 0800h	Bit	
			internal	Mask: 0400h	Bit	
			internal	Mask: 0200h	Bit	
			internal	Mask: 0100h	Bit	
			internal	Mask: 0080h	Bit	
			internal	Mask: 0040h	Bit	
			internal	Mask: 0020h	Bit	
			internal	Mask: 0010h	Bit	
			Syst. A phase rotation CW (for ToolKit)	Mask: 0008h	Bit	LS-5x1 v2, LS-5x2 v2
			Syst. A phase rotation CCW (for ToolKit)	Mask: 0004h	Bit	LS-5x1 v2, LS-5x2 v2
			Syst. B phase rotation CW (for ToolKit)	Mask: 0002h	Bit	LS-5x1 v2, LS-5x2 v2

CAN		Parameter ID	Description	Multiplier	Units	Model
Data byte 0 (Mux)	Data byte					
			Syst. B phase rotation CCW (for ToolKit)	Mask: 0001h	Bit	LS-5x1 v2, LS-5x2 v2
28	1,2	10133	internal	Mask: 8000h	Bit	
			internal	Mask: 4000h	Bit	
			internal	Mask: 2000h	Bit	
			internal	Mask: 1000h	Bit	
			internal	Mask: 0800h	Bit	
			internal	Mask: 0400h	Bit	
			internal	Mask: 0200h	Bit	
			08.05 CB B close not successful	Mask: 0100h	Bit	LS-5x2 v2
			08.06 CB B open not successful	Mask: 0080h	Bit	LS-5x2 v2
			08.07 CB A close not successful	Mask: 0040h	Bit	LS-5x1 v2, LS-5x2 v2
			08.08 CB A open not successful	Mask: 0020h	Bit	LS-5x1 v2, LS-5x2 v2
			internal	Mask: 0010h	Bit	
			internal	Mask: 0008h	Bit	
			internal	Mask: 0004h	Bit	
			internal	Mask: 0002h	Bit	
08.18 CANopen error interface 1	Mask: 0001h	Bit	LS-5x1 v2, LS-5x2 v2			
28	3,4	10191	internal	Mask: 8000h	Bit	
			internal	Mask: 4000h	Bit	
			internal	Mask: 2000h	Bit	
			24.45 Flag 5 LS 5	Mask: 1000h	Bit	LS-5x1 v2, LS-5x2 v2
			24.44 Flag 4 LS 5	Mask: 0800h	Bit	LS-5x1 v2, LS-5x2 v2
			24.43 Flag 3 LS 5	Mask: 0400h	Bit	LS-5x1 v2, LS-5x2 v2
			24.42 Flag 2 LS 5	Mask: 0200h	Bit	LS-5x1 v2, LS-5x2 v2
			24.41 Flag 1 LS 5	Mask: 0100h	Bit	LS-5x1 v2, LS-5x2 v2
			24.38 LM variable system is A	Mask: 0080h	Bit	LS-5x2 v2
			24.37 Enable to close CB B	Mask: 0040h	Bit	LS-5x2 v2
			24.36 Immediate open CB B	Mask: 0020h	Bit	LS-5x2 v2
			24.35 Open CB B	Mask: 0010h	Bit	LS-5x2 v2
			24.34 Enable to close CB A	Mask: 0008h	Bit	LS-5x1 v2, LS-5x2 v2
			24.33 Immediate open CB A	Mask: 0004h	Bit	LS-5x1 v2, LS-5x2 v2
			24.32 Open CB A	Mask: 0002h	Bit	LS-5x1 v2, LS-5x2 v2

CAN		Param-eter ID	Description	Multiplier	Units	Model
Data byte 0 (Mux)	Data byte					
			24.31 Enable mains decoupling	Mask: 0001h	Bit	LS-5x1 v2, LS-5x2 v2
28	5,6	10138	internal	Mask: 8000h	Bit	
			internal	Mask: 4000h	Bit	
			internal	Mask: 2000h	Bit	
			internal	Mask: 1000h	Bit	
			internal	Mask: 0800h	Bit	
			06.21 System B phase rotation	Mask: 0400h	Bit	LS-5x1 v2, LS-5x2 v2
			internal	Mask: 0200h	Bit	
			08.46 CB B unload mismatch	Mask: 0100h	Bit	LS-5x2 v2
			internal	Mask: 0080h	Bit	
			internal	Mask: 0040h	Bit	
			internal	Mask: 0020h	Bit	
			internal	Mask: 0010h	Bit	
			internal	Mask: 0008h	Bit	
			internal	Mask: 0004h	Bit	
internal	Mask: 0002h	Bit				
internal	Mask: 0001h	Bit				
29	1,2	10135	07.06 System A overfrequency threshold 1	Mask: 8000h	Bit	LS-5x1 v2, LS-5x2 v2
			07.07 System A overfrequency threshold 2	Mask: 4000h	Bit	LS-5x1 v2, LS-5x2 v2
			07.08 System A underfrequency threshold 1	Mask: 2000h	Bit	LS-5x1 v2, LS-5x2 v2
			07.09 System A underfrequency threshold 2	Mask: 1000h	Bit	LS-5x1 v2, LS-5x2 v2
			07.10 System A overvoltage threshold 1	Mask: 0800h	Bit	LS-5x1 v2, LS-5x2 v2
			07.11 System A overvoltage threshold 2	Mask: 0400h	Bit	LS-5x1 v2, LS-5x2 v2
			07.12 System A undervoltage threshold 1	Mask: 0200h	Bit	LS-5x1 v2, LS-5x2 v2
			07.13 System A undervoltage threshold 2	Mask: 0100h	Bit	LS-5x1 v2, LS-5x2 v2
			07.14 System A phase shift	Mask: 0080h	Bit	LS-5x1 v2, LS-5x2 v2
			07.25 System A decoupling	Mask: 0040h	Bit	LS-5x1 v2, LS-5x2 v2
			internal	Mask: 0020h	Bit	
			internal	Mask: 0010h	Bit	
			07.26 System A voltage asymmetry (with negative sequence)	Mask: 0008h	Bit	LS-5x1 v2, LS-5x2 v2

CAN		Parameter ID	Description	Multiplier	Units	Model
Data byte 0 (Mux)	Data byte					
			07.05 System A phase rotation	Mask: 0004h	Bit	LS-5x1 v2, LS-5x2 v2
			internal	Mask: 0002h	Bit	
			internal	Mask: 0001h	Bit	
29	3,4	4138	internal	Mask: 8000h	Bit	
			internal	Mask: 4000h	Bit	
			internal	Mask: 2000h	Bit	
			internal	Mask: 1000h	Bit	
			internal	Mask: 0800h	Bit	
			internal	Mask: 0400h	Bit	
			internal	Mask: 0200h	Bit	
			internal	Mask: 0100h	Bit	
			07.15 df/dt (ROCOF)	Mask: 0080h	Bit	LS-5x1 v2, LS-5x2 v2
			internal	Mask: 0040h	Bit	
			07.28 System A time-dependent voltage	Mask: 0020h	Bit	LS-5x1 v2, LS-5x2 v2
			internal	Mask: 0010h	Bit	
			07.27 System A voltage increase	Mask: 0008h	Bit	LS-5x1 v2, LS-5x2 v2
			08.36 CB A unload mismatch	Mask: 0004h	Bit	LS-5x1 v2, LS-5x2 v2
			07.29 QV Monitoring step 1 tripped	Mask: 0002h	Bit	LS-5x1 v2, LS-5x2 v2
			07.30 QV Monitoring step 2 tripped	Mask: 0001h	Bit	LS-5x1 v2, LS-5x2 v2
29	5,6	-	internal	Mask: 8000h	Bit	
			internal	Mask: 4000h	Bit	
			internal	Mask: 2000h	Bit	
			internal	Mask: 1000h	Bit	
			internal	Mask: 0800h	Bit	
			internal	Mask: 0400h	Bit	
			internal	Mask: 0200h	Bit	
			internal	Mask: 0100h	Bit	
			internal	Mask: 0080h	Bit	
			internal	Mask: 0040h	Bit	
			internal	Mask: 0020h	Bit	
			internal	Mask: 0010h	Bit	
			internal	Mask: 0008h	Bit	
			internal	Mask: 0004h	Bit	

CAN		Parameter ID	Description	Multiplier	Units	Model
Data byte 0 (Mux)	Data byte					
			internal	Mask: 0002h	Bit	
			internal	Mask: 0001h	Bit	

9.2.1.2 Data Protocol 5302 (Basic Visualization)

CAN		Parameter ID	Description	Multiplier	Units	Model
Data byte 0 (Mux)	Data byte					
0	1,2		Protocol ID, always 5302			LS-5x1 v2, LS-5x2 v2
0	3,4,5,6	136	System A total reactive power	1	Var	LS-5x1 v2, LS-5x2 v2
1	1,2	160	System A power factor (cos.phi)	0.001		LS-5x1 v2, LS-5x2 v2
1	3,4,5,6	170	System A average wye voltage	0.1	V	LS-5x1 v2, LS-5x2 v2
2	1,2	144	System A frequency	0.01	Hz	LS-5x1 v2, LS-5x2 v2
2	3,4,5,6	171	System A average delta voltage	0.1	V	LS-5x1 v2, LS-5x2 v2
3	1,2	10202	Operation modes 13280 = CB A request 13264 = Unloading CB A 13210 = CB A Dead bus closure 13260 = Synchronization CB A 13205 = Mains settling time running 13257 = Open CB A 13279 = Synchronization network close CB A 13265 = Synchronization PERMISSIVE 13266 = Synchronization CHECK 13267 = Synchronization OFF 13286 = Synchronization segments close CB A The following operation modes are supported by the LS-5x2 v2 only: 13256 = Unloading CB B 13261 = CB B - CB A delay 13262 = CB A - CB B delay 13259 = Synchronization CB B 13255 = Open CB B 13340 = CB B request 13209 = CB B Dead bus closure			LS-5x1 v2, LS-5x2 v2
3	3,4,5,6	337	System A total active power AC measurement	1	W	LS-5x1 v2, LS-5x2 v2
4	1,2	10107	Discrete outputs 1 to 6			

CAN		Parameter ID	Description	Multiplier	Units	Model
Data byte 0 (Mux)	Data byte					
			Relay-Output 1 (inverted)	Mask: 8000h	Bit	LS-5x1 v2, LS-5x2 v2
			Relay-Output 2	Mask: 4000h	Bit	LS-5x1 v2, LS-5x2 v2
			Relay-Output 3	Mask: 2000h	Bit	LS-5x1 v2, LS-5x2 v2
			Relay-Output 4	Mask: 1000h	Bit	LS-5x1 v2, LS-5x2 v2
			Relay-Output 5	Mask: 0800h	Bit	LS-5x1 v2, LS-5x2 v2
			Relay-Output 6	Mask: 0400h	Bit	LS-5x1 v2, LS-5x2 v2
			internal	Mask: 0200h	Bit	
			internal	Mask: 0100h	Bit	
			internal	Mask: 0080h	Bit	
			internal	Mask: 0040h	Bit	
			internal	Mask: 0020h	Bit	
			internal	Mask: 0010h	Bit	
			internal	Mask: 0008h	Bit	
			internal	Mask: 0004h	Bit	
			internal	Mask: 0002h	Bit	
			internal	Mask: 0001h	Bit	
4	3,4,5,6	185	System A current average	0.001	A	LS-5x1 v2, LS-5x2 v2
5	1,2	8018	internal	Mask: 0001h	Bit	
			internal	Mask: 0002h	Bit	
			internal	Mask: 0004h	Bit	
			internal	Mask: 0008h	Bit	
			internal	Mask: 0010h	Bit	
			internal	Mask: 0020h	Bit	
			internal	Mask: 0040h	Bit	
			internal	Mask: 0080h	Bit	
			28.01 Command to CB-control 1 (OR'ed)	Mask: 0100h	Bit	LS-5x1 v2, LS-5x2 v2
			28.02 Command to CB-control 2 (OR'ed)	Mask: 0200h	Bit	LS-5x1 v2, LS-5x2 v2
			28.03 Command to CB-control 3 (OR'ed)	Mask: 0400h	Bit	LS-5x1 v2, LS-5x2 v2
			28.04 Command to CB-control 4 (OR'ed)	Mask: 0800h	Bit	LS-5x1 v2, LS-5x2 v2
			28.05 Command to CB-control 5 (OR'ed)	Mask: 1000h	Bit	LS-5x1 v2, LS-5x2 v2

Appendix

Data Protocols > CANopen > Data Protocol 5302 (Basic ...

CAN		Parameter ID	Description	Multiplier	Units	Model
Data byte 0 (Mux)	Data byte					
			28.06 Command to CB-control 6 (OR'ed)	Mask: 2000h	Bit	LS-5x1 v2, LS-5x2 v2
			internal	Mask: 4000h	Bit	
			internal	Mask: 8000h	Bit	
5	3,4,5,6	111	System A current 1	0.001	A	LS-5x1 v2, LS-5x2 v2
6	1,2	10110	Battery voltage	0.1	V	LS-5x1 v2, LS-5x2 v2
6	3,4,5,6	112	System A current 2	0.001	A	LS-5x1 v2, LS-5x2 v2
7	1,2	10146	internal	Mask: 0001h	Bit	
			internal	Mask: 0002h	Bit	
			internal	Mask: 0004h	Bit	
			11.07 Active second	Mask: 0008h	Bit	LS-5x1 v2, LS-5x2 v2
			11.06 Active minute	Mask: 0010h	Bit	LS-5x1 v2, LS-5x2 v2
			11.05 Active hour	Mask: 0020h	Bit	LS-5x1 v2, LS-5x2 v2
			11.04 Active day in month	Mask: 0040h	Bit	LS-5x1 v2, LS-5x2 v2
			11.03 Active weekday	Mask: 0080h	Bit	LS-5x1 v2, LS-5x2 v2
			11.02 Time 2 overrun	Mask: 0100h	Bit	LS-5x1 v2, LS-5x2 v2
			11.01 Time 1 overrun	Mask: 0200h	Bit	LS-5x1 v2, LS-5x2 v2
			internal	Mask: 0400h	Bit	
			04.05 Acknowledge was executed	Mask: 0800h	Bit	LS-5x1 v2, LS-5x2 v2
			01.09 Shutdown alarm active (alarm C-F)	Mask: 1000h	Bit	LS-5x1 v2, LS-5x2 v2
			internal	Mask: 2000h	Bit	
			internal	Mask: 4000h	Bit	
			internal	Mask: 8000h	Bit	
7	3,4,5,6	113	System A current 3	0.001	A	LS-5x1 v2, LS-5x2 v2
8	1,2	10107	00.41 LM Relay 1	Mask: 8000h	Bit	LS-5x1 v2, LS-5x2 v2
			00.42 LM Relay 2	Mask: 4000h	Bit	LS-5x1 v2, LS-5x2 v2
			00.43 LM Relay 3	Mask: 2000h	Bit	LS-5x1 v2, LS-5x2 v2
			00.44 LM Relay 4	Mask: 1000h	Bit	LS-5x1 v2, LS-5x2 v2
			00.45 LM Relay 5	Mask: 0800h	Bit	LS-5x1 v2, LS-5x2 v2

CAN		Parameter ID	Description	Multiplier	Units	Model
Data byte 0 (Mux)	Data byte					
			00.46 LM Relay 6	Mask: 0400h	Bit	LS-5x1 v2, LS-5x2 v2
			internal	Mask: 0200h	Bit	
			internal	Mask: 0100h	Bit	
			internal	Mask: 0080h	Bit	
			internal	Mask: 0040h	Bit	
			internal	Mask: 0020h	Bit	
			internal	Mask: 0010h	Bit	
			internal	Mask: 0008h	Bit	
			internal	Mask: 0004h	Bit	
			internal	Mask: 0002h	Bit	
			internal	Mask: 0001h	Bit	
8	3,4,5,6	108	System A voltage L1-L2	0.1	V	LS-5x1 v2, LS-5x2 v2
9	1,2	10140	00.01 LM Internal flag 1	Mask: 8000h	Bit	LS-5x1 v2, LS-5x2 v2
			00.02 LM Internal flag 2	Mask: 4000h	Bit	LS-5x1 v2, LS-5x2 v2
			00.03 LM Internal flag 3	Mask: 2000h	Bit	LS-5x1 v2, LS-5x2 v2
			00.04 LM Internal flag 4	Mask: 1000h	Bit	LS-5x1 v2, LS-5x2 v2
			00.05 LM Internal flag 5	Mask: 0800h	Bit	LS-5x1 v2, LS-5x2 v2
			00.06 LM Internal flag 6	Mask: 0400h	Bit	LS-5x1 v2, LS-5x2 v2
			00.07 LM Internal flag 7	Mask: 0200h	Bit	LS-5x1 v2, LS-5x2 v2
			00.08 LM Internal flag 8	Mask: 0100h	Bit	LS-5x1 v2, LS-5x2 v2
			internal	Mask: 0080h	Bit	
			internal	Mask: 0040h	Bit	
			internal	Mask: 0020h	Bit	
			00.15 LM External acknowledge	Mask: 0010h	Bit	LS-5x1 v2, LS-5x2 v2
			internal	Mask: 0008h	Bit	
			00.16 LM Operation mode AUTOMATIC	Mask: 0004h	Bit	LS-5x1 v2, LS-5x2 v2
			00.17 LM Operation mode MANUAL	Mask: 0002h	Bit	LS-5x1 v2, LS-5x2 v2
			internal	Mask: 0001h	Bit	
9	3,4,5,6	114	System A voltage L1-N	0.1	V	LS-5x1 v2, LS-5x2 v2
10	1,2	10148	internal	Mask: 8000h	Bit	

Appendix

Data Protocols > CANopen > Data Protocol 5302 (Basic ...

CAN		Param- eter ID	Description	Multiplier	Units	Model
Data byte 0 (Mux)	Data byte					
			internal	Mask: 4000h	Bit	
			internal	Mask: 2000h	Bit	
			internal	Mask: 1000h	Bit	
			04.04 Lamp test	Mask: 0800h	Bit	LS-5x1 v2, LS-5x2 v2
			01.10 Centralized alarms active (alarm B-F)	Mask: 0400h	Bit	LS-5x1 v2, LS-5x2 v2
			01.07 All alarm classes are active	Mask: 0200h	Bit	LS-5x1 v2, LS-5x2 v2
			01.08 Warning alarms active (alarm A, B)	Mask: 0100h	Bit	LS-5x1 v2, LS-5x2 v2
			internal	Mask: 0080h	Bit	
			internal	Mask: 0040h	Bit	
			internal	Mask: 0020h	Bit	
			internal	Mask: 0010h	Bit	
			internal	Mask: 0008h	Bit	
			internal	Mask: 0004h	Bit	
			internal	Mask: 0002h	Bit	
			internal	Mask: 0001h	Bit	
10	3,4,5,6	109	System A voltage L2-L3	0.1	V	LS-5x1 v2, LS-5x2 v2
11	1,2	10150	internal	Mask: 8000h	Bit	
			internal	Mask: 4000h	Bit	
			internal	Mask: 2000h	Bit	
			internal	Mask: 1000h	Bit	
			internal	Mask: 0800h	Bit	
			internal	Mask: 0400h	Bit	
			00.30 LM Internal flag 9	Mask: 0200h	Bit	LS-5x1 v2, LS-5x2 v2
			00.31 LM Internal flag 10	Mask: 0100h	Bit	LS-5x1 v2, LS-5x2 v2
			00.32 LM Internal flag 11	Mask: 0080h	Bit	LS-5x1 v2, LS-5x2 v2
			00.33 LM Internal flag 12	Mask: 0040h	Bit	LS-5x1 v2, LS-5x2 v2
			00.34 LM Internal flag 13	Mask: 0020h	Bit	LS-5x1 v2, LS-5x2 v2
			00.35 LM Internal flag 14	Mask: 0010h	Bit	LS-5x1 v2, LS-5x2 v2
			00.36 LM Internal flag 15	Mask: 0008h	Bit	LS-5x1 v2, LS-5x2 v2
00.37 LM Internal flag 16	Mask: 0004h	Bit	LS-5x1 v2, LS-5x2 v2			

CAN		Parameter ID	Description	Multiplier	Units	Model			
Data byte 0 (Mux)	Data byte								
			internal	Mask: 0002h	Bit				
			internal	Mask: 0001h	Bit				
11	3,4,5,6	115	System A voltage L2-N	0.1	V	LS-5x1 v2, LS-5x2 v2			
12	1,2	10160	internal	Mask: 8000h	Bit				
			internal	Mask: 4000h	Bit				
			internal	Mask: 2000h	Bit				
			internal	Mask: 1000h	Bit				
			internal	Mask: 0800h	Bit				
			internal	Mask: 0400h	Bit				
			internal	Mask: 0200h	Bit				
			internal	Mask: 0100h	Bit				
			internal	Mask: 0080h	Bit				
			internal	Mask: 0040h	Bit				
			internal	Mask: 0020h	Bit				
			internal	Mask: 0010h	Bit				
			internal	Mask: 0008h	Bit				
			internal	Mask: 0004h	Bit				
						01.11 New alarm triggered	Mask: 0002h	Bit	LS-5x1 v2, LS-5x2 v2
			internal	Mask: 0001h	Bit				
12	3,4,5,6	110	System A voltage L3-L1	0.1	V	LS-5x1 v2, LS-5x2 v2			
13	1,2	10162	internal	Mask: 8000h	Bit				
			internal	Mask: 4000h	Bit				
			internal	Mask: 2000h	Bit				
			internal	Mask: 1000h	Bit				
			internal	Mask: 0800h	Bit				
			internal	Mask: 0400h	Bit				
			internal	Mask: 0200h	Bit				
			internal	Mask: 0100h	Bit				
			internal	Mask: 0080h	Bit				
			internal	Mask: 0040h	Bit				
			internal	Mask: 0020h	Bit				
			internal	Mask: 0010h	Bit				
			internal	Mask: 0008h	Bit				
						00.38 LM Synchronization mode CHECK	Mask: 0004h	Bit	LS-5x1 v2, LS-5x2 v2

Appendix

Data Protocols > CANopen > Data Protocol 5302 (Basic ...

CAN		Parameter ID	Description	Multiplier	Units	Model
Data byte 0 (Mux)	Data byte					
			00.39 LM Synchronization mode PERMISSIVE	Mask: 0002h	Bit	LS-5x1 v2, LS-5x2 v2
			00.40 LM Synchronization mode RUN	Mask: 0001h	Bit	LS-5x1 v2, LS-5x2 v2
13	3,4,5,6	116	System A voltage L3-N	0.1	V	LS-5x1 v2, LS-5x2 v2
14	1,2	10131	internal	Mask: 8000h	Bit	
			internal	Mask: 4000h	Bit	
			internal	Mask: 2000h	Bit	
			internal	Mask: 1000h	Bit	
			internal	Mask: 0800h	Bit	
			internal	Mask: 0400h	Bit	
			internal	Mask: 0200h	Bit	
			internal	Mask: 0100h	Bit	
			internal	Mask: 0080h	Bit	
			internal	Mask: 0040h	Bit	
			Alarm class F latched	Mask: 0020h	Bit	LS-5x1 v2, LS-5x2 v2
			Alarm class E latched	Mask: 0010h	Bit	LS-5x1 v2, LS-5x2 v2
			Alarm class D latched	Mask: 0008h	Bit	LS-5x1 v2, LS-5x2 v2
			Alarm class C latched	Mask: 0004h	Bit	LS-5x1 v2, LS-5x2 v2
Alarm class B latched	Mask: 0002h	Bit	LS-5x1 v2, LS-5x2 v2			
Alarm class A latched	Mask: 0001h	Bit	LS-5x1 v2, LS-5x2 v2			
14	3,4,5,6	2520	System A positive active energy	0.01	MWh	LS-5x1 v2, LS-5x2 v2
15	1,2	10132	State Discrete Input 8 latched	Mask: 8000h	Bit	LS-5x1 v2, LS-5x2 v2
			State Discrete Input 7 latched	Mask: 4000h	Bit	LS-5x1 v2, LS-5x2 v2
			State Discrete Input 6 latched	Mask: 2000h	Bit	LS-5x1 v2, LS-5x2 v2
			State Discrete Input 5 latched	Mask: 1000h	Bit	LS-5x1 v2, LS-5x2 v2
			State Discrete Input 4 latched	Mask: 0800h	Bit	LS-5x1 v2, LS-5x2 v2
			State Discrete Input 3 latched	Mask: 0400h	Bit	LS-5x1 v2, LS-5x2 v2
			State Discrete Input 2 latched	Mask: 0200h	Bit	LS-5x1 v2, LS-5x2 v2
			State Discrete Input 1 latched	Mask: 0100h	Bit	LS-5x1 v2, LS-5x2 v2
			internal	Mask: 0080h	Bit	

CAN		Parameter ID	Description	Multiplier	Units	Model
Data byte 0 (Mux)	Data byte					
			internal	Mask: 0040h	Bit	
			internal	Mask: 0020h	Bit	
			internal	Mask: 0010h	Bit	
			internal	Mask: 0008h	Bit	
			internal	Mask: 0004h	Bit	
			internal	Mask: 0002h	Bit	
			internal	Mask: 0001h	Bit	
15	3,4,5,6	173	System B average wye voltage	0.1	V	LS-5x1 v2, LS-5x2 v2
16	1,2	147	System B frequency	0.01	Hz	LS-5x1 v2, LS-5x2 v2
16	3,4,5,6	174	System B average delta voltage	0.1	V	LS-5x1 v2, LS-5x2 v2
17	1,2	10111	Analog input 1	-	-	LS-5x2 v2
17	3,4,5,6	207	System B average current	0.001	A	LS-5x2 v2
18	1,2	208	System B power factor	0.001	-	LS-5x2 v2
18	3,4,5,6	338	System B total active power AC measurement	1	W	LS-5x2 v2
19	1,2	10137	internal	Mask: 8000h	Bit	
			internal	Mask: 4000h	Bit	
			internal	Mask: 2000h	Bit	
			internal	Mask: 1000h	Bit	
			internal	Mask: 0800h	Bit	
			internal	Mask: 0400h	Bit	
			internal	Mask: 0200h	Bit	
			internal	Mask: 0100h	Bit	
			internal	Mask: 0080h	Bit	
			internal	Mask: 0040h	Bit	
			internal	Mask: 0020h	Bit	
			internal	Mask: 0010h	Bit	
			internal	Mask: 0008h	Bit	
			internal	Mask: 0004h	Bit	
			10.01 Analog input 1, wire break	Mask: 0002h	Bit	LS-5x2 v2
internal	Mask: 0001h	Bit				
19	3,4,5,6	150	System B total reactive power	1	var	LS-5x2 v2
20	1,2	534	04.59 Remote control bit 16	Mask: 8000h	Bit	LS-5x1 v2, LS-5x2 v2
			04.58 Remote control bit 15	Mask: 4000h	Bit	LS-5x1 v2, LS-5x2 v2
			04.57 Remote control bit 14	Mask: 2000h	Bit	LS-5x1 v2, LS-5x2 v2

Appendix

Data Protocols > CANopen > Data Protocol 5302 (Basic ...

CAN		Parameter ID	Description	Multiplier	Units	Model
Data byte 0 (Mux)	Data byte					
			04.56 Remote control bit 13	Mask: 1000h	Bit	LS-5x1 v2, LS-5x2 v2
			04.55 Remote control bit 12	Mask: 0800h	Bit	LS-5x1 v2, LS-5x2 v2
			04.54 Remote control bit 11	Mask: 0400h	Bit	LS-5x1 v2, LS-5x2 v2
			04.53 Remote control bit 10	Mask: 0200h	Bit	LS-5x1 v2, LS-5x2 v2
			04.52 Remote control bit 9	Mask: 0100h	Bit	LS-5x1 v2, LS-5x2 v2
			04.51 Remote control bit 8	Mask: 0080h	Bit	LS-5x1 v2, LS-5x2 v2
			04.50 Remote control bit 7	Mask: 0040h	Bit	LS-5x1 v2, LS-5x2 v2
			04.49 Remote control bit 6	Mask: 0020h	Bit	LS-5x1 v2, LS-5x2 v2
			04.48 Remote control bit 5	Mask: 0010h	Bit	LS-5x1 v2, LS-5x2 v2
			04.47 Remote control bit 4	Mask: 0008h	Bit	LS-5x1 v2, LS-5x2 v2
			04.46 Remote control bit 3	Mask: 0004h	Bit	LS-5x1 v2, LS-5x2 v2
			04.45 Remote control bit 2	Mask: 0002h	Bit	LS-5x1 v2, LS-5x2 v2
			04.44 Remote control bit 1	Mask: 0001h	Bit	LS-5x1 v2, LS-5x2 v2
20	3,4,5,6	134	System B current 1	0.001	A	LS-5x2 v2
21	1,2	10136	internal	Mask: 8000h	Bit	
			internal	Mask: 4000h	Bit	
			internal	Mask: 2000h	Bit	
			internal	Mask: 1000h	Bit	
			internal	Mask: 0800h	Bit	
			internal	Mask: 0400h	Bit	
			internal	Mask: 0200h	Bit	
			internal	Mask: 0100h	Bit	
			internal	Mask: 0080h	Bit	
			internal	Mask: 0040h	Bit	
			internal	Mask: 0020h	Bit	
			internal	Mask: 0010h	Bit	
			08.02 Battery overvoltage threshold 2	Mask: 0008h	Bit	LS-5x1 v2, LS-5x2 v2
			08.04 Battery undervoltage threshold 2	Mask: 0004h	Bit	LS-5x1 v2, LS-5x2 v2
			08.01 Battery overvoltage threshold 1	Mask: 0002h	Bit	LS-5x1 v2, LS-5x2 v2

CAN		Parameter ID	Description	Multiplier	Units	Model
Data byte 0 (Mux)	Data byte					
			08.03 Battery undervoltage threshold 1	Mask: 0001h	Bit	LS-5x1 v2, LS-5x2 v2
21	3,4,5,6	118	System B voltage L1-L2	0.1	V	LS-5x1 v2, LS-5x2 v2
22	1,2	4139	02.03 System B voltage in range (Based on system B operating voltage window)	Mask: 8000h	Bit	LS-5x1 v2, LS-5x2 v2
			02.04 System B frequency in range (Based on system B operating frequency window)	Mask: 4000h	Bit	LS-5x1 v2, LS-5x2 v2
			02.05 System B voltage and frequency in range (Ready for operation, 02.03 AND 02.04 are TRUE)	Mask: 2000h	Bit	LS-5x1 v2, LS-5x2 v2
			02.09 System A voltage in range (Based on system A voltage window)	Mask: 1000h	Bit	LS-5x1 v2, LS-5x2 v2
			internal	Mask: 0800h	Bit	
			internal	Mask: 0400h	Bit	
			02.10 System A frequency in range (Based on system A frequency window)	Mask: 0200h	Bit	LS-5x1 v2, LS-5x2 v2
			internal	Mask: 0100h	Bit	
			internal	Mask: 0080h	Bit	
			02.11 System A voltage and frequency in range (Ready for operation, 02.09 AND 02.10 are TRUE)	Mask: 0040h	Bit	LS-5x1 v2, LS-5x2 v2
			internal	Mask: 0020h	Bit	
			internal	Mask: 0010h	Bit	
			internal	Mask: 0008h	Bit	
			internal	Mask: 0004h	Bit	
internal	Mask: 0002h	Bit				
internal	Mask: 0001h	Bit				
22	3,4,5,6	121	System B voltage L1-N	0.1	V	LS-5x1 v2, LS-5x2 v2
23	1,2	1791	internal	Mask: 8000h	Bit	
			internal	Mask: 4000h	Bit	
			internal	Mask: 2000h	Bit	
			internal	Mask: 1000h	Bit	
			internal	Mask: 0800h	Bit	
			internal	Mask: 0400h	Bit	
			internal	Mask: 0200h	Bit	
			internal	Mask: 0100h	Bit	
			02.12 System A phase rotation Counter Clock Wise (CCW, reverse, left turn)	Mask: 0080h	Bit	LS-5x1 v2, LS-5x2 v2
			02.13 System A phase rotation Clock Wise (CW, forward, right turn)	Mask: 0040h	Bit	LS-5x1 v2, LS-5x2 v2

Appendix

Data Protocols > CANopen > Data Protocol 5302 (Basic ...

CAN		Parameter ID	Description	Multiplier	Units	Model
Data byte 0 (Mux)	Data byte					
			internal	Mask: 0020h	Bit	
			internal	Mask: 0010h	Bit	
			internal	Mask: 0008h	Bit	
			internal	Mask: 0004h	Bit	
			internal	Mask: 0002h	Bit	
			internal	Mask: 0001h	Bit	
23	3,4,5,6	119	System B voltage L2-L3	0.1	V	LS-5x1 v2, LS-5x2 v2
24	1,2	1792	internal	Mask: 8000h	Bit	
			internal	Mask: 4000h	Bit	
			internal	Mask: 2000h	Bit	
			internal	Mask: 1000h	Bit	
			internal	Mask: 0800h	Bit	
			internal	Mask: 0400h	Bit	
			internal	Mask: 0200h	Bit	
			internal	Mask: 0100h	Bit	
			02.14 System B phase rotation Counter Clock Wise (CCW, reverse, left turn)	Mask: 0080h	Bit	LS-5x1 v2, LS-5x2 v2
			02.15 System B phase rotation Clock Wise (CW, forward, right turn)	Mask: 0040h	Bit	LS-5x1 v2, LS-5x2 v2
			internal	Mask: 0020h	Bit	
			internal	Mask: 0010h	Bit	
			internal	Mask: 0008h	Bit	
			internal	Mask: 0004h	Bit	
internal	Mask: 0002h	Bit				
internal	Mask: 0001h	Bit				
24	3,4,5,6	122	System B voltage L2-N	0.1	V	LS-5x1 v2, LS-5x2 v2
25	1,2		internal	Mask: 8000h	Bit	
			04.63 Synchr. Segm Closure Pr. is act	Mask: 4000h	Bit	LS-5x1 v2, LS-5x2 v2
			internal	Mask: 2000h	Bit	
			02.28 Synch. Check Relay	Mask: 1000h	Bit	LS-5x1 v2, LS-5x2 v2
			02.29 Synch. Condition	Mask: 0800h	Bit	LS-5x1 v2, LS-5x2 v2
			02.30 Dead Bus Closure Condition	Mask: 0400h	Bit	LS-5x1 v2, LS-5x2 v2
			internal	Mask: 0200h	Bit	
			internal	Mask: 0100h	Bit	

CAN		Parameter ID	Description	Multiplier	Units	Model
Data byte 0 (Mux)	Data byte					
			internal	Mask: 0080h	Bit	
			internal	Mask: 0040h	Bit	
			internal	Mask: 0020h	Bit	
			internal	Mask: 0010h	Bit	
			internal	Mask: 0008h	Bit	
			internal	Mask: 0004h	Bit	
			internal	Mask: 0002h	Bit	
			internal	Mask: 0001h	Bit	
25	3,4,5,6	120	System B voltage L3-L1	0.1	V	LS-5x1 v2, LS-5x2 v2
26	1,2	10149	08.30 Timeout synchronization CB B	Mask: 8000h	Bit	LS-5x2 v2
			08.31 Timeout synchronization CB A	Mask: 4000h	Bit	LS-5x1 v2, LS-5x2 v2
			internal	Mask: 2000h	Bit	
			internal	Mask: 1000h	Bit	
			08.33 System A / System B phase rotation mismatch	Mask: 0800h	Bit	LS-5x1 v2, LS-5x2 v2
			reserved	Mask: 0400h	Bit	
			internal	Mask: 0200h	Bit	
			internal	Mask: 0100h	Bit	
			internal	Mask: 0080h	Bit	
			internal	Mask: 0040h	Bit	
			internal	Mask: 0020h	Bit	
			internal	Mask: 0010h	Bit	
			08.17 Number of member mismatch	Mask: 0008h	Bit	LS-5x1 v2, LS-5x2 v2
			05.15 EEPROM corrupted	Mask: 0004h	Bit	LS-5x1 v2, LS-5x2 v2
internal	Mask: 0002h	Bit				
internal	Mask: 0001h	Bit				
26	3,4,5,6	123	System B voltage L3-N	0.1	V	LS-5x1 v2, LS-5x2 v2
27	1,2	4153	04.42 Breaker transition mode alternative 2	Mask: 8000h	Bit	LS-5x2 v2
			04.41 Breaker transition mode alternative 1	Mask: 4000h	Bit	LS-5x2 v2
			04.29 Unloading CB A is active	Mask: 2000h	Bit	LS-5x1 v2, LS-5x2 v2
			04.28 Unloading CB B is active	Mask: 1000h	Bit	LS-5x2 v2
			04.23 Close command CB A is active	Mask: 0800h	Bit	LS-5x1 v2, LS-5x2 v2
			04.22 Open command CB A is active	Mask: 0400h	Bit	LS-5x1 v2, LS-5x2 v2

Appendix

Data Protocols > CANopen > Data Protocol 5302 (Basic ...

CAN		Param- eter ID	Description	Multiplier	Units	Model
Data byte 0 (Mux)	Data byte					
			04.21 Synchronization CB A procedure is active	Mask: 0200h	Bit	LS-5x1 v2, LS-5x2 v2
			04.20 Close command CB B is active	Mask: 0100h	Bit	LS-5x2 v2
			04.19 Open command CB B is active	Mask: 0080h	Bit	LS-5x2 v2
			04.18 Synchronisation CB B procedure is active	Mask: 0040h	Bit	LS-5x2 v2
			04.11 Mains settling is active	Mask: 0020h	Bit	LS-5x1 v2, LS-5x2 v2
			LS-5x1 v2: 24.39 Isolation switch is open LS-5x2 v2: 04.06 CB B is closed	Mask: 0010h	Bit	LS-5x1 v2, LS-5x2 v2
			04.07 CB A is closed	Mask: 0008h	Bit	LS-5x1 v2, LS-5x2 v2
			04.04 Lamp test request	Mask: 0004h	Bit	LS-5x1 v2, LS-5x2 v2
			04.03 Operating mode MANUAL	Mask: 0002h	Bit	LS-5x1 v2, LS-5x2 v2
			04.01 Operating mode AUTOMATIC	Mask: 0001h	Bit	LS-5x1 v2, LS-5x2 v2
			27	3,4	4154	02.23 System A is dead
02.24 System B is dead	Mask: 4000h	Bit				LS-5x1 v2, LS-5x2 v2
02.25 Mains parallel operation	Mask: 2000h	Bit				LS-5x1 v2, LS-5x2 v2
System B mains connected	Mask: 1000h	Bit				LS-5x1 v2, LS-5x2 v2
System A mains connected	Mask: 0800h	Bit				LS-5x1 v2, LS-5x2 v2
internal	Mask: 0400h	Bit				
internal	Mask: 0200h	Bit				
internal	Mask: 0100h	Bit				
internal	Mask: 0080h	Bit				
internal	Mask: 0040h	Bit				
internal	Mask: 0020h	Bit				
internal	Mask: 0010h	Bit				
internal	Mask: 0008h	Bit				
04.61 Synchronous mains closure procedure is active	Mask: 0004h	Bit				LS-5x1 v2, LS-5x2 v2
04.62 Dead bus closure procedure is active	Mask: 0002h	Bit				LS-5x1 v2, LS-5x2 v2
Increment close counter CB A	Mask: 0001h	Bit	LS-5x1 v2, LS-5x2 v2			
27	5,6	4155	System B phase rotation CCW (ToolKit)	Mask: 8000h	Bit	LS-5x1 v2, LS-5x2 v2

CAN		Parameter ID	Description	Multiplier	Units	Model
Data byte 0 (Mux)	Data byte					
			System B phase rotation CW (ToolKit)	Mask: 4000h	Bit	LS-5x1 v2, LS-5x2 v2
			System A phase rotation CCW (ToolKit)	Mask: 2000h	Bit	LS-5x1 v2, LS-5x2 v2
			System A phase rotation CW (ToolKit)	Mask: 1000h	Bit	LS-5x1 v2, LS-5x2 v2
			internal	Mask: 0800h	Bit	
			internal	Mask: 0400h	Bit	
			internal	Mask: 0200h	Bit	
			internal	Mask: 0100h	Bit	
			internal	Mask: 0080h	Bit	
			internal	Mask: 0040h	Bit	
			internal	Mask: 0020h	Bit	
			internal	Mask: 0010h	Bit	
			Syst. A phase rotation CW (for ToolKit)	Mask: 0008h	Bit	LS-5x1 v2, LS-5x2 v2
			Syst. A phase rotation CCW (for ToolKit)	Mask: 0004h	Bit	LS-5x1 v2, LS-5x2 v2
			Syst. B phase rotation CW (for ToolKit)	Mask: 0002h	Bit	LS-5x1 v2, LS-5x2 v2
			Syst. B phase rotation CCW (for ToolKit)	Mask: 0001h	Bit	LS-5x1 v2, LS-5x2 v2
28	1,2	10133	internal	Mask: 8000h	Bit	
			internal	Mask: 4000h	Bit	
			internal	Mask: 2000h	Bit	
			internal	Mask: 1000h	Bit	
			internal	Mask: 0800h	Bit	
			internal	Mask: 0400h	Bit	
			internal	Mask: 0200h	Bit	
			08.05 CB B close not successful	Mask: 0100h	Bit	LS-5x2 v2
			08.06 CB B open not successful	Mask: 0080h	Bit	LS-5x2 v2
			08.07 CB A close not successful	Mask: 0040h	Bit	LS-5x1 v2, LS-5x2 v2
			08.08 CB A open not successful	Mask: 0020h	Bit	LS-5x1 v2, LS-5x2 v2
			internal	Mask: 0010h	Bit	
			internal	Mask: 0008h	Bit	
			internal	Mask: 0004h	Bit	
			internal	Mask: 0002h	Bit	
			08.18 CANopen error interface 1	Mask: 0001h	Bit	LS-5x1 v2, LS-5x2 v2
28	3,4	10191	internal	Mask: 8000h	Bit	

Appendix

Data Protocols > CANopen > Data Protocol 5302 (Basic ...

CAN		Parameter ID	Description	Multiplier	Units	Model
Data byte 0 (Mux)	Data byte					
			internal	Mask: 4000h	Bit	
			internal	Mask: 2000h	Bit	
			24.45 Flag 5 LS 5	Mask: 1000h	Bit	LS-5x1 v2, LS-5x2 v2
			24.44 Flag 4 LS 5	Mask: 0800h	Bit	LS-5x1 v2, LS-5x2 v2
			24.43 Flag 3 LS 5	Mask: 0400h	Bit	LS-5x1 v2, LS-5x2 v2
			24.42 Flag 2 LS 5	Mask: 0200h	Bit	LS-5x1 v2, LS-5x2 v2
			24.41 Flag 1 LS 5	Mask: 0100h	Bit	LS-5x1 v2, LS-5x2 v2
			24.38 LM variable system is A	Mask: 0080h	Bit	LS-5x2 v2
			24.37 Enable to close CB B	Mask: 0040h	Bit	LS-5x2 v2
			24.36 Immediate open CB B	Mask: 0020h	Bit	LS-5x2 v2
			24.35 Open CB B	Mask: 0010h	Bit	LS-5x2 v2
			24.34 Enable to close CB A	Mask: 0008h	Bit	LS-5x1 v2, LS-5x2 v2
			24.33 Immediate open CB A	Mask: 0004h	Bit	LS-5x1 v2, LS-5x2 v2
			24.32 Open CB A	Mask: 0002h	Bit	LS-5x1 v2, LS-5x2 v2
			24.31 Enable mains decoupling	Mask: 0001h	Bit	LS-5x1 v2, LS-5x2 v2
28	5,6	10138	internal	Mask: 8000h	Bit	
			internal	Mask: 4000h	Bit	
			internal	Mask: 2000h	Bit	
			internal	Mask: 1000h	Bit	
			internal	Mask: 0800h	Bit	
			06.21 System B phase rotation	Mask: 0400h	Bit	LS-5x1 v2, LS-5x2 v2
			internal	Mask: 0200h	Bit	
			08.46 CB B unload mismatch	Mask: 0100h	Bit	LS-5x2 v2
			internal	Mask: 0080h	Bit	
			internal	Mask: 0040h	Bit	
			internal	Mask: 0020h	Bit	
			internal	Mask: 0010h	Bit	
			internal	Mask: 0008h	Bit	
			internal	Mask: 0004h	Bit	
			internal	Mask: 0002h	Bit	
internal	Mask: 0001h	Bit				
29	1,2	10135	07.06 System A overfrequency threshold 1	Mask: 8000h	Bit	LS-5x1 v2, LS-5x2 v2

CAN		Param- eter ID	Description	Multiplier	Units	Model
Data byte 0 (Mux)	Data byte					
			07.07 System A overfrequency threshold 2	Mask: 4000h	Bit	LS-5x1 v2, LS-5x2 v2
			07.08 System A underfrequency threshold 1	Mask: 2000h	Bit	LS-5x1 v2, LS-5x2 v2
			07.09 System A underfrequency threshold 2	Mask: 1000h	Bit	LS-5x1 v2, LS-5x2 v2
			07.10 System A overvoltage threshold 1	Mask: 0800h	Bit	LS-5x1 v2, LS-5x2 v2
			07.11 System A overvoltage threshold 2	Mask: 0400h	Bit	LS-5x1 v2, LS-5x2 v2
			07.12 System A undervoltage threshold 1	Mask: 0200h	Bit	LS-5x1 v2, LS-5x2 v2
			07.13 System A undervoltage threshold 2	Mask: 0100h	Bit	LS-5x1 v2, LS-5x2 v2
			07.14 System A phase shift	Mask: 0080h	Bit	LS-5x1 v2, LS-5x2 v2
			07.25 System A decoupling	Mask: 0040h	Bit	LS-5x1 v2, LS-5x2 v2
			internal	Mask: 0020h	Bit	
			internal	Mask: 0010h	Bit	
			07.26 System A voltage asymmetry (with negative sequence)	Mask: 0008h	Bit	LS-5x1 v2, LS-5x2 v2
			07.05 System A phase rotation	Mask: 0004h	Bit	LS-5x1 v2, LS-5x2 v2
			internal	Mask: 0002h	Bit	
			internal	Mask: 0001h	Bit	
29	3,4,5,6	135	System A total active power	1	W	LS-5x1 v2, LS-5x2 v2
30	1,2	4138	internal	Mask: 8000h	Bit	
			internal	Mask: 4000h	Bit	
			internal	Mask: 2000h	Bit	
			internal	Mask: 1000h	Bit	
			internal	Mask: 0800h	Bit	
			internal	Mask: 0400h	Bit	
			internal	Mask: 0200h	Bit	
			internal	Mask: 0100h	Bit	
			07.15 df/dt (ROCOF)	Mask: 0080h	Bit	LS-5x1 v2, LS-5x2 v2
			internal	Mask: 0040h	Bit	
			07.28 System A time-dependent voltage	Mask: 0020h	Bit	LS-5x1 v2, LS-5x2 v2
			internal	Mask: 0010h	Bit	
			07.27 System A voltage increase	Mask: 0008h	Bit	LS-5x1 v2, LS-5x2 v2

CAN		Parameter ID	Description	Multiplier	Units	Model
Data byte 0 (Mux)	Data byte					
			08.36 CB A unload mismatch	Mask: 0004h	Bit	LS-5x1 v2, LS-5x2 v2
			07.29 QV Monitoring step 1 tripped	Mask: 0002h	Bit	LS-5x1 v2, LS-5x2 v2
			07.30 QV Monitoring step 2 tripped	Mask: 0001h	Bit	LS-5x1 v2, LS-5x2 v2
30	3,4,5,6	140	System B total active power	1	W	LS-5x2 v2

9.2.1.3 Protocol 6003 (LS-5 Communication)

General information

The LS-5 communication message contains all data, which is required to operate the LS-5 system. This communication protocol works parallel to the load share communication.

In order to lower the bus load, the messages are divided into "fast", "normal", and "slow" refreshed data. The mux is identified accordingly with "F", "N", and "S" (refer to the following tables). The load share message contains one fast, two normal, and four slow messages, which are made up as in [“Load share bus communication” on page 308](#).

Timing

The time interval between two fast messages (T_{Fast} , i.e. the time for refreshing a fast message) is configured with the parameter "Transfer rate LS fast message" (parameter 9921 [p. 137](#)). The time intervals between refreshing a normal or slow messages depend on this parameter as well according to the following sequence:

- S0 – F – N0 – F – N1 – F – S1 – F – N0 – F – N1 – F – S2 – F – N0 – F – N1 – F – S3 – F – N0 – F – N1 – F
- T_{Fast} = time interval between refreshing the fast message
- T_{Normal} = time interval between refreshing a normal message = 3 x T_{Fast}
- T_{Slow} = time interval between refreshing a slow message = 12 x T_{Fast}

Example

- The parameter "Transfer rate LS fast message" (parameter 9921 ↗ p. 137) is configured to "0.10 s".
- The sequence of the sent messages for TFast = 100 ms (i.e. 0.10 s) is shown in ↗ "Load share bus communication" on page 308.
- This means that a new message is sent every 50 ms.

Time [ms]	0	50	100	150	200	250	300	350	400	450	500	550
Sent message	S0	F	N0	F	N1	F	S1	F	N0	F	N1	F
Mux #	0	3	1	3	2	3	4	3	1	3	2	3

Time [ms]	600	650	700	750	800	850	900	950	1000	1050	1100	1150
Sent message	S2	F	N0	F	N1	F	S3	F	N0	F	N1	F
Mux #	5	3	1	3	2	3	6	3	1	3	2	3

CAN bus load share line

The maximum length of the CAN bus load share line depends on this parameter as well. The values in ↗ *Table 44 "Load share line - max. length (32 participants)" on page 307* are valid for 32 participants and a bus load of approximately 40 %¹.

T _{Fast} [ms]	T _{Normal} [ms]	T _{Slow} [ms]	Baud rate [kBaud]	Distance [m]
100	300	1200	250	250
200	600	2400	125	500
300	900	3800	50	1000

Table 44: Load share line - max. length (32 participants)

The maximum length of the CAN bus load share line depends on this parameter as well. The values in ↗ *Table 45 "Load share line - max. length (48 participants)" on page 307* are valid for 48 participants and a bus load of approx. 40 %¹.

T _{Fast} [ms]	T _{Normal} [ms]	T _{Slow} [ms]	Baud rate [kBaud]	Distance [m]
100	300	1200	250	250
200	600	2400	125	500

Table 45: Load share line - max. length (48 participants)



¹ This approach incorporates two transmit PDO (remote control bits) by a PLC on CAN interface 3 with a refresh time same as the configured T_{Fast} - setting in the easYgen / LS-5.

Correlation of protocols

Parallel to the load share message protocol the easYgen also handles the LS-5 communication protocol.

	easYgen	LS-5
Load Share Message (protocol 6000)	Transmit / Receive	Receive
LS-5 Communication (protocol 6003)	Receive	Transmit / Receive

Load share bus communication

Load share bus communication - "fast" refreshed data					
Mux	Byte	Bit	Function	Remark	
F	0		3	Mux identifier	
	1		Frequency of connected mains or frequency to which is to synchronize	Frequency in 00.00 Hz	
	2				
	3		Phase angle between system A and B	Phase angle [1/10°]	
	4			Phase angle compensation is incorporated	
	5	0		System A in range	
		1		System B in range	
		2		System A is black	
		3		System B is black	
		4		Breaker 1 closed	
		5		Isolation switch closed	
		6		Synchronous networks detected	Between system A an B
		7		Not used	
	6			During the breaker unload situation: If bit 3 <i>"Execution of wish"</i> is set together with bit 0 <i>"Wish to open the breaker"</i> , the easYgen interprets this as an unload command.	
				During the breaker close situation (synchronization): If bit 3 <i>"Execution of wish"</i> is set together with bit 1 <i>"Wish to close the breaker"</i> , the easYgen interprets this as a synchronizing procedure.	
				If the 'Synchronization mode' is configured to 'Slip frequency' and a separate slip frequency offset is considered: bit 5 <i>"Synchronization Mode"</i> is "0", and bit 6 <i>"Synchronization with separate slip frequency offset"</i> is "1".	
				0	Wish to open the breaker
1				Wish to close the breaker	
2			Not used for 1breaker		
3		Execution of wish	The LS-5 informs that it will execute the wish for close or open its breaker. The execution wish isn't active during dead bus closure or immediately open from the breaker.		

Load share bus communication - "fast" refreshed data				
Mux	Byte	Bit	Function	Remark
				Notes In application mode LS5 (multiple LS5) only: <ul style="list-style-type: none"> ■ This bit will be send only if all of the additional conditions are TRUE: <ul style="list-style-type: none"> - Synchronization mode is RUN or CHECK - Different segment number between system A and B - Synchronous mains or segment closing isn't active
		4	Variable system 0 = System A 1 = System B	Notes The LS-5 informs that the "variable system" is on side A or B.
		5	Synchronization mode 0 = Slip frequency 1 = Phase matching	
		6	Synchronization with separate slip frequency offset	Notes In application mode LS5 (multiple LS5) only: <ul style="list-style-type: none"> ■ This bit will be send together with bit 3 "Execution of the wish"
		7	Not used	
	7		Not used	

Load share bus communication - "normal" refreshed data				
Mux	Byte	Bit	Function	Remark
N0	0		1	Mux identifier
	1		Voltage setpoint	Voltage of the fixed system in the percentage format (000.00 %) of the rated voltage setting
	2			
	3		Active power system A	Long [W]
	4			
	5			
	6			
	7		Not used	

Load share bus communication - "normal" refreshed data					
Mux	Byte	Bit	Function	Remark	
N1	0		2	Mux identifier	
	1		Not used		
	2		0	Logic bit 1	
			1	Logic bit 2	

Load share bus communication - "normal" refreshed data				
Mux	Byte	Bit	Function	Remark
		2	Logic bit 3	
		3	Logic bit 4	
		4	Logic bit 5	
		5	Mains settling active	
		6-7	Not used	
	3		Reactive power system A	Long [var]
	4			
	5			
	6			
		7		Not used

Load share bus communication - "slow" refreshed data				
Mux	Byte	Bit	Function	Remark
S0	0		0	Mux identifier
	1		Protocol-Identifier	6003
	2			
	3		Not used	
	4			
	5			
		6		Not used
	7			
S1	0		4	Mux identifier
	1	0-1	Mains wiring 0 = No mains wiring 1 = Mains wiring at system A 2 = Mains wiring at system B 3 = Mains wiring at isolation switch	
		4-6	Visualization message definition 0 = No valid information 1 = Average delta voltage of mains (visualization message 1) and average wye voltage of mains (visualization message 2)	Definition of byte 3..6 from Mux slow 2 and Mux slow 3: For changing the contents the device has to send "0" two times - one slow cycle before the contents changes and one slow cycle after the contents has changed. So there are two cycles the data is as marked not valid. There is one cycle with the old value and the next cycle with the new value. This is done because of the time differences between the different slow slots. The duration of one slow cycle is 1.2 s for i.e. fast cycle = 100 ms.
	7	Mains power measurement valid	This means the power of system A is used for mains import/export control	

Load share bus communication - "slow" refreshed data				
Mux	Byte	Bit	Function	Remark
	2	0-4		Not used for 1breaker
		5		Not used for 1breaker
		6-7	Not used	
	3			Not used for 1breaker
	4			
	5			
	6			
7		Not used		
S2	0		5	Mux identifier
	1	0-4	Segment number system A	1 to 32
		5	Extended bit for segment number system A	Max. 64 nodes possible
		6-7	Not used	
	2	0-4	Segment number system B	Max. 32 nodes possible
		5	Extended bit for segment number system B	Max. 64 nodes possible
		6-7	Not used	
	3		Visualization message 1	Dependent on visualization message defined in mux "S1"
	4			
	5			
6				
7		Not used		
S3	0		6	Mux identifier
	1		Not used	
	2		Not used	
	3		Visualization message 2	Dependent of visualization message defined in "Slow 1"
	4			
	5			
	6			
	7		Not used	

9.2.2 Modbus

9.2.2.1 Data Protocol 5300 (Basic Visualization)

Modbus		Parameter ID	Description	Multiplier	Units	Model
Modicon start addr.	Start addr. (*1)					
450001	450000		Protocol-ID, always 5300		–	LS-5x1 v2, LS-5x2 v2
450002	450001	3181	Scaling Power (16 bits) Exponent 10x W (5;4;3;2)			LS-5x1 v2, LS-5x2 v2
450003	450002	3182	Scaling Volts (16 bits) Exponent 10x V (2;1;0;-1)			LS-5x1 v2, LS-5x2 v2
450004	450003	3183	Scaling Amps (16 bits) Exponent 10x A (0;-1)			LS-5x1 v2, LS-5x2 v2
450005	450004		reserved			
450006	450005		reserved			
450007	450006		reserved			
450008	450007		reserved			
450009	450008		reserved			
AC System A Values						
450010	450009	144	System A frequency	0.01	Hz	LS-5x1 v2, LS-5x2 v2
450011	450010	246	Total system A active power AC measurement	scaled defined by index 3181 (modicon Address 450002)	W	LS-5x1 v2, LS-5x2 v2
450012	450011	247	Total system A reactive power	scaled defined by index 3181 (modicon Address 450002)	var	LS-5x1 v2, LS-5x2 v2
450013	450012	160	System A power factor	0.001		LS-5x1 v2, LS-5x2 v2
450014	450013	248	System A voltage L1-L2	scaled defined by index 3182 (modicon Address 450003)	V	LS-5x1 v2, LS-5x2 v2
450015	450014	249	System A voltage L2-L3	scaled defined by index 3182 (modicon Address 450003)	V	LS-5x1 v2, LS-5x2 v2
450016	450015	250	System A voltage L3-L1	scaled defined by index 3182 (modicon Address 450003)	V	LS-5x1 v2, LS-5x2 v2
450017	450016	251	System A voltage L1-N	scaled defined by index 3182 (modicon Address 450003)	V	LS-5x1 v2, LS-5x2 v2
450018	450017	252	System A voltage L2-N	scaled defined by index 3182 (modicon Address 450003)	V	LS-5x1 v2, LS-5x2 v2
450019	450018	253	System A voltage L3-N	scaled defined by index 3182 (modicon Address 450003)	V	LS-5x1 v2, LS-5x2 v2

Modbus		Parameter ID	Description	Multiplier	Units	Model
Mod- icon start addr.	Start addr. (*1)					
450020	450019	255	System A current 1	scaled defined by index 3183 (mod- icon Address 450004)	A	LS-5x1 v2, LS-5x2 v2
450021	450020	256	System A current 2	scaled defined by index 3183 (mod- icon Address 450004)	A	LS-5x1 v2, LS-5x2 v2
450022	450021	257	System A current 3	scaled defined by index 3183 (mod- icon Address 450004)	A	LS-5x1 v2, LS-5x2 v2
450023	450022	--	Total system A active power	scaled defined by index 3181 (mod- icon Address 450002)	W	LS-5x1 v2, LS-5x2 v2
450024	450023		reserved			
450025	450024		reserved			
450026	450025		reserved			
450027	450026		reserved			
450028	450027		reserved			
450029	450028		reserved			
AC System B Values						
450030	450029	147	System B frequency	0.01	Hz	LS-5x1 v2, LS-5x2 v2
450031	450030	258	Total system B active power AC measurement	scaled defined by index 3181 (mod- icon Address 450002)	W	LS-5x2 v2
450032	450031	259	Total system B reactive power	scaled defined by index 3181 (mod- icon Address 450002)	var	LS-5x2 v2
450033	450032	208	System B power factor	0.001		LS-5x2 v2
450034	450033	260	System B voltage L1-L2	scaled defined by index 3182 (mod- icon Address 450003)	V	LS-5x1 v2, LS-5x2 v2
450035	450034	261	System B voltage L2-L3	scaled defined by index 3182 (mod- icon Address 450003)	V	LS-5x1 v2, LS-5x2 v2
450036	450035	262	System B voltage L3-L1	scaled defined by index 3182 (mod- icon Address 450003)	V	LS-5x1 v2, LS-5x2 v2
450037	450036	263	System B voltage L1-N	scaled defined by index 3182 (mod- icon Address 450003)	V	LS-5x1 v2, LS-5x2 v2
450038	450037	264	System B voltage L2-N	scaled defined by index 3182 (mod- icon Address 450003)	V	LS-5x1 v2, LS-5x2 v2

Appendix

Data Protocols > Modbus > Data Protocol 5300 (Basic ...

Modbus		Parameter ID	Description	Multiplier	Units	Model
Mod- icon start addr.	Start addr. (*1)					
450039	450038	265	System B voltage L3-N	scaled defined by index 3182 (mod- icon Address 450003)	V	LS-5x1 v2, LS-5x2 v2
450040	450039	266	System B current L1	scaled defined by index 3183 (mod- icon Address 450004)	A	LS-5x2 v2
450041	450040	--	Total system B active power	scaled defined by index 3181 (mod- icon Address 450002)	W	LS-5x2 v2
450042	450041		reserved			
450043	450042		reserved			
450044	450043		reserved			
AC System Values						
450045	450044		reserved			
450046	450045		reserved			
450047	450046		reserved			
450048	450047		reserved			
450049	450048		reserved			
DC Analogue Values						
450050	450049	10110	Battery voltage	0.1	V	LS-5x1 v2, LS-5x2 v2
450051	450050	10111	Analog input 1	changeable		LS-5x2 v2
450052	450051		reserved			
450053	450052		reserved			
450054	450053		reserved			
450055	450054		reserved			
450056	450055		reserved			
450057	450056		reserved			
450058	450057		reserved			
450059	450058		reserved			
Control And Status						
450060	450059	10202	State display	Please refer to Chapter 9.4.2 "Status Messages" on page 385 for an ID description.	(enum.)	LS-5x1 v2, LS-5x2 v2
450061	450060	8018	Visualization remote and CB-Control			
			internal	Mask: 0001h	Bit	
			internal	Mask: 0002h	Bit	

Modbus		Parameter ID	Description	Multiplier	Units	Model
Mod- icon start addr.	Start addr. (*1)					
			internal	Mask: 0004h	Bit	
			internal	Mask: 0008h	Bit	
			internal	Mask: 0010h	Bit	
			internal	Mask: 0020h	Bit	
			internal	Mask: 0040h	Bit	
			internal	Mask: 0080h	Bit	
			28.01 Command to CB-control 1 (linked by logic 'OR')	Mask: 0100h	Bit	LS-5x1 v2, LS-5x2 v2
			28.02 Command to CB-control 2 (linked by logic 'OR')	Mask: 0200h	Bit	LS-5x1 v2, LS-5x2 v2
			28.03 Command to CB-control 3 (linked by logic 'OR')	Mask: 0400h	Bit	LS-5x1 v2, LS-5x2 v2
			28.04 Command to CB-control 4 (linked by logic 'OR')	Mask: 0800h	Bit	LS-5x1 v2, LS-5x2 v2
			28.05 Command to CB-control 5 (linked by logic 'OR')	Mask: 1000h	Bit	LS-5x1 v2, LS-5x2 v2
			28.06 Command to CB-control 6 (linked by logic 'OR')	Mask: 2000h	Bit	LS-5x1 v2, LS-5x2 v2
			internal	Mask: 4000h	Bit	
			internal	Mask: 8000h	Bit	
450062	450061	10146	LogicsManagerBits			
			internal	Mask: 0001h	Bit	
			internal	Mask: 0002h	Bit	
			internal	Mask: 0004h	Bit	
			11.07 Active second	Mask: 0008h	Bit	LS-5x1 v2, LS-5x2 v2
			11.06 Active minute	Mask: 0010h	Bit	LS-5x1 v2, LS-5x2 v2
			11.05 Active hour	Mask: 0020h	Bit	LS-5x1 v2, LS-5x2 v2
			11.04 Active day in month	Mask: 0040h	Bit	LS-5x1 v2, LS-5x2 v2
			11.03 Active weekday	Mask: 0080h	Bit	LS-5x1 v2, LS-5x2 v2
			11.02 Time 2 overrun	Mask: 0100h	Bit	LS-5x1 v2, LS-5x2 v2
			11.01 Time 1 overrun	Mask: 0200h	Bit	LS-5x1 v2, LS-5x2 v2
			internal	Mask: 0400h	Bit	
			04.05 Acknowledge was executed	Mask: 0800h	Bit	LS-5x1 v2, LS-5x2 v2
			01.09 Shutdown alarms are active (alarm class C-F)	Mask: 1000h	Bit	LS-5x1 v2, LS-5x2 v2
			internal	Mask: 2000h	Bit	

Appendix

Data Protocols > Modbus > Data Protocol 5300 (Basic ...

Modbus		Parameter ID	Description	Multiplier	Units	Model
Modicon start addr.	Start addr. (*1)					
			internal	Mask: 4000h	Bit	
			internal	Mask: 8000h	Bit	
450063	450062	10147	LogicsManagerBits1			
			internal	Mask: 0001h	Bit	
			internal	Mask: 0002h	Bit	
			internal	Mask: 0004h	Bit	
			internal	Mask: 0008h	Bit	
			internal	Mask: 0010h	Bit	
			internal	Mask: 0020h	Bit	
			internal	Mask: 0040h	Bit	
			internal	Mask: 0080h	Bit	
			internal	Mask: 0100h	Bit	
			internal	Mask: 0200h	Bit	
			00.46 LM Relay 6	Mask: 0400h	Bit	LS-5x1 v2, LS-5x2 v2
			internal	Mask: 0800h	Bit	
			00.44 LM Relay 4	Mask: 1000h	Bit	LS-5x1 v2, LS-5x2 v2
			00.43 LM Relay 3	Mask: 2000h	Bit	LS-5x1 v2, LS-5x2 v2
			00.42 LM Relay 2	Mask: 4000h	Bit	LS-5x1 v2, LS-5x2 v2
			00.41 LM Relay 1	Mask: 8000h	Bit	LS-5x1 v2, LS-5x2 v2
450064	450063	10140	LogicsManagerBits2			
			internal	Mask: 0001h	Bit	
			00.17 LM Operation mode MANUAL	Mask: 0002h	Bit	LS-5x1 v2, LS-5x2 v2
			00.16 LM Operation mode AUTOMATIC	Mask: 0004h	Bit	LS-5x1 v2, LS-5x2 v2
			internal	Mask: 0008h	Bit	
			00.15 LM External acknowledge	Mask: 0010h	Bit	LS-5x1 v2, LS-5x2 v2
			internal	Mask: 0020h	Bit	
			internal	Mask: 0040h	Bit	
			internal	Mask: 0080h	Bit	
			00.08 LM Internal flag 8	Mask: 0100h	Bit	LS-5x1 v2, LS-5x2 v2
			00.07 LM Internal flag 7	Mask: 0200h	Bit	LS-5x1 v2, LS-5x2 v2
			00.06 LM Internal flag 6	Mask: 0400h	Bit	LS-5x1 v2, LS-5x2 v2

Modbus		Parameter ID	Description	Multiplier	Units	Model
Modicon start addr.	Start addr. (*1)					
			00.05 LM Internal flag 5	Mask: 0800h	Bit	LS-5x1 v2, LS-5x2 v2
			00.04 LM Internal flag 4	Mask: 1000h	Bit	LS-5x1 v2, LS-5x2 v2
			00.03 LM Internal flag 3	Mask: 2000h	Bit	LS-5x1 v2, LS-5x2 v2
			00.02 LM Internal flag 2	Mask: 4000h	Bit	LS-5x1 v2, LS-5x2 v2
			00.01 LM Internal flag 1	Mask: 8000h	Bit	LS-5x1 v2, LS-5x2 v2
450065	450064	10148	LogicsManagerBits3			
			internal	Mask: 0001h	Bit	
			internal	Mask: 0002h	Bit	
			internal	Mask: 0004h	Bit	
			internal	Mask: 0008h	Bit	
			internal	Mask: 0010h	Bit	
			internal	Mask: 0020h	Bit	
			internal	Mask: 0040h	Bit	
			internal	Mask: 0080h	Bit	
			01.08 Warning alarms are active (alarm class A, B)	Mask: 0100h	Bit	LS-5x1 v2, LS-5x2 v2
			01.07 All alarm classes are active	Mask: 0200h	Bit	LS-5x1 v2, LS-5x2 v2
			01.10 Centralized alarms are active (alarm class B-F)	Mask: 0400h	Bit	LS-5x1 v2, LS-5x2 v2
			04.04 Lamp test	Mask: 0800h	Bit	LS-5x1 v2, LS-5x2 v2
			internal	Mask: 1000h	Bit	
			internal	Mask: 2000h	Bit	
			internal	Mask: 4000h	Bit	
			internal	Mask: 8000h	Bit	
450066	450065	10150	LogicsManagerBits4			
			internal	Mask: 0001h	Bit	
			internal	Mask: 0002h	Bit	
			00.37 LM Internal flag 16	Mask: 0004h	Bit	LS-5x1 v2, LS-5x2 v2
			00.36 LM Internal flag 15	Mask: 0008h	Bit	LS-5x1 v2, LS-5x2 v2
			00.35 LM Internal flag 14	Mask: 0010h	Bit	LS-5x1 v2, LS-5x2 v2
			00.34 LM Internal flag 13	Mask: 0020h	Bit	LS-5x1 v2, LS-5x2 v2
			00.33 LM Internal flag 12	Mask: 0040h	Bit	LS-5x1 v2, LS-5x2 v2

Appendix

Data Protocols > Modbus > Data Protocol 5300 (Basic ...

Modbus		Parameter ID	Description	Multiplier	Units	Model
Mod- icon start addr.	Start addr. (*1)					
			00.32 LM Internal flag 11	Mask: 0080h	Bit	LS-5x1 v2, LS-5x2 v2
			00.31 LM Internal flag 10	Mask: 0100h	Bit	LS-5x1 v2, LS-5x2 v2
			00.30 LM Internal flag 9	Mask: 0200h	Bit	LS-5x1 v2, LS-5x2 v2
			internal	Mask: 0400h	Bit	
			internal	Mask: 0800h	Bit	
			internal	Mask: 1000h	Bit	
			internal	Mask: 2000h	Bit	
			internal	Mask: 4000h	Bit	
			internal	Mask: 8000h	Bit	
450067	450066	10162	LogicsManagerBits6			
			00.40 LM Synchronization mode RUN	Mask: 0001h	Bit	LS-5x1 v2, LS-5x2 v2
			00.39 LM Synchronization mode PERMISSIVE	Mask: 0002h	Bit	LS-5x1 v2, LS-5x2 v2
			00.38 LM Synchronization mode CHECK	Mask: 0004h	Bit	LS-5x1 v2, LS-5x2 v2
			internal	Mask: 0008h	Bit	
			internal	Mask: 0010h	Bit	
			internal	Mask: 0020h	Bit	
			internal	Mask: 0040h	Bit	
			internal	Mask: 0080h	Bit	
			internal	Mask: 0100h	Bit	
			internal	Mask: 0200h	Bit	
			internal	Mask: 0400h	Bit	
			internal	Mask: 0800h	Bit	
			internal	Mask: 1000h	Bit	
			internal	Mask: 2000h	Bit	
			internal	Mask: 4000h	Bit	
			internal	Mask: 8000h	Bit	
450068	450067	10136	Monitoring analog inputs			
			08.03 Battery undervoltage threshold 1	Mask: 0001h	Bit	LS-5x1 v2, LS-5x2 v2
			08.01 Battery overvoltage threshold 1	Mask: 0002h	Bit	LS-5x1 v2, LS-5x2 v2
			08.04 Battery undervoltage threshold 2	Mask: 0004h	Bit	LS-5x1 v2, LS-5x2 v2
			08.02 Battery overvoltage threshold 2	Mask: 0008h	Bit	LS-5x1 v2, LS-5x2 v2

Modbus		Parameter ID	Description	Multiplier	Units	Model
Mod- icon start addr.	Start addr. (*1)					
			internal	Mask: 0010h	Bit	
			internal	Mask: 0020h	Bit	
			internal	Mask: 0040h	Bit	
			internal	Mask: 0080h	Bit	
			internal	Mask: 0100h	Bit	
			internal	Mask: 0200h	Bit	
			internal	Mask: 0400h	Bit	
			internal	Mask: 0800h	Bit	
			internal	Mask: 1000h	Bit	
			internal	Mask: 2000h	Bit	
			internal	Mask: 4000h	Bit	
			internal	Mask: 8000h	Bit	
450069	450068	4139	Monitoring operation windows			
			internal	Mask: 0001h	Bit	
			internal	Mask: 0002h	Bit	
			internal	Mask: 0004h	Bit	
			internal	Mask: 0008h	Bit	
			internal	Mask: 0010h	Bit	
			internal	Mask: 0020h	Bit	
			02.11 System A voltage and frequency in range (Ready for operation, 02.09 AND 02.10 are TRUE)	Mask: 0040h	Bit	LS-5x1 v2, LS-5x2 v2
			internal	Mask: 0080h	Bit	
			internal	Mask: 0100h	Bit	
			02.10 System A frequency in range (Based on System B frequency window)	Mask: 0200h	Bit	LS-5x1 v2, LS-5x2 v2
			internal	Mask: 0400h	Bit	
			internal	Mask: 0800h	Bit	
			02.09 System A voltage in range (Based on System B voltage window)	Mask: 1000h	Bit	LS-5x1 v2, LS-5x2 v2
			02.05 System B voltage and frequency in range (Ready for operation, 02.03 AND 02.04 are TRUE)	Mask: 2000h	Bit	LS-5x1 v2, LS-5x2 v2
			02.04 System B frequency in range (Based on System A Operating frequency window)	Mask: 4000h	Bit	LS-5x1 v2, LS-5x2 v2

Appendix

Data Protocols > Modbus > Data Protocol 5300 (Basic ...

Modbus		Parameter ID	Description	Multiplier	Units	Model
Mod- icon start addr.	Start addr. (*1)					
			02.03 System B voltage in range (Based on System A Operating voltage window)	Mask: 8000h	Bit	LS-5x1 v2, LS-5x2 v2
450070	450069	1791	Monitoring System A			
			internal	Mask: 0001h	Bit	
			internal	Mask: 0002h	Bit	
			internal	Mask: 0004h	Bit	
			internal	Mask: 0008h	Bit	
			internal	Mask: 0010h	Bit	
			internal	Mask: 0020h	Bit	
			02.13 System A phase rotation Clock Wise (CW, forward, right turn)	Mask: 0040h	Bit	LS-5x1 v2, LS-5x2 v2
			02.12 System A phase rotation Counter Clock Wise (CCW, reverse, left turn)	Mask: 0080h	Bit	LS-5x1 v2, LS-5x2 v2
			internal	Mask: 0100h	Bit	
			internal	Mask: 0200h	Bit	
			internal	Mask: 0400h	Bit	
			internal	Mask: 0800h	Bit	
			internal	Mask: 1000h	Bit	
			internal	Mask: 2000h	Bit	
			internal	Mask: 4000h	Bit	
internal	Mask: 8000h	Bit				
450071	450070	1792	Monitoring System B			
			internal	Mask: 0001h	Bit	
			internal	Mask: 0002h	Bit	
			internal	Mask: 0004h	Bit	
			internal	Mask: 0008h	Bit	
			internal	Mask: 0010h	Bit	
			internal	Mask: 0020h	Bit	
			02.15 System B phase rotation Clock Wise (CW, forward, right turn)	Mask: 0040h	Bit	LS-5x1 v2, LS-5x2 v2
			02.14 System B phase rotation Counter Clock Wise (CCW, reverse, left turn)	Mask: 0080h	Bit	LS-5x1 v2, LS-5x2 v2
			internal	Mask: 0100h	Bit	
			internal	Mask: 0200h	Bit	
			internal	Mask: 0400h	Bit	

Modbus		Parameter ID	Description	Multiplier	Units	Model
Modicon start addr.	Start addr. (*1)					
			internal	Mask: 0800h	Bit	
			internal	Mask: 1000h	Bit	
			internal	Mask: 2000h	Bit	
			internal	Mask: 4000h	Bit	
			internal	Mask: 8000h	Bit	
450072	450071		reserved			
450073	450072	4153	ControlBits1			
			04.01 Operating mode AUTOMATIC	Mask: 0001h	Bit	LS-5x1 v2, LS-5x2 v2
			04.03 Operating mode MANUAL	Mask: 0002h	Bit	LS-5x1 v2, LS-5x2 v2
			04.04 Lamp test request	Mask: 0004h	Bit	LS-5x1 v2, LS-5x2 v2
			04.07 CB A is closed	Mask: 0008h	Bit	LS-5x1 v2, LS-5x2 v2
			24.39 Isolation switch is open	Mask: 0010h	Bit	LS-5x1 v2, LS-5x2 v2
			04.11 Mains settling is active	Mask: 0020h	Bit	LS-5x1 v2, LS-5x2 v2
			04.18 Synchronisation CB B procedure is active	Mask: 0040h	Bit	LS-5x2 v2
			04.19 Open command CB B is active	Mask: 0080h	Bit	LS-5x2 v2
			04.20 Close command CB B is active	Mask: 0100h	Bit	LS-5x2 v2
			04.21 Synchronization CB A procedure is active	Mask: 0200h	Bit	LS-5x1 v2, LS-5x2 v2
			04.22 Open command CB A is active	Mask: 0400h	Bit	LS-5x1 v2, LS-5x2 v2
			04.23 Close command CB A is active	Mask: 0800h	Bit	LS-5x1 v2, LS-5x2 v2
			04.28 Unloading CB B is active	Mask: 1000h	Bit	LS-5x2 v2
			04.29 Unloading CB A is active	Mask: 2000h	Bit	LS-5x1 v2, LS-5x2 v2
450074	450073	4154	ControlBits2			
			Initialization CB A closure counter	Mask: 0001h	Bit	LS-5x1 v2, LS-5x2 v2
			04.62 Dead bus closure procedure is active	Mask: 0002h	Bit	LS-5x1 v2, LS-5x2 v2
			04.61 Synchronous mains closure procedure is active	Mask: 0004h	Bit	LS-5x1 v2, LS-5x2 v2
			28.01 Command 1 to LS5 (OR'ed) cf. ID8018	Mask: 0008h	Bit	LS-5x1 v2, LS-5x2 v2
			28.02 Command 2to LS5 (OR'ed) cf. ID8018	Mask: 0010h	Bit	LS-5x1 v2, LS-5x2 v2

Appendix

Data Protocols > Modbus > Data Protocol 5300 (Basic ...

Modbus		Parameter ID	Description	Multiplier	Units	Model
Modicon start addr.	Start addr. (*1)					
			28.03 Command 3to LS5 (OR'ed) cf. ID8018	Mask: 0020h	Bit	LS-5x1 v2, LS-5x2 v2
			28.04 Command 4to LS5 (OR'ed) cf. ID8018	Mask: 0040h	Bit	LS-5x1 v2, LS-5x2 v2
			28.05 Command 5to LS5 (OR'ed) cf. ID8018	Mask: 0080h	Bit	LS-5x1 v2, LS-5x2 v2
			28.06 Command 6to LS5 (OR'ed) cf. ID8018	Mask: 0100h	Bit	LS-5x1 v2, LS-5x2 v2
			Mains at "left" position (directly or isolation switch) for Toolkit grid indication	Mask: 0200h	Bit	LS-5x1 v2, LS-5x2 v2
			Mains at "right" position (directly or isolation switch) for Toolkit grid indication	Mask: 0400h	Bit	LS-5x1 v2, LS-5x2 v2
			System A mains connected	Mask: 0800h	Bit	LS-5x1 v2, LS-5x2 v2
			System B mains connected	Mask: 1000h	Bit	LS-5x1 v2, LS-5x2 v2
			02.25 Mains parallel operation	Mask: 2000h	Bit	LS-5x1 v2, LS-5x2 v2
			02.24 System B is dead	Mask: 4000h	Bit	LS-5x1 v2, LS-5x2 v2
			02.23 System A is dead	Mask: 8000h	Bit	LS-5x1 v2, LS-5x2 v2
450075	450074	4155	ControlBits3			
			internal	Mask: 0001h	Bit	
			internal	Mask: 0002h	Bit	
			internal	Mask: 0004h	Bit	
			internal	Mask: 0008h	Bit	
			internal	Mask: 0010h	Bit	
			internal	Mask: 0020h	Bit	
			internal	Mask: 0040h	Bit	
			internal	Mask: 0080h	Bit	
			internal	Mask: 0100h	Bit	
			internal	Mask: 0200h	Bit	
			internal	Mask: 0400h	Bit	
			internal	Mask: 0800h	Bit	
			System A Phase rotation CW (ToolKit)	Mask: 1000h	Bit	LS-5x1 v2, LS-5x2 v2
			System A Phase rotation CCW (ToolKit)	Mask: 2000h	Bit	LS-5x1 v2, LS-5x2 v2
			System B Phase rotation CW (ToolKit)	Mask: 4000h	Bit	LS-5x1 v2, LS-5x2 v2
			System B Phase rotation CCW (ToolKit)	Mask: 8000h	Bit	LS-5x1 v2, LS-5x2 v2
450076	450075	10191	LogicsManagerBits10			

Modbus		Parameter ID	Description	Multiplier	Units	Model
Mod- icon start addr.	Start addr. (*1)					
			24.31 Enable mains decoupling	Mask: 0001h	Bit	LS-5x1 v2, LS-5x2 v2
			24.32 Open CB A	Mask: 0002h	Bit	LS-5x1 v2, LS-5x2 v2
			24.33 Immediate open CB A	Mask: 0004h	Bit	LS-5x1 v2, LS-5x2 v2
			24.34 Enable to close CB A	Mask: 0008h	Bit	LS-5x1 v2, LS-5x2 v2
			24.35 Open CB B	Mask: 0010h	Bit	LS-5x2 v2
			24.36 Immediate open CB B	Mask: 0020h	Bit	LS-5x2 v2
			24.37 Enable to close CB B	Mask: 0040h	Bit	LS-5x2 v2
			24.38 LM variable system is A	Mask: 0080h	Bit	LS-5x2 v2
			24.41 Flag 1 LS 5	Mask: 0100h	Bit	LS-5x1 v2, LS-5x2 v2
			24.42 Flag 2 LS 5	Mask: 0200h	Bit	LS-5x1 v2, LS-5x2 v2
			24.43 Flag 3 LS 5	Mask: 0400h	Bit	LS-5x1 v2, LS-5x2 v2
			24.44 Flag 4 LS 5	Mask: 0800h	Bit	LS-5x1 v2, LS-5x2 v2
			24.45 Flag 5 LS 5	Mask: 1000h	Bit	LS-5x1 v2, LS-5x2 v2
			internal	Mask: 2000h	Bit	
			internal	Mask: 4000h	Bit	
			internal	Mask: 8000h	Bit	
450077	450076	10138	Monitoring System B			
			internal	Mask: 0001h	Bit	
			internal	Mask: 0002h	Bit	
			internal	Mask: 0004h	Bit	
			internal	Mask: 0008h	Bit	
			internal	Mask: 0010h	Bit	
			internal	Mask: 0020h	Bit	
			internal	Mask: 0040h	Bit	
			internal	Mask: 0080h	Bit	
			08.46 CB B unload mismatch	Mask: 0100h	Bit	LS-5x2 v2
			internal	Mask: 0200h	Bit	
			06.21 System B phase rotation	Mask: 0400h	Bit	LS-5x1 v2, LS-5x2 v2
			internal	Mask: 0800h	Bit	
			internal	Mask: 1000h	Bit	
			internal	Mask: 2000h	Bit	
			internal	Mask: 4000h	Bit	

Appendix

Data Protocols > Modbus > Data Protocol 5300 (Basic ...

Modbus		Parameter ID	Description	Multiplier	Units	Model
Mod- icon start addr.	Start addr. (*1)					
			internal	Mask: 8000h	Bit	
450078	450077	10135	Monitoring System A			
			internal	Mask: 0001h	Bit	
			internal	Mask: 0002h	Bit	
			07.05 System A phase rotation	Mask: 0004h	Bit	LS-5x1 v2, LS-5x2 v2
			07.26 System A voltage asymmetry (with negative sequence)	Mask: 0008h	Bit	LS-5x1 v2, LS-5x2 v2
			internal	Mask: 0010h	Bit	
			internal	Mask: 0020h	Bit	
			07.25 System A decoupling	Mask: 0040h	Bit	LS-5x1 v2, LS-5x2 v2
			07.14 System A phase shift	Mask: 0080h	Bit	LS-5x1 v2, LS-5x2 v2
			07.13 System A undervoltage threshold 2	Mask: 0100h	Bit	LS-5x1 v2, LS-5x2 v2
			07.12 System A undervoltage threshold 1	Mask: 0200h	Bit	LS-5x1 v2, LS-5x2 v2
			07.11 System A overvoltage threshold 2	Mask: 0400h	Bit	LS-5x1 v2, LS-5x2 v2
			07.10 System A overvoltage threshold 1	Mask: 0800h	Bit	LS-5x1 v2, LS-5x2 v2
			07.09 System A underfrequency threshold 2	Mask: 1000h	Bit	LS-5x1 v2, LS-5x2 v2
			07.08 System A underfrequency threshold 1	Mask: 2000h	Bit	LS-5x1 v2, LS-5x2 v2
			07.07 System A overfrequency threshold 2	Mask: 4000h	Bit	LS-5x1 v2, LS-5x2 v2
07.06 System A overfrequency threshold 1	Mask: 8000h	Bit	LS-5x1 v2, LS-5x2 v2			
450079	450078	4138	Monitoring System A			
			07.30 QV Monitoring step 2 tripped	Mask: 0001h	Bit	LS-5x1 v2, LS-5x2 v2
			07.29 QV Monitoring step 1 tripped	Mask: 0002h	Bit	LS-5x1 v2, LS-5x2 v2
			08.36 CB A unload mismatch	Mask: 0004h	Bit	LS-5x1 v2, LS-5x2 v2
			07.27 System A voltage increase	Mask: 0008h	Bit	LS-5x1 v2, LS-5x2 v2
			internal	Mask: 0010h	Bit	
			07.28 System A time-dependent voltage	Mask: 0020h	Bit	LS-5x1 v2, LS-5x2 v2
			intern	Mask: 0040h	Bit	
			07.15 df/dt (ROCOF)	Mask: 0080h	Bit	LS-5x1 v2, LS-5x2 v2
			internal	Mask: 0100h	Bit	

Modbus		Parameter ID	Description	Multiplier	Units	Model
Mod- icon start addr.	Start addr. (*1)					
			internal	Mask: 0200h	Bit	
			internal	Mask: 0400h	Bit	
			internal	Mask: 0800h	Bit	
			internal	Mask: 1000h	Bit	
			internal	Mask: 2000h	Bit	
			internal	Mask: 4000h	Bit	
			internal	Mask: 8000h	Bit	
450080	450079	534	Visualization remote and CB-Control with CAN input			
			04.44 Remote control bit 1	Mask: 0001h	Bit	LS-5x1 v2, LS-5x2 v2
			04.45 Remote control bit 2	Mask: 0002h	Bit	LS-5x1 v2, LS-5x2 v2
			04.46 Remote control bit 3	Mask: 0004h	Bit	LS-5x1 v2, LS-5x2 v2
			04.47 Remote control bit 4	Mask: 0008h	Bit	LS-5x1 v2, LS-5x2 v2
			04.48 Remote control bit 5	Mask: 0010h	Bit	LS-5x1 v2, LS-5x2 v2
			04.49 Remote control bit 6	Mask: 0020h	Bit	LS-5x1 v2, LS-5x2 v2
			04.50 Remote control bit 7	Mask: 0040h	Bit	LS-5x1 v2, LS-5x2 v2
			04.51 Remote control bit 8	Mask: 0080h	Bit	LS-5x1 v2, LS-5x2 v2
			04.52 Remote control bit 9	Mask: 0100h	Bit	LS-5x1 v2, LS-5x2 v2
			04.53 Remote control bit 10	Mask: 0200h	Bit	LS-5x1 v2, LS-5x2 v2
			04.54 Remote control bit 11	Mask: 0400h	Bit	LS-5x1 v2, LS-5x2 v2
			04.55 Remote control bit 12	Mask: 0800h	Bit	LS-5x1 v2, LS-5x2 v2
			04.56 Remote control bit 13	Mask: 1000h	Bit	LS-5x1 v2, LS-5x2 v2
			04.57 Remote control bit 14	Mask: 2000h	Bit	LS-5x1 v2, LS-5x2 v2
			04.58 Remote control bit 15	Mask: 4000h	Bit	LS-5x1 v2, LS-5x2 v2
			04.59 Remote control bit 16	Mask: 8000h	Bit	LS-5x1 v2, LS-5x2 v2
450081	450080	4150	internal	Mask: 0001h	Bit	
			internal	Mask: 0002h	Bit	
			internal	Mask: 0004h	Bit	
			internal	Mask: 0008h	Bit	
			internal	Mask: 0010h	Bit	

Appendix

Data Protocols > Modbus > Data Protocol 5300 (Basic ...

Modbus		Parameter ID	Description	Multiplier	Units	Model
Mod- icon start addr.	Start addr. (*1)					
			internal	Mask: 0020h	Bit	
			internal	Mask: 0040h	Bit	
			internal	Mask: 0080h	Bit	
			internal	Mask: 0100h	Bit	
			internal	Mask: 0200h	Bit	
			02.30 Dead Bus closure condition	Mask: 0400h	Bit	LS-5x1 v2, LS-5x2 v2
			02.29 Sync. condition	Mask: 0800h	Bit	LS-5x1 v2, LS-5x2 v2
			02.28 Sync. check relay	Mask: 1000h	Bit	LS-5x1 v2, LS-5x2 v2
			internal	Mask: 2000h	Bit	
			04.63 Synchronous segment closure procedure is active	Mask: 4000h	Bit	LS-5x1 v2, LS-5x2 v2
			internal	Mask: 8000h	Bit	
450082	450081		reserved			
450083	450082		reserved			
450084	450083		reserved			
450085	450084		reserved			
450086	450085		reserved			
450087	450086		reserved			
450088	450087		reserved			
450089	450088		reserved			
450090	450089		reserved			
Discrete Outputs						
450091	450090	10107	Discrete outputs 1 to 6			
			Relay-Output 1 (inverted)	Mask: 8000h	Bit	LS-5x1 v2, LS-5x2 v2
			Relay-Output 2	Mask: 4000h	Bit	LS-5x1 v2, LS-5x2 v2
			Relay-Output 3	Mask: 2000h	Bit	LS-5x1 v2, LS-5x2 v2
			Relay-Output 4	Mask: 1000h	Bit	LS-5x1 v2, LS-5x2 v2
			Relay-Output 5	Mask: 0800h	Bit	LS-5x1 v2, LS-5x2 v2
			Relay-Output 6	Mask: 0400h	Bit	LS-5x1 v2, LS-5x2 v2
			internal	Mask: 0200h	Bit	
			internal	Mask: 0100h	Bit	
			internal	Mask: 0080h	Bit	

Modbus		Parameter ID	Description	Multiplier	Units	Model
Mod- icon start addr.	Start addr. (*1)					
			internal	Mask: 0040h	Bit	
			internal	Mask: 0020h	Bit	
			internal	Mask: 0010h	Bit	
			internal	Mask: 0008h	Bit	
			internal	Mask: 0004h	Bit	
			internal	Mask: 0002h	Bit	
			internal	Mask: 0001h	Bit	
450092	450091		reserved			
450093	450092		reserved			
Alarm Management						
450094	450093	10131	Alarm class latched			
			internal	Mask: 8000h	Bit	
			internal	Mask: 4000h	Bit	
			internal	Mask: 2000h	Bit	
			internal	Mask: 1000h	Bit	
			internal	Mask: 0800h	Bit	
			internal	Mask: 0400h	Bit	
			internal	Mask: 0200h	Bit	
			internal	Mask: 0100h	Bit	
			internal	Mask: 0080h	Bit	
			internal	Mask: 0040h	Bit	
			Alarm class F latched	Mask: 0020h	Bit	LS-5x1 v2, LS-5x2 v2
			Alarm class E latched	Mask: 0010h	Bit	LS-5x1 v2, LS-5x2 v2
			Alarm class D latched	Mask: 0008h	Bit	LS-5x1 v2, LS-5x2 v2
			Alarm class C latched	Mask: 0004h	Bit	LS-5x1 v2, LS-5x2 v2
			Alarm class B latched	Mask: 0002h	Bit	LS-5x1 v2, LS-5x2 v2
			Alarm class A latched	Mask: 0001h	Bit	LS-5x1 v2, LS-5x2 v2
450095	450094	10160	LogicsManagerBits5			
			internal	Mask: 8000h	Bit	
			internal	Mask: 4000h	Bit	
			internal	Mask: 2000h	Bit	
			internal	Mask: 1000h	Bit	

Appendix

Data Protocols > Modbus > Data Protocol 5300 (Basic ...

Modbus		Parameter ID	Description	Multiplier	Units	Model
Mod- icon start addr.	Start addr. (*1)					
			internal	Mask: 0800h	Bit	
			internal	Mask: 0400h	Bit	
			internal	Mask: 0200h	Bit	
			internal	Mask: 0100h	Bit	
			internal	Mask: 0080h	Bit	
			internal	Mask: 0040h	Bit	
			internal	Mask: 0020h	Bit	
			internal	Mask: 0010h	Bit	
			internal	Mask: 0008h	Bit	
			internal	Mask: 0004h	Bit	
			01.11 New alarm triggered	Mask: 0002h	Bit	LS-5x1 v2, LS-5x2 v2
			internal	Mask: 0001h	Bit	
450096	450095	10149	Alarm2			
			08.30 Timeout synchronization CB B	Mask: 8000h	Bit	LS-5x2 v2
			08.31 Timeout synchronization CB A	Mask: 4000h	Bit	LS-5x1 v2, LS-5x2 v2
			internal	Mask: 2000h	Bit	
			internal	Mask: 1000h	Bit	
			08.33 System A / System B phase rotation mismatch	Mask: 0800h	Bit	LS-5x1 v2, LS-5x2 v2
			reserved	Mask: 0400h	Bit	
			internal	Mask: 0200h	Bit	
			internal	Mask: 0100h	Bit	
			internal	Mask: 0080h	Bit	
			internal	Mask: 0040h	Bit	
			internal	Mask: 0020h	Bit	
			internal	Mask: 0010h	Bit	
			08.17 Number of member mismatch	Mask: 0008h	Bit	LS-5x1 v2, LS-5x2 v2
			05.15 EEPROM corrupted	Mask: 0004h	Bit	LS-5x1 v2, LS-5x2 v2
			internal	Mask: 0002h	Bit	
			internal	Mask: 0001h	Bit	
450097	450096	10133	Alarm1			
			internal	Mask: 8000h	Bit	
			internal	Mask: 4000h	Bit	
			internal	Mask: 2000h	Bit	

Modbus		Parameter ID	Description	Multiplier	Units	Model
Modicon start addr.	Start addr. (*1)					
			internal	Mask: 1000h	Bit	
			internal	Mask: 0800h	Bit	
			internal	Mask: 0400h	Bit	
			internal	Mask: 0200h	Bit	
			08.05 CB B close not successful	Mask: 0100h	Bit	LS-5x2 v2
			08.06 CB B open not successful	Mask: 0080h	Bit	LS-5x2 v2
			08.07 CB A close not successful	Mask: 0040h	Bit	LS-5x1 v2, LS-5x2 v2
			08.08 CB A open not successful	Mask: 0020h	Bit	LS-5x1 v2, LS-5x2 v2
			internal	Mask: 0010h	Bit	
			internal	Mask: 0008h	Bit	
			internal	Mask: 0004h	Bit	
			internal	Mask: 0002h	Bit	
			08.18 CANopen error interface 1	Mask: 0001h	Bit	LS-5x1 v2, LS-5x2 v2
450098	450097		reserved			
450099	450098		reserved			
450100	450099		reserved			
450101	450100		reserved			
450102	450101	10202	States display	see operation		LS-5x1 v2, LS-5x2 v2
450103	450102		reserved			
450104	450103	4153	ControlBits1 (see above)			LS-5x1 v2, LS-5x2 v2
450105	450104	4154	ControlBits2 (see above)			LS-5x1 v2, LS-5x2 v2
450106	450105	4155	ControlBits3 (see above)			LS-5x1 v2, LS-5x2 v2
450107	450106		reserved			
450108	450107		reserved			
System A						
450109	450108		reserved			
450110	450109		reserved			
System B						
450111	450110		reserved			
450112	450111		reserved			
Discrete Inputs						
450113	450112	10132	Alarms discrete inputs 1 latched (unacknowledged)			

Modbus		Parameter ID	Description	Multiplier	Units	Model
Mod- icon start addr.	Start addr. (*1)					
		10608	State Discrete Input 8 (reply CB A)	Mask: 8000h	Bit	LS-5x1 v2, LS-5x2 v2
		10607	State Discrete Input 7	Mask: 4000h	Bit	LS-5x1 v2, LS-5x2 v2
		10605	State Discrete Input 6	Mask: 2000h	Bit	LS-5x1 v2, LS-5x2 v2
		10604	State Discrete Input 5	Mask: 1000h	Bit	LS-5x1 v2, LS-5x2 v2
		10603	State Discrete Input 4	Mask: 0800h	Bit	LS-5x1 v2, LS-5x2 v2
		10602	State Discrete Input 3	Mask: 0400h	Bit	LS-5x1 v2, LS-5x2 v2
		10601	State Discrete Input 2	Mask: 0200h	Bit	LS-5x1 v2, LS-5x2 v2
		10600	State Discrete Input 1	Mask: 0100h	Bit	LS-5x1 v2, LS-5x2 v2
			internal	Mask: 0080h	Bit	
			internal	Mask: 0040h	Bit	
			internal	Mask: 0020h	Bit	
			internal	Mask: 0010h	Bit	
			internal	Mask: 0008h	Bit	
			internal	Mask: 0004h	Bit	
			internal	Mask: 0002h	Bit	
			internal	Mask: 0001h	Bit	
450114	450113		reserved			
450115	450114		reserved			
450116	450115		reserved			
450117	450116		reserved			
DC Analogue Values Wirebreak						
450118	450117	10137	Alarms analog inputs wire break latched (unacknowledged)			
			internal	Mask: 0001h	Bit	
			10.01 Analog input 1, wire break	Mask: 0002h	Bit	LS-5x2 v2
			internal	Mask: 0004h	Bit	
			internal	Mask: 0008h	Bit	
			internal	Mask: 0010h	Bit	
			internal	Mask: 0020h	Bit	
			internal	Mask: 0040h	Bit	
			internal	Mask: 0080h	Bit	
			internal	Mask: 0100h	Bit	

Modbus		Parameter ID	Description	Multiplier	Units	Model
Modicon start addr.	Start addr. (*1)					
			internal	Mask: 0200h	Bit	
			internal	Mask: 0400h	Bit	
			internal	Mask: 0800h	Bit	
			internal	Mask: 1000h	Bit	
			internal	Mask: 2000h	Bit	
			internal	Mask: 4000h	Bit	
			internal	Mask: 8000h	Bit	
450119	450118		reserved			
450120	450119		reserved			
easYgen-3000 or easYgen-3000XT Controls						
450121	450120		Status of Device 1			
			Generator voltage and frequency ok	Mask: 0001h	Bit	LS-5x1 v2, LS-5x2 v2
			Busbar voltage and frequency ok	Mask: 0002h	Bit	LS-5x1 v2, LS-5x2 v2
			Mains voltage and frequency ok	Mask: 0004h	Bit	LS-5x1 v2, LS-5x2 v2
			4th system voltage and frequency ok	Mask: 0008h	Bit	LS-5x1 v2, LS-5x2 v2
			Busbar 1 dead busbar detection	Mask: 0010h	Bit	LS-5x1 v2, LS-5x2 v2
			Busbar 2 dead busbar detection	Mask: 0020h	Bit	LS-5x1 v2, LS-5x2 v2
			internal	Mask: 0040h	Bit	
			internal	Mask: 0080h	Bit	
			29.01 Command to CB-control 1	Mask: 0100h	Bit	LS-5x1 v2, LS-5x2 v2
			29.02 Command to CB-control 2	Mask: 0200h	Bit	LS-5x1 v2, LS-5x2 v2
			29.03 Command to CB-control 3	Mask: 0400h	Bit	LS-5x1 v2, LS-5x2 v2
			29.04 Command to CB-control 4	Mask: 0800h	Bit	LS-5x1 v2, LS-5x2 v2
			29.05 Command to CB-control 5	Mask: 1000h	Bit	LS-5x1 v2, LS-5x2 v2
			29.06 Command to CB-control 6	Mask: 2000h	Bit	LS-5x1 v2, LS-5x2 v2
			internal	Mask: 4000h	Bit	
			internal	Mask: 8000h	Bit	
450122	450121		Status of Device 2			
			Generator voltage and frequency ok	Mask: 0001h	Bit	LS-5x1 v2, LS-5x2 v2
			Busbar voltage and frequency ok	Mask: 0002h	Bit	LS-5x1 v2, LS-5x2 v2

Appendix

Data Protocols > Modbus > Data Protocol 5300 (Basic ...

Modbus		Parameter ID	Description	Multiplier	Units	Model
Modicon start addr.	Start addr. (*1)					
			Mains voltage and frequency ok	Mask: 0004h	Bit	LS-5x1 v2, LS-5x2 v2
			4th system voltage and frequency ok	Mask: 0008h	Bit	LS-5x1 v2, LS-5x2 v2
			Busbar 1 dead busbar detection	Mask: 0010h	Bit	LS-5x1 v2, LS-5x2 v2
			Busbar 2 dead busbar detection	Mask: 0020h	Bit	LS-5x1 v2, LS-5x2 v2
			internal	Mask: 0040h	Bit	
			internal	Mask: 0080h	Bit	
			29.01 Command to CB-control 1	Mask: 0100h	Bit	LS-5x1 v2, LS-5x2 v2
			29.02 Command to CB-control 2	Mask: 0200h	Bit	LS-5x1 v2, LS-5x2 v2
			29.03 Command to CB-control 3	Mask: 0400h	Bit	LS-5x1 v2, LS-5x2 v2
			29.04 Command to CB-control 4	Mask: 0800h	Bit	LS-5x1 v2, LS-5x2 v2
			29.05 Command to CB-control 5	Mask: 1000h	Bit	LS-5x1 v2, LS-5x2 v2
			29.06 Command to CB-control 6	Mask: 2000h	Bit	LS-5x1 v2, LS-5x2 v2
			internal	Mask: 4000h	Bit	
			internal	Mask: 8000h	Bit	
450123	450122		Status of Device 3			
			Generator voltage and frequency ok	Mask: 0001h	Bit	LS-5x1 v2, LS-5x2 v2
			Busbar voltage and frequency ok	Mask: 0002h	Bit	LS-5x1 v2, LS-5x2 v2
			Mains voltage and frequency ok	Mask: 0004h	Bit	LS-5x1 v2, LS-5x2 v2
			4th system voltage and frequency ok	Mask: 0008h	Bit	LS-5x1 v2, LS-5x2 v2
			Busbar 1 dead busbar detection	Mask: 0010h	Bit	LS-5x1 v2, LS-5x2 v2
			Busbar 2 dead busbar detection	Mask: 0020h	Bit	LS-5x1 v2, LS-5x2 v2
			internal	Mask: 0040h	Bit	
			internal	Mask: 0080h	Bit	
			29.01 Command to CB-control 1	Mask: 0100h	Bit	LS-5x1 v2, LS-5x2 v2
			29.02 Command to CB-control 2	Mask: 0200h	Bit	LS-5x1 v2, LS-5x2 v2
			29.03 Command to CB-control 3	Mask: 0400h	Bit	LS-5x1 v2, LS-5x2 v2
			29.04 Command to CB-control 4	Mask: 0800h	Bit	LS-5x1 v2, LS-5x2 v2

Modbus		Parameter ID	Description	Multiplier	Units	Model
Modicon start addr.	Start addr. (*1)					
			29.05 Command to CB-control 5	Mask: 1000h	Bit	LS-5x1 v2, LS-5x2 v2
			29.06 Command to CB-control 6	Mask: 2000h	Bit	LS-5x1 v2, LS-5x2 v2
			internal	Mask: 4000h	Bit	
			internal	Mask: 8000h	Bit	
450124	450123		Status of Device 4			
			Generator voltage and frequency ok	Mask: 0001h	Bit	LS-5x1 v2, LS-5x2 v2
			Busbar voltage and frequency ok	Mask: 0002h	Bit	LS-5x1 v2, LS-5x2 v2
			Mains voltage and frequency ok	Mask: 0004h	Bit	LS-5x1 v2, LS-5x2 v2
			4th system voltage and frequency ok	Mask: 0008h	Bit	LS-5x1 v2, LS-5x2 v2
			Busbar 1 dead busbar detection	Mask: 0010h	Bit	LS-5x1 v2, LS-5x2 v2
			Busbar 2 dead busbar detection	Mask: 0020h	Bit	LS-5x1 v2, LS-5x2 v2
			internal	Mask: 0040h	Bit	
			internal	Mask: 0080h	Bit	
			29.01 Command to CB-control 1	Mask: 0100h	Bit	LS-5x1 v2, LS-5x2 v2
			29.02 Command to CB-control 2	Mask: 0200h	Bit	LS-5x1 v2, LS-5x2 v2
			29.03 Command to CB-control 3	Mask: 0400h	Bit	LS-5x1 v2, LS-5x2 v2
			29.04 Command to CB-control 4	Mask: 0800h	Bit	LS-5x1 v2, LS-5x2 v2
			29.05 Command to CB-control 5	Mask: 1000h	Bit	LS-5x1 v2, LS-5x2 v2
			29.06 Command to CB-control 6	Mask: 2000h	Bit	LS-5x1 v2, LS-5x2 v2
			internal	Mask: 4000h	Bit	
			internal	Mask: 8000h	Bit	
450125	450124		Status of Device 5			
			Generator voltage and frequency ok	Mask: 0001h	Bit	LS-5x1 v2, LS-5x2 v2
			Busbar voltage and frequency ok	Mask: 0002h	Bit	LS-5x1 v2, LS-5x2 v2
			Mains voltage and frequency ok	Mask: 0004h	Bit	LS-5x1 v2, LS-5x2 v2
			4th system voltage and frequency ok	Mask: 0008h	Bit	LS-5x1 v2, LS-5x2 v2
			Busbar 1 dead busbar detection	Mask: 0010h	Bit	LS-5x1 v2, LS-5x2 v2
			Busbar 2 dead busbar detection	Mask: 0020h	Bit	LS-5x1 v2, LS-5x2 v2

Appendix

Data Protocols > Modbus > Data Protocol 5300 (Basic ...

Modbus		Parameter ID	Description	Multiplier	Units	Model
Modicon start addr.	Start addr. (*1)					
			internal	Mask: 0040h	Bit	
			internal	Mask: 0080h	Bit	
			29.01 Command to CB-control 1	Mask: 0100h	Bit	LS-5x1 v2, LS-5x2 v2
			29.02 Command to CB-control 2	Mask: 0200h	Bit	LS-5x1 v2, LS-5x2 v2
			29.03 Command to CB-control 3	Mask: 0400h	Bit	LS-5x1 v2, LS-5x2 v2
			29.04 Command to CB-control 4	Mask: 0800h	Bit	LS-5x1 v2, LS-5x2 v2
			29.05 Command to CB-control 5	Mask: 1000h	Bit	LS-5x1 v2, LS-5x2 v2
			29.06 Command to CB-control 6	Mask: 2000h	Bit	LS-5x1 v2, LS-5x2 v2
			internal	Mask: 4000h	Bit	
			internal	Mask: 8000h	Bit	
450126	450125		Status of Device 6			
			Generator voltage and frequency ok	Mask: 0001h	Bit	LS-5x1 v2, LS-5x2 v2
			Busbar voltage and frequency ok	Mask: 0002h	Bit	LS-5x1 v2, LS-5x2 v2
			Mains voltage and frequency ok	Mask: 0004h	Bit	LS-5x1 v2, LS-5x2 v2
			4th system voltage and frequency ok	Mask: 0008h	Bit	LS-5x1 v2, LS-5x2 v2
			Busbar 1 dead busbar detection	Mask: 0010h	Bit	LS-5x1 v2, LS-5x2 v2
			Busbar 2 dead busbar detection	Mask: 0020h	Bit	LS-5x1 v2, LS-5x2 v2
			internal	Mask: 0040h	Bit	
			internal	Mask: 0080h	Bit	
			29.01 Command to CB-control 1	Mask: 0100h	Bit	LS-5x1 v2, LS-5x2 v2
			29.02 Command to CB-control 2	Mask: 0200h	Bit	LS-5x1 v2, LS-5x2 v2
			29.03 Command to CB-control 3	Mask: 0400h	Bit	LS-5x1 v2, LS-5x2 v2
			29.04 Command to CB-control 4	Mask: 0800h	Bit	LS-5x1 v2, LS-5x2 v2
			29.05 Command to CB-control 5	Mask: 1000h	Bit	LS-5x1 v2, LS-5x2 v2
			29.06 Command to CB-control 6	Mask: 2000h	Bit	LS-5x1 v2, LS-5x2 v2
			internal	Mask: 4000h	Bit	
			internal	Mask: 8000h	Bit	
450127	450126		Status of Device 7			

Modbus		Parameter ID	Description	Multiplier	Units	Model
Modicon start addr.	Start addr. (*1)					
			Generator voltage and frequency ok	Mask: 0001h	Bit	LS-5x1 v2, LS-5x2 v2
			Busbar voltage and frequency ok	Mask: 0002h	Bit	LS-5x1 v2, LS-5x2 v2
			Mains voltage and frequency ok	Mask: 0004h	Bit	LS-5x1 v2, LS-5x2 v2
			4th system voltage and frequency ok	Mask: 0008h	Bit	LS-5x1 v2, LS-5x2 v2
			Busbar 1 dead busbar detection	Mask: 0010h	Bit	LS-5x1 v2, LS-5x2 v2
			Busbar 2 dead busbar detection	Mask: 0020h	Bit	LS-5x1 v2, LS-5x2 v2
			internal	Mask: 0040h	Bit	
			internal	Mask: 0080h	Bit	
			29.01 Command to CB-control 1	Mask: 0100h	Bit	LS-5x1 v2, LS-5x2 v2
			29.02 Command to CB-control 2	Mask: 0200h	Bit	LS-5x1 v2, LS-5x2 v2
			29.03 Command to CB-control 3	Mask: 0400h	Bit	LS-5x1 v2, LS-5x2 v2
			29.04 Command to CB-control 4	Mask: 0800h	Bit	LS-5x1 v2, LS-5x2 v2
			29.05 Command to CB-control 5	Mask: 1000h	Bit	LS-5x1 v2, LS-5x2 v2
			29.06 Command to CB-control 6	Mask: 2000h	Bit	LS-5x1 v2, LS-5x2 v2
			internal	Mask: 4000h	Bit	
			internal	Mask: 8000h	Bit	
450128	450127		Status of Device 8			
			Generator voltage and frequency ok	Mask: 0001h	Bit	LS-5x1 v2, LS-5x2 v2
			Busbar voltage and frequency ok	Mask: 0002h	Bit	LS-5x1 v2, LS-5x2 v2
			Mains voltage and frequency ok	Mask: 0004h	Bit	LS-5x1 v2, LS-5x2 v2
			4th system voltage and frequency ok	Mask: 0008h	Bit	LS-5x1 v2, LS-5x2 v2
			Busbar 1 dead busbar detection	Mask: 0010h	Bit	LS-5x1 v2, LS-5x2 v2
			Busbar 2 dead busbar detection	Mask: 0020h	Bit	LS-5x1 v2, LS-5x2 v2
			internal	Mask: 0040h	Bit	
			internal	Mask: 0080h	Bit	
			29.01 Command to CB-control 1	Mask: 0100h	Bit	LS-5x1 v2, LS-5x2 v2
			29.02 Command to CB-control 2	Mask: 0200h	Bit	LS-5x1 v2, LS-5x2 v2

Appendix

Data Protocols > Modbus > Data Protocol 5300 (Basic ...

Modbus		Parameter ID	Description	Multiplier	Units	Model
Mod- icon start addr.	Start addr. (*1)					
			29.03 Command to CB-control 3	Mask: 0400h	Bit	LS-5x1 v2, LS-5x2 v2
			29.04 Command to CB-control 4	Mask: 0800h	Bit	LS-5x1 v2, LS-5x2 v2
			29.05 Command to CB-control 5	Mask: 1000h	Bit	LS-5x1 v2, LS-5x2 v2
			29.06 Command to CB-control 6	Mask: 2000h	Bit	LS-5x1 v2, LS-5x2 v2
			internal	Mask: 4000h	Bit	
			internal	Mask: 8000h	Bit	
450129	450128		Status of Device 9			
			Generator voltage and frequency ok	Mask: 0001h	Bit	LS-5x1 v2, LS-5x2 v2
			Busbar voltage and frequency ok	Mask: 0002h	Bit	LS-5x1 v2, LS-5x2 v2
			Mains voltage and frequency ok	Mask: 0004h	Bit	LS-5x1 v2, LS-5x2 v2
			4th system voltage and frequency ok	Mask: 0008h	Bit	LS-5x1 v2, LS-5x2 v2
			Busbar 1 dead busbar detection	Mask: 0010h	Bit	LS-5x1 v2, LS-5x2 v2
			Busbar 2 dead busbar detection	Mask: 0020h	Bit	LS-5x1 v2, LS-5x2 v2
			internal	Mask: 0040h	Bit	
			internal	Mask: 0080h	Bit	
			29.01 Command to CB-control 1	Mask: 0100h	Bit	LS-5x1 v2, LS-5x2 v2
			29.02 Command to CB-control 2	Mask: 0200h	Bit	LS-5x1 v2, LS-5x2 v2
			29.03 Command to CB-control 3	Mask: 0400h	Bit	LS-5x1 v2, LS-5x2 v2
			29.04 Command to CB-control 4	Mask: 0800h	Bit	LS-5x1 v2, LS-5x2 v2
			29.05 Command to CB-control 5	Mask: 1000h	Bit	LS-5x1 v2, LS-5x2 v2
			29.06 Command to CB-control 6	Mask: 2000h	Bit	LS-5x1 v2, LS-5x2 v2
			internal	Mask: 4000h	Bit	
			internal	Mask: 8000h	Bit	
450130	450129		Status of Device 10			
			Generator voltage and frequency ok	Mask: 0001h	Bit	LS-5x1 v2, LS-5x2 v2
			Busbar voltage and frequency ok	Mask: 0002h	Bit	LS-5x1 v2, LS-5x2 v2
			Mains voltage and frequency ok	Mask: 0004h	Bit	LS-5x1 v2, LS-5x2 v2
			4th system voltage and frequency ok	Mask: 0008h	Bit	LS-5x1 v2, LS-5x2 v2

Modbus		Parameter ID	Description	Multiplier	Units	Model
Modicon start addr.	Start addr. (*1)					
			Busbar 1 dead busbar detection	Mask: 0010h	Bit	LS-5x1 v2, LS-5x2 v2
			Busbar 2 dead busbar detection	Mask: 0020h	Bit	LS-5x1 v2, LS-5x2 v2
			internal	Mask: 0040h	Bit	
			internal	Mask: 0080h	Bit	
			29.01 Command to CB-control 1	Mask: 0100h	Bit	LS-5x1 v2, LS-5x2 v2
			29.02 Command to CB-control 2	Mask: 0200h	Bit	LS-5x1 v2, LS-5x2 v2
			29.03 Command to CB-control 3	Mask: 0400h	Bit	LS-5x1 v2, LS-5x2 v2
			29.04 Command to CB-control 4	Mask: 0800h	Bit	LS-5x1 v2, LS-5x2 v2
			29.05 Command to CB-control 5	Mask: 1000h	Bit	LS-5x1 v2, LS-5x2 v2
			29.06 Command to CB-control 6	Mask: 2000h	Bit	LS-5x1 v2, LS-5x2 v2
			internal	Mask: 4000h	Bit	
			internal	Mask: 8000h	Bit	
450131	450130		Status of Device 11			
			Generator voltage and frequency ok	Mask: 0001h	Bit	LS-5x1 v2, LS-5x2 v2
			Busbar voltage and frequency ok	Mask: 0002h	Bit	LS-5x1 v2, LS-5x2 v2
			Mains voltage and frequency ok	Mask: 0004h	Bit	LS-5x1 v2, LS-5x2 v2
			4th system voltage and frequency ok	Mask: 0008h	Bit	LS-5x1 v2, LS-5x2 v2
			Busbar 1 dead busbar detection	Mask: 0010h	Bit	LS-5x1 v2, LS-5x2 v2
			Busbar 2 dead busbar detection	Mask: 0020h	Bit	LS-5x1 v2, LS-5x2 v2
			internal	Mask: 0040h	Bit	
			internal	Mask: 0080h	Bit	
			29.01 Command to CB-control 1	Mask: 0100h	Bit	LS-5x1 v2, LS-5x2 v2
			29.02 Command to CB-control 2	Mask: 0200h	Bit	LS-5x1 v2, LS-5x2 v2
			29.03 Command to CB-control 3	Mask: 0400h	Bit	LS-5x1 v2, LS-5x2 v2
			29.04 Command to CB-control 4	Mask: 0800h	Bit	LS-5x1 v2, LS-5x2 v2
			29.05 Command to CB-control 5	Mask: 1000h	Bit	LS-5x1 v2, LS-5x2 v2
			29.06 Command to CB-control 6	Mask: 2000h	Bit	LS-5x1 v2, LS-5x2 v2
			internal	Mask: 4000h	Bit	

Modbus		Parameter ID	Description	Multiplier	Units	Model
Modicon start addr.	Start addr. (*1)					
			internal	Mask: 8000h	Bit	
450132	450131		Status of Device 12			
			Generator voltage and frequency ok	Mask: 0001h	Bit	LS-5x1 v2, LS-5x2 v2
			Busbar voltage and frequency ok	Mask: 0002h	Bit	LS-5x1 v2, LS-5x2 v2
			Mains voltage and frequency ok	Mask: 0004h	Bit	LS-5x1 v2, LS-5x2 v2
			4th system voltage and frequency ok	Mask: 0008h	Bit	LS-5x1 v2, LS-5x2 v2
			Busbar 1 dead busbar detection	Mask: 0010h	Bit	LS-5x1 v2, LS-5x2 v2
			Busbar 2 dead busbar detection	Mask: 0020h	Bit	LS-5x1 v2, LS-5x2 v2
			internal	Mask: 0040h	Bit	
			internal	Mask: 0080h	Bit	
			29.01 Command to CB-control 1	Mask: 0100h	Bit	LS-5x1 v2, LS-5x2 v2
			29.02 Command to CB-control 2	Mask: 0200h	Bit	LS-5x1 v2, LS-5x2 v2
			29.03 Command to CB-control 3	Mask: 0400h	Bit	LS-5x1 v2, LS-5x2 v2
			29.04 Command to CB-control 4	Mask: 0800h	Bit	LS-5x1 v2, LS-5x2 v2
			29.05 Command to CB-control 5	Mask: 1000h	Bit	LS-5x1 v2, LS-5x2 v2
			29.06 Command to CB-control 6	Mask: 2000h	Bit	LS-5x1 v2, LS-5x2 v2
				internal	Mask: 4000h	Bit
		internal	Mask: 8000h	Bit		
450133	450132		Status of Device 13			
			Generator voltage and frequency ok	Mask: 0001h	Bit	LS-5x1 v2, LS-5x2 v2
			Busbar voltage and frequency ok	Mask: 0002h	Bit	LS-5x1 v2, LS-5x2 v2
			Mains voltage and frequency ok	Mask: 0004h	Bit	LS-5x1 v2, LS-5x2 v2
			4th system voltage and frequency ok	Mask: 0008h	Bit	LS-5x1 v2, LS-5x2 v2
			Busbar 1 dead busbar detection	Mask: 0010h	Bit	LS-5x1 v2, LS-5x2 v2
			Busbar 2 dead busbar detection	Mask: 0020h	Bit	LS-5x1 v2, LS-5x2 v2
			internal	Mask: 0040h	Bit	
			internal	Mask: 0080h	Bit	
			29.01 Command to CB-control 1	Mask: 0100h	Bit	LS-5x1 v2, LS-5x2 v2

Modbus		Parameter ID	Description	Multiplier	Units	Model
Mod- icon start addr.	Start addr. (*1)					
			29.02 Command to CB-control 2	Mask: 0200h	Bit	LS-5x1 v2, LS-5x2 v2
			29.03 Command to CB-control 3	Mask: 0400h	Bit	LS-5x1 v2, LS-5x2 v2
			29.04 Command to CB-control 4	Mask: 0800h	Bit	LS-5x1 v2, LS-5x2 v2
			29.05 Command to CB-control 5	Mask: 1000h	Bit	LS-5x1 v2, LS-5x2 v2
			29.06 Command to CB-control 6	Mask: 2000h	Bit	LS-5x1 v2, LS-5x2 v2
			internal	Mask: 4000h	Bit	
			internal	Mask: 8000h	Bit	
450134	450133		Status of Device 14			
			Generator voltage and frequency ok	Mask: 0001h	Bit	LS-5x1 v2, LS-5x2 v2
			Busbar voltage and frequency ok	Mask: 0002h	Bit	LS-5x1 v2, LS-5x2 v2
			Mains voltage and frequency ok	Mask: 0004h	Bit	LS-5x1 v2, LS-5x2 v2
			4th system voltage and frequency ok	Mask: 0008h	Bit	LS-5x1 v2, LS-5x2 v2
			Busbar 1 dead busbar detection	Mask: 0010h	Bit	LS-5x1 v2, LS-5x2 v2
			Busbar 2 dead busbar detection	Mask: 0020h	Bit	LS-5x1 v2, LS-5x2 v2
			internal	Mask: 0040h	Bit	
			internal	Mask: 0080h	Bit	
			29.01 Command to CB-control 1	Mask: 0100h	Bit	LS-5x1 v2, LS-5x2 v2
			29.02 Command to CB-control 2	Mask: 0200h	Bit	LS-5x1 v2, LS-5x2 v2
			29.03 Command to CB-control 3	Mask: 0400h	Bit	LS-5x1 v2, LS-5x2 v2
			29.04 Command to CB-control 4	Mask: 0800h	Bit	LS-5x1 v2, LS-5x2 v2
			29.05 Command to CB-control 5	Mask: 1000h	Bit	LS-5x1 v2, LS-5x2 v2
			29.06 Command to CB-control 6	Mask: 2000h	Bit	LS-5x1 v2, LS-5x2 v2
			internal	Mask: 4000h	Bit	
			internal	Mask: 8000h	Bit	
450135	450134		Status of Device 15			
			Generator voltage and frequency ok	Mask: 0001h	Bit	LS-5x1 v2, LS-5x2 v2
			Busbar voltage and frequency ok	Mask: 0002h	Bit	LS-5x1 v2, LS-5x2 v2
			Mains voltage and frequency ok	Mask: 0004h	Bit	LS-5x1 v2, LS-5x2 v2

Modbus		Parameter ID	Description	Multiplier	Units	Model
Modicon start addr.	Start addr. (*1)					
			4th system voltage and frequency ok	Mask: 0008h	Bit	LS-5x1 v2, LS-5x2 v2
			Busbar 1 dead busbar detection	Mask: 0010h	Bit	LS-5x1 v2, LS-5x2 v2
			Busbar 2 dead busbar detection	Mask: 0020h	Bit	LS-5x1 v2, LS-5x2 v2
			internal	Mask: 0040h	Bit	
			internal	Mask: 0080h	Bit	
			29.01 Command to CB-control 1	Mask: 0100h	Bit	LS-5x1 v2, LS-5x2 v2
			29.02 Command to CB-control 2	Mask: 0200h	Bit	LS-5x1 v2, LS-5x2 v2
			29.03 Command to CB-control 3	Mask: 0400h	Bit	LS-5x1 v2, LS-5x2 v2
			29.04 Command to CB-control 4	Mask: 0800h	Bit	LS-5x1 v2, LS-5x2 v2
			29.05 Command to CB-control 5	Mask: 1000h	Bit	LS-5x1 v2, LS-5x2 v2
			29.06 Command to CB-control 6	Mask: 2000h	Bit	LS-5x1 v2, LS-5x2 v2
			internal	Mask: 4000h	Bit	
			internal	Mask: 8000h	Bit	
450136	450135		Status of Device 16			
			Generator voltage and frequency ok	Mask: 0001h	Bit	LS-5x1 v2, LS-5x2 v2
			Busbar voltage and frequency ok	Mask: 0002h	Bit	LS-5x1 v2, LS-5x2 v2
			Mains voltage and frequency ok	Mask: 0004h	Bit	LS-5x1 v2, LS-5x2 v2
			4th system voltage and frequency ok	Mask: 0008h	Bit	LS-5x1 v2, LS-5x2 v2
			Busbar 1 dead busbar detection	Mask: 0010h	Bit	LS-5x1 v2, LS-5x2 v2
			Busbar 2 dead busbar detection	Mask: 0020h	Bit	LS-5x1 v2, LS-5x2 v2
			internal	Mask: 0040h	Bit	
			internal	Mask: 0080h	Bit	
			29.01 Command to CB-control 1	Mask: 0100h	Bit	LS-5x1 v2, LS-5x2 v2
			29.02 Command to CB-control 2	Mask: 0200h	Bit	LS-5x1 v2, LS-5x2 v2
			29.03 Command to CB-control 3	Mask: 0400h	Bit	LS-5x1 v2, LS-5x2 v2
			29.04 Command to CB-control 4	Mask: 0800h	Bit	LS-5x1 v2, LS-5x2 v2
			29.05 Command to CB-control 5	Mask: 1000h	Bit	LS-5x1 v2, LS-5x2 v2

Modbus		Parameter ID	Description	Multiplier	Units	Model
Modicon start addr.	Start addr. (*1)					
			29.06 Command to CB-control 6	Mask: 2000h	Bit	LS-5x1 v2, LS-5x2 v2
			internal	Mask: 4000h	Bit	
			internal	Mask: 8000h	Bit	
450137	450136		Status of Device 17			
			Generator voltage and frequency ok	Mask: 0001h	Bit	LS-5x1 v2, LS-5x2 v2
			Busbar voltage and frequency ok	Mask: 0002h	Bit	LS-5x1 v2, LS-5x2 v2
			Mains voltage and frequency ok	Mask: 0004h	Bit	LS-5x1 v2, LS-5x2 v2
			4th system voltage and frequency ok	Mask: 0008h	Bit	LS-5x1 v2, LS-5x2 v2
			Busbar 1 dead busbar detection	Mask: 0010h	Bit	LS-5x1 v2, LS-5x2 v2
			Busbar 2 dead busbar detection	Mask: 0020h	Bit	LS-5x1 v2, LS-5x2 v2
			internal	Mask: 0040h	Bit	
			internal	Mask: 0080h	Bit	
			29.01 Command to CB-control 1	Mask: 0100h	Bit	LS-5x1 v2, LS-5x2 v2
			29.02 Command to CB-control 2	Mask: 0200h	Bit	LS-5x1 v2, LS-5x2 v2
			29.03 Command to CB-control 3	Mask: 0400h	Bit	LS-5x1 v2, LS-5x2 v2
			29.04 Command to CB-control 4	Mask: 0800h	Bit	LS-5x1 v2, LS-5x2 v2
			29.05 Command to CB-control 5	Mask: 1000h	Bit	LS-5x1 v2, LS-5x2 v2
			29.06 Command to CB-control 6	Mask: 2000h	Bit	LS-5x1 v2, LS-5x2 v2
			internal	Mask: 4000h	Bit	
			internal	Mask: 8000h	Bit	
450138	450137		Status of Device 18			
			Generator voltage and frequency ok	Mask: 0001h	Bit	LS-5x1 v2, LS-5x2 v2
			Busbar voltage and frequency ok	Mask: 0002h	Bit	LS-5x1 v2, LS-5x2 v2
			Mains voltage and frequency ok	Mask: 0004h	Bit	LS-5x1 v2, LS-5x2 v2
			4th system voltage and frequency ok	Mask: 0008h	Bit	LS-5x1 v2, LS-5x2 v2
			Busbar 1 dead busbar detection	Mask: 0010h	Bit	LS-5x1 v2, LS-5x2 v2
			Busbar 2 dead busbar detection	Mask: 0020h	Bit	LS-5x1 v2, LS-5x2 v2
			internal	Mask: 0040h	Bit	

Appendix

Data Protocols > Modbus > Data Protocol 5300 (Basic ...

Modbus		Parameter ID	Description	Multiplier	Units	Model
Mod- icon start addr.	Start addr. (*1)					
			internal	Mask: 0080h	Bit	
			29.01 Command to CB-control 1	Mask: 0100h	Bit	LS-5x1 v2, LS-5x2 v2
			29.02 Command to CB-control 2	Mask: 0200h	Bit	LS-5x1 v2, LS-5x2 v2
			29.03 Command to CB-control 3	Mask: 0400h	Bit	LS-5x1 v2, LS-5x2 v2
			29.04 Command to CB-control 4	Mask: 0800h	Bit	LS-5x1 v2, LS-5x2 v2
			29.05 Command to CB-control 5	Mask: 1000h	Bit	LS-5x1 v2, LS-5x2 v2
			29.06 Command to CB-control 6	Mask: 2000h	Bit	LS-5x1 v2, LS-5x2 v2
			internal	Mask: 4000h	Bit	
			internal	Mask: 8000h	Bit	
450139	450138		Status of Device 19			
			Generator voltage and frequency ok	Mask: 0001h	Bit	LS-5x1 v2, LS-5x2 v2
			Busbar voltage and frequency ok	Mask: 0002h	Bit	LS-5x1 v2, LS-5x2 v2
			Mains voltage and frequency ok	Mask: 0004h	Bit	LS-5x1 v2, LS-5x2 v2
			4th system voltage and frequency ok	Mask: 0008h	Bit	LS-5x1 v2, LS-5x2 v2
			Busbar 1 dead busbar detection	Mask: 0010h	Bit	LS-5x1 v2, LS-5x2 v2
			Busbar 2 dead busbar detection	Mask: 0020h	Bit	LS-5x1 v2, LS-5x2 v2
			internal	Mask: 0040h	Bit	
			internal	Mask: 0080h	Bit	
			29.01 Command to CB-control 1	Mask: 0100h	Bit	LS-5x1 v2, LS-5x2 v2
			29.02 Command to CB-control 2	Mask: 0200h	Bit	LS-5x1 v2, LS-5x2 v2
			29.03 Command to CB-control 3	Mask: 0400h	Bit	LS-5x1 v2, LS-5x2 v2
			29.04 Command to CB-control 4	Mask: 0800h	Bit	LS-5x1 v2, LS-5x2 v2
			29.05 Command to CB-control 5	Mask: 1000h	Bit	LS-5x1 v2, LS-5x2 v2
			29.06 Command to CB-control 6	Mask: 2000h	Bit	LS-5x1 v2, LS-5x2 v2
			internal	Mask: 4000h	Bit	
			internal	Mask: 8000h	Bit	
450140	450139		Status of Device 20			
			Generator voltage and frequency ok	Mask: 0001h	Bit	LS-5x1 v2, LS-5x2 v2

Modbus		Parameter ID	Description	Multiplier	Units	Model
Modicon start addr.	Start addr. (*1)					
			Busbar voltage and frequency ok	Mask: 0002h	Bit	LS-5x1 v2, LS-5x2 v2
			Mains voltage and frequency ok	Mask: 0004h	Bit	LS-5x1 v2, LS-5x2 v2
			4th system voltage and frequency ok	Mask: 0008h	Bit	LS-5x1 v2, LS-5x2 v2
			Busbar 1 dead busbar detection	Mask: 0010h	Bit	LS-5x1 v2, LS-5x2 v2
			Busbar 2 dead busbar detection	Mask: 0020h	Bit	LS-5x1 v2, LS-5x2 v2
			internal	Mask: 0040h	Bit	
			internal	Mask: 0080h	Bit	
			29.01 Command to CB-control 1	Mask: 0100h	Bit	LS-5x1 v2, LS-5x2 v2
			29.02 Command to CB-control 2	Mask: 0200h	Bit	LS-5x1 v2, LS-5x2 v2
			29.03 Command to CB-control 3	Mask: 0400h	Bit	LS-5x1 v2, LS-5x2 v2
			29.04 Command to CB-control 4	Mask: 0800h	Bit	LS-5x1 v2, LS-5x2 v2
			29.05 Command to CB-control 5	Mask: 1000h	Bit	LS-5x1 v2, LS-5x2 v2
			29.06 Command to CB-control 6	Mask: 2000h	Bit	LS-5x1 v2, LS-5x2 v2
			internal	Mask: 4000h	Bit	
			internal	Mask: 8000h	Bit	
450141	450140		Status of Device 21			
			Generator voltage and frequency ok	Mask: 0001h	Bit	LS-5x1 v2, LS-5x2 v2
			Busbar voltage and frequency ok	Mask: 0002h	Bit	LS-5x1 v2, LS-5x2 v2
			Mains voltage and frequency ok	Mask: 0004h	Bit	LS-5x1 v2, LS-5x2 v2
			4th system voltage and frequency ok	Mask: 0008h	Bit	LS-5x1 v2, LS-5x2 v2
			Busbar 1 dead busbar detection	Mask: 0010h	Bit	LS-5x1 v2, LS-5x2 v2
			Busbar 2 dead busbar detection	Mask: 0020h	Bit	LS-5x1 v2, LS-5x2 v2
			internal	Mask: 0040h	Bit	
			internal	Mask: 0080h	Bit	
			29.01 Command to CB-control 1	Mask: 0100h	Bit	LS-5x1 v2, LS-5x2 v2
			29.02 Command to CB-control 2	Mask: 0200h	Bit	LS-5x1 v2, LS-5x2 v2
			29.03 Command to CB-control 3	Mask: 0400h	Bit	LS-5x1 v2, LS-5x2 v2

Appendix

Data Protocols > Modbus > Data Protocol 5300 (Basic ...

Modbus		Parameter ID	Description	Multiplier	Units	Model
Modicon start addr.	Start addr. (*1)					
			29.04 Command to CB-control 4	Mask: 0800h	Bit	LS-5x1 v2, LS-5x2 v2
			29.05 Command to CB-control 5	Mask: 1000h	Bit	LS-5x1 v2, LS-5x2 v2
			29.06 Command to CB-control 6	Mask: 2000h	Bit	LS-5x1 v2, LS-5x2 v2
			internal	Mask: 4000h	Bit	
			internal	Mask: 8000h	Bit	
450142	450141		Status of Device 22			
			Generator voltage and frequency ok	Mask: 0001h	Bit	LS-5x1 v2, LS-5x2 v2
			Busbar voltage and frequency ok	Mask: 0002h	Bit	LS-5x1 v2, LS-5x2 v2
			Mains voltage and frequency ok	Mask: 0004h	Bit	LS-5x1 v2, LS-5x2 v2
			4th system voltage and frequency ok	Mask: 0008h	Bit	LS-5x1 v2, LS-5x2 v2
			Busbar 1 dead busbar detection	Mask: 0010h	Bit	LS-5x1 v2, LS-5x2 v2
			Busbar 2 dead busbar detection	Mask: 0020h	Bit	LS-5x1 v2, LS-5x2 v2
			internal	Mask: 0040h	Bit	
			internal	Mask: 0080h	Bit	
			29.01 Command to CB-control 1	Mask: 0100h	Bit	LS-5x1 v2, LS-5x2 v2
			29.02 Command to CB-control 2	Mask: 0200h	Bit	LS-5x1 v2, LS-5x2 v2
			29.03 Command to CB-control 3	Mask: 0400h	Bit	LS-5x1 v2, LS-5x2 v2
			29.04 Command to CB-control 4	Mask: 0800h	Bit	LS-5x1 v2, LS-5x2 v2
			29.05 Command to CB-control 5	Mask: 1000h	Bit	LS-5x1 v2, LS-5x2 v2
			29.06 Command to CB-control 6	Mask: 2000h	Bit	LS-5x1 v2, LS-5x2 v2
			internal	Mask: 4000h	Bit	
			internal	Mask: 8000h	Bit	
450143	450142		Status of Device 23			
			Generator voltage and frequency ok	Mask: 0001h	Bit	LS-5x1 v2, LS-5x2 v2
			Busbar voltage and frequency ok	Mask: 0002h	Bit	LS-5x1 v2, LS-5x2 v2
			Mains voltage and frequency ok	Mask: 0004h	Bit	LS-5x1 v2, LS-5x2 v2
			4th system voltage and frequency ok	Mask: 0008h	Bit	LS-5x1 v2, LS-5x2 v2
			Busbar 1 dead busbar detection	Mask: 0010h	Bit	LS-5x1 v2, LS-5x2 v2

Modbus		Parameter ID	Description	Multiplier	Units	Model
Modicon start addr.	Start addr. (*1)					
			Busbar 2 dead busbar detection	Mask: 0020h	Bit	LS-5x1 v2, LS-5x2 v2
			internal	Mask: 0040h	Bit	
			internal	Mask: 0080h	Bit	
			29.01 Command to CB-control 1	Mask: 0100h	Bit	LS-5x1 v2, LS-5x2 v2
			29.02 Command to CB-control 2	Mask: 0200h	Bit	LS-5x1 v2, LS-5x2 v2
			29.03 Command to CB-control 3	Mask: 0400h	Bit	LS-5x1 v2, LS-5x2 v2
			29.04 Command to CB-control 4	Mask: 0800h	Bit	LS-5x1 v2, LS-5x2 v2
			29.05 Command to CB-control 5	Mask: 1000h	Bit	LS-5x1 v2, LS-5x2 v2
			29.06 Command to CB-control 6	Mask: 2000h	Bit	LS-5x1 v2, LS-5x2 v2
			internal	Mask: 4000h	Bit	
			internal	Mask: 8000h	Bit	
450144	450143		Status of Device 24			
			Generator voltage and frequency ok	Mask: 0001h	Bit	LS-5x1 v2, LS-5x2 v2
			Busbar voltage and frequency ok	Mask: 0002h	Bit	LS-5x1 v2, LS-5x2 v2
			Mains voltage and frequency ok	Mask: 0004h	Bit	LS-5x1 v2, LS-5x2 v2
			4th system voltage and frequency ok	Mask: 0008h	Bit	LS-5x1 v2, LS-5x2 v2
			Busbar 1 dead busbar detection	Mask: 0010h	Bit	LS-5x1 v2, LS-5x2 v2
			Busbar 2 dead busbar detection	Mask: 0020h	Bit	LS-5x1 v2, LS-5x2 v2
			internal	Mask: 0040h	Bit	
			internal	Mask: 0080h	Bit	
			29.01 Command to CB-control 1	Mask: 0100h	Bit	LS-5x1 v2, LS-5x2 v2
			29.02 Command to CB-control 2	Mask: 0200h	Bit	LS-5x1 v2, LS-5x2 v2
			29.03 Command to CB-control 3	Mask: 0400h	Bit	LS-5x1 v2, LS-5x2 v2
			29.04 Command to CB-control 4	Mask: 0800h	Bit	LS-5x1 v2, LS-5x2 v2
			29.05 Command to CB-control 5	Mask: 1000h	Bit	LS-5x1 v2, LS-5x2 v2
			29.06 Command to CB-control 6	Mask: 2000h	Bit	LS-5x1 v2, LS-5x2 v2
			internal	Mask: 4000h	Bit	
			internal	Mask: 8000h	Bit	

Appendix

Data Protocols > Modbus > Data Protocol 5300 (Basic ...

Modbus		Parameter ID	Description	Multiplier	Units	Model
Mod- icon start addr.	Start addr. (*1)					
450145	450144		Status of Device 25			
			Generator voltage and frequency ok	Mask: 0001h	Bit	LS-5x1 v2, LS-5x2 v2
			Busbar voltage and frequency ok	Mask: 0002h	Bit	LS-5x1 v2, LS-5x2 v2
			Mains voltage and frequency ok	Mask: 0004h	Bit	LS-5x1 v2, LS-5x2 v2
			4th system voltage and frequency ok	Mask: 0008h	Bit	LS-5x1 v2, LS-5x2 v2
			Busbar 1 dead busbar detection	Mask: 0010h	Bit	LS-5x1 v2, LS-5x2 v2
			Busbar 2 dead busbar detection	Mask: 0020h	Bit	LS-5x1 v2, LS-5x2 v2
			internal	Mask: 0040h	Bit	
			internal	Mask: 0080h	Bit	
			29.01 Command to CB-control 1	Mask: 0100h	Bit	LS-5x1 v2, LS-5x2 v2
			29.02 Command to CB-control 2	Mask: 0200h	Bit	LS-5x1 v2, LS-5x2 v2
			29.03 Command to CB-control 3	Mask: 0400h	Bit	LS-5x1 v2, LS-5x2 v2
			29.04 Command to CB-control 4	Mask: 0800h	Bit	LS-5x1 v2, LS-5x2 v2
			29.05 Command to CB-control 5	Mask: 1000h	Bit	LS-5x1 v2, LS-5x2 v2
			29.06 Command to CB-control 6	Mask: 2000h	Bit	LS-5x1 v2, LS-5x2 v2
			internal	Mask: 4000h	Bit	
			internal	Mask: 8000h	Bit	
450146	450145		Status of Device 26			
			Generator voltage and frequency ok	Mask: 0001h	Bit	LS-5x1 v2, LS-5x2 v2
			Busbar voltage and frequency ok	Mask: 0002h	Bit	LS-5x1 v2, LS-5x2 v2
			Mains voltage and frequency ok	Mask: 0004h	Bit	LS-5x1 v2, LS-5x2 v2
			4th system voltage and frequency ok	Mask: 0008h	Bit	LS-5x1 v2, LS-5x2 v2
			Busbar 1 dead busbar detection	Mask: 0010h	Bit	LS-5x1 v2, LS-5x2 v2
			Busbar 2 dead busbar detection	Mask: 0020h	Bit	LS-5x1 v2, LS-5x2 v2
			internal	Mask: 0040h	Bit	
			internal	Mask: 0080h	Bit	
			29.01 Command to CB-control 1	Mask: 0100h	Bit	LS-5x1 v2, LS-5x2 v2
			29.02 Command to CB-control 2	Mask: 0200h	Bit	LS-5x1 v2, LS-5x2 v2

Modbus		Parameter ID	Description	Multiplier	Units	Model
Modicon start addr.	Start addr. (*1)					
			29.03 Command to CB-control 3	Mask: 0400h	Bit	LS-5x1 v2, LS-5x2 v2
			29.04 Command to CB-control 4	Mask: 0800h	Bit	LS-5x1 v2, LS-5x2 v2
			29.05 Command to CB-control 5	Mask: 1000h	Bit	LS-5x1 v2, LS-5x2 v2
			29.06 Command to CB-control 6	Mask: 2000h	Bit	LS-5x1 v2, LS-5x2 v2
			internal	Mask: 4000h	Bit	
			internal	Mask: 8000h	Bit	
450147	450146		Status of Device 27			
			Generator voltage and frequency ok	Mask: 0001h	Bit	LS-5x1 v2, LS-5x2 v2
			Busbar voltage and frequency ok	Mask: 0002h	Bit	LS-5x1 v2, LS-5x2 v2
			Mains voltage and frequency ok	Mask: 0004h	Bit	LS-5x1 v2, LS-5x2 v2
			4th system voltage and frequency ok	Mask: 0008h	Bit	LS-5x1 v2, LS-5x2 v2
			Busbar 1 dead busbar detection	Mask: 0010h	Bit	LS-5x1 v2, LS-5x2 v2
			Busbar 2 dead busbar detection	Mask: 0020h	Bit	LS-5x1 v2, LS-5x2 v2
			internal	Mask: 0040h	Bit	
			internal	Mask: 0080h	Bit	
			29.01 Command to CB-control 1	Mask: 0100h	Bit	LS-5x1 v2, LS-5x2 v2
			29.02 Command to CB-control 2	Mask: 0200h	Bit	LS-5x1 v2, LS-5x2 v2
			29.03 Command to CB-control 3	Mask: 0400h	Bit	LS-5x1 v2, LS-5x2 v2
			29.04 Command to CB-control 4	Mask: 0800h	Bit	LS-5x1 v2, LS-5x2 v2
			29.05 Command to CB-control 5	Mask: 1000h	Bit	LS-5x1 v2, LS-5x2 v2
			29.06 Command to CB-control 6	Mask: 2000h	Bit	LS-5x1 v2, LS-5x2 v2
			internal	Mask: 4000h	Bit	
			internal	Mask: 8000h	Bit	
450148	450147		Status of Device 28			
			Generator voltage and frequency ok	Mask: 0001h	Bit	LS-5x1 v2, LS-5x2 v2
			Busbar voltage and frequency ok	Mask: 0002h	Bit	LS-5x1 v2, LS-5x2 v2
			Mains voltage and frequency ok	Mask: 0004h	Bit	LS-5x1 v2, LS-5x2 v2
			4th system voltage and frequency ok	Mask: 0008h	Bit	LS-5x1 v2, LS-5x2 v2

Appendix

Data Protocols > Modbus > Data Protocol 5300 (Basic ...

Modbus		Parameter ID	Description	Multiplier	Units	Model
Mod- icon start addr.	Start addr. (*1)					
			Busbar 1 dead busbar detection	Mask: 0010h	Bit	LS-5x1 v2, LS-5x2 v2
			Busbar 2 dead busbar detection	Mask: 0020h	Bit	LS-5x1 v2, LS-5x2 v2
			internal	Mask: 0040h	Bit	
			internal	Mask: 0080h	Bit	
			29.01 Command to CB-control 1	Mask: 0100h	Bit	LS-5x1 v2, LS-5x2 v2
			29.02 Command to CB-control 2	Mask: 0200h	Bit	LS-5x1 v2, LS-5x2 v2
			29.03 Command to CB-control 3	Mask: 0400h	Bit	LS-5x1 v2, LS-5x2 v2
			29.04 Command to CB-control 4	Mask: 0800h	Bit	LS-5x1 v2, LS-5x2 v2
			29.05 Command to CB-control 5	Mask: 1000h	Bit	LS-5x1 v2, LS-5x2 v2
			29.06 Command to CB-control 6	Mask: 2000h	Bit	LS-5x1 v2, LS-5x2 v2
			internal	Mask: 4000h	Bit	
			internal	Mask: 8000h	Bit	
450149	450148		Status of Device 29			
			Generator voltage and frequency ok	Mask: 0001h	Bit	LS-5x1 v2, LS-5x2 v2
			Busbar voltage and frequency ok	Mask: 0002h	Bit	LS-5x1 v2, LS-5x2 v2
			Mains voltage and frequency ok	Mask: 0004h	Bit	LS-5x1 v2, LS-5x2 v2
			4th system voltage and frequency ok	Mask: 0008h	Bit	LS-5x1 v2, LS-5x2 v2
			Busbar 1 dead busbar detection	Mask: 0010h	Bit	LS-5x1 v2, LS-5x2 v2
			Busbar 2 dead busbar detection	Mask: 0020h	Bit	LS-5x1 v2, LS-5x2 v2
			internal	Mask: 0040h	Bit	
			internal	Mask: 0080h	Bit	
			29.01 Command to CB-control 1	Mask: 0100h	Bit	LS-5x1 v2, LS-5x2 v2
			29.02 Command to CB-control 2	Mask: 0200h	Bit	LS-5x1 v2, LS-5x2 v2
			29.03 Command to CB-control 3	Mask: 0400h	Bit	LS-5x1 v2, LS-5x2 v2
			29.04 Command to CB-control 4	Mask: 0800h	Bit	LS-5x1 v2, LS-5x2 v2
			29.05 Command to CB-control 5	Mask: 1000h	Bit	LS-5x1 v2, LS-5x2 v2
			29.06 Command to CB-control 6	Mask: 2000h	Bit	LS-5x1 v2, LS-5x2 v2
			internal	Mask: 4000h	Bit	

Modbus		Parameter ID	Description	Multiplier	Units	Model
Modicon start addr.	Start addr. (*1)					
			internal	Mask: 8000h	Bit	
450150	450149		Status of Device 30			
			Generator voltage and frequency ok	Mask: 0001h	Bit	LS-5x1 v2, LS-5x2 v2
			Busbar voltage and frequency ok	Mask: 0002h	Bit	LS-5x1 v2, LS-5x2 v2
			Mains voltage and frequency ok	Mask: 0004h	Bit	LS-5x1 v2, LS-5x2 v2
			4th system voltage and frequency ok	Mask: 0008h	Bit	LS-5x1 v2, LS-5x2 v2
			Busbar 1 dead busbar detection	Mask: 0010h	Bit	LS-5x1 v2, LS-5x2 v2
			Busbar 2 dead busbar detection	Mask: 0020h	Bit	LS-5x1 v2, LS-5x2 v2
			internal	Mask: 0040h	Bit	
			internal	Mask: 0080h	Bit	
			29.01 Command to CB-control 1	Mask: 0100h	Bit	LS-5x1 v2, LS-5x2 v2
			29.02 Command to CB-control 2	Mask: 0200h	Bit	LS-5x1 v2, LS-5x2 v2
			29.03 Command to CB-control 3	Mask: 0400h	Bit	LS-5x1 v2, LS-5x2 v2
			29.04 Command to CB-control 4	Mask: 0800h	Bit	LS-5x1 v2, LS-5x2 v2
			29.05 Command to CB-control 5	Mask: 1000h	Bit	LS-5x1 v2, LS-5x2 v2
			29.06 Command to CB-control 6	Mask: 2000h	Bit	LS-5x1 v2, LS-5x2 v2
			internal	Mask: 4000h	Bit	
	internal	Mask: 8000h	Bit			
450151	450150		Status of Device 31			
			Generator voltage and frequency ok	Mask: 0001h	Bit	LS-5x1 v2, LS-5x2 v2
			Busbar voltage and frequency ok	Mask: 0002h	Bit	LS-5x1 v2, LS-5x2 v2
			Mains voltage and frequency ok	Mask: 0004h	Bit	LS-5x1 v2, LS-5x2 v2
			4th system voltage and frequency ok	Mask: 0008h	Bit	LS-5x1 v2, LS-5x2 v2
			Busbar 1 dead busbar detection	Mask: 0010h	Bit	LS-5x1 v2, LS-5x2 v2
			Busbar 2 dead busbar detection	Mask: 0020h	Bit	LS-5x1 v2, LS-5x2 v2
			internal	Mask: 0040h	Bit	
			internal	Mask: 0080h	Bit	
			29.01 Command to CB-control 1	Mask: 0100h	Bit	LS-5x1 v2, LS-5x2 v2

Appendix

Data Protocols > Modbus > Data Protocol 5300 (Basic ...

Modbus		Parameter ID	Description	Multiplier	Units	Model
Mod- icon start addr.	Start addr. (*1)					
			29.02 Command to CB-control 2	Mask: 0200h	Bit	LS-5x1 v2, LS-5x2 v2
			29.03 Command to CB-control 3	Mask: 0400h	Bit	LS-5x1 v2, LS-5x2 v2
			29.04 Command to CB-control 4	Mask: 0800h	Bit	LS-5x1 v2, LS-5x2 v2
			29.05 Command to CB-control 5	Mask: 1000h	Bit	LS-5x1 v2, LS-5x2 v2
			29.06 Command to CB-control 6	Mask: 2000h	Bit	LS-5x1 v2, LS-5x2 v2
			internal	Mask: 4000h	Bit	
			internal	Mask: 8000h	Bit	
450152	450151		Status of Device 32			
			Generator voltage and frequency ok	Mask: 0001h	Bit	LS-5x1 v2, LS-5x2 v2
			Busbar voltage and frequency ok	Mask: 0002h	Bit	LS-5x1 v2, LS-5x2 v2
			Mains voltage and frequency ok	Mask: 0004h	Bit	LS-5x1 v2, LS-5x2 v2
			4th system voltage and frequency ok	Mask: 0008h	Bit	LS-5x1 v2, LS-5x2 v2
			Busbar 1 dead busbar detection	Mask: 0010h	Bit	LS-5x1 v2, LS-5x2 v2
			Busbar 2 dead busbar detection	Mask: 0020h	Bit	LS-5x1 v2, LS-5x2 v2
			internal	Mask: 0040h	Bit	
			internal	Mask: 0080h	Bit	
			29.01 Command to CB-control 1	Mask: 0100h	Bit	LS-5x1 v2, LS-5x2 v2
			29.02 Command to CB-control 2	Mask: 0200h	Bit	LS-5x1 v2, LS-5x2 v2
			29.03 Command to CB-control 3	Mask: 0400h	Bit	LS-5x1 v2, LS-5x2 v2
			29.04 Command to CB-control 4	Mask: 0800h	Bit	LS-5x1 v2, LS-5x2 v2
			29.05 Command to CB-control 5	Mask: 1000h	Bit	LS-5x1 v2, LS-5x2 v2
			29.06 Command to CB-control 6	Mask: 2000h	Bit	LS-5x1 v2, LS-5x2 v2
			internal	Mask: 4000h	Bit	
			internal	Mask: 8000h	Bit	
450153	450152		reserved			
450154	450153		reserved			
450155	450154		reserved			
450156	450155		reserved			
450157	450156		reserved			

Modbus		Parameter ID	Description	Multiplier	Units	Model
Mod- icon start addr.	Start addr. (*1)					
450158	450157		reserved			
450159	450158		reserved			
450160	450159		reserved			
450161	450160		reserved			
450162	450161		reserved			
450163	450162		reserved			
450164	450163		reserved			
450165	450164		reserved			
450166	450165		reserved			
450167	450166		reserved			
450168	450167		reserved			
450169	450168		reserved			
450170	450169		reserved			
450171	450170		reserved			
450172	450171		reserved			
450173	450172		reserved			
450174	450173		reserved			
450175	450174		reserved			
450176	450175		reserved			
450177	450176		reserved			
450178	450177		reserved			
450179	450178		reserved			
450180	450179		reserved			
450181	450180		reserved			
450182	450181		reserved			
450183	450182		reserved			
450184	450183		reserved			
AC System A (Long - 32 bits)						
450185	450184	135	Total system A active power	1	W	LS-5x1 v2, LS-5x2 v2
450187	450186	136	Total system A reactive power	1	var	LS-5x1 v2, LS-5x2 v2
450189	450188	137	Total system A apparent power	1	VA	LS-5x1 v2, LS-5x2 v2
450191	450190	170	Av. system A wye-voltage	0.1	V	LS-5x1 v2, LS-5x2 v2
450193	450192	171	Av. system A delta-voltage	0.1	V	LS-5x1 v2, LS-5x2 v2

Appendix

Data Protocols > Modbus > Data Protocol 5300 (Basic ...

Modbus		Parameter ID	Description	Multiplier	Units	Model
Mod- icon start addr.	Start addr. (*1)					
450195	450194	185	Av. system A current	0.001	A	LS-5x1 v2, LS-5x2 v2
450197	450196	111	System A current 1	0.001	A	LS-5x1 v2, LS-5x2 v2
450199	450198	112	System A current 2	0.001	A	LS-5x1 v2, LS-5x2 v2
450201	450200	113	System A current 3	0.001	A	LS-5x1 v2, LS-5x2 v2
450203	450202	108	System A voltage L1-L2	0.1	V	LS-5x1 v2, LS-5x2 v2
450205	450204	109	System A voltage L2-L3	0.1	V	LS-5x1 v2, LS-5x2 v2
450207	450206	110	System A voltage L3-L1	0.1	V	LS-5x1 v2, LS-5x2 v2
450209	450208	114	System A voltage L1-N	0.1	V	LS-5x1 v2, LS-5x2 v2
450211	450210	115	System A voltage L2-N	0.1	V	LS-5x1 v2, LS-5x2 v2
450213	450212	116	System A voltage L3-N	0.1	V	LS-5x1 v2, LS-5x2 v2
450215	450214	125	System A active power L1-N	1	W	LS-5x1 v2, LS-5x2 v2
450217	450216	126	System A active power L2-N	1	W	LS-5x1 v2, LS-5x2 v2
450219	450218	127	System A active power L3-N	1	W	LS-5x1 v2, LS-5x2 v2
450221	450220	2520	System A positive active energy	0.01	MWh	LS-5x1 v2, LS-5x2 v2
450223	450222	135	System A total active power	1	W	LS-5x1 v2, LS-5x2 v2
450225	450224		reserved			
450227	450226		reserved			
450229	450228		reserved			
AC System B (Long - 32 bits)						
450231	450230	338	System B total active power AC measurement	1	W	LS-5x2 v2
450233	450232	150	Total system B reactive power	1	var	LS-5x2 v2
450235	450234	173	Av. system B wye-voltage	0.1	V	LS-5x1 v2, LS-5x2 v2
450237	450236	174	Av. system B delta-voltage	0.1	V	LS-5x1 v2, LS-5x2 v2
450239	450238	207	Av. system B current	0.001	A	LS-5x2 v2
450241	450240	134	System B current L1	0.001	A	LS-5x2 v2
450243	450242	118	System B voltage L1-L2	0.1	V	LS-5x1 v2, LS-5x2 v2
450245	450244	119	System B voltage L2-L3	0.1	V	LS-5x1 v2, LS-5x2 v2
450247	450246	120	System B voltage L3-L1	0.1	V	LS-5x1 v2, LS-5x2 v2

Modbus		Parameter ID	Description	Multiplier	Units	Model
Mod- icon start addr.	Start addr. (*1)					
450249	450248	121	System B voltage L1-N	0.1	V	LS-5x1 v2, LS-5x2 v2
450251	450250	122	System B voltage L2-N	0.1	V	LS-5x1 v2, LS-5x2 v2
450253	450252	123	System B voltage L3-N	0.1	V	LS-5x1 v2, LS-5x2 v2
450255	450254	140	System B total active power	1	W	LS-5x2 v2
450257	450256		reserved			
AC System Values (Long - 32 bits)						
450259	450258		reserved			
450261	450260		reserved			
450263	450262		reserved			
450265	450264		reserved			
450267	450266		reserved			
450269	450268		reserved			

9.2.3 Additional Data Identifier

9.2.3.1 Transmit Data

Remote control word 3



Object 21F9h (Parameter 505)

This object is required for remote control. These remote control bits can be used by a PLC to send control signals via SDO or PDO, which can then be used as command variables in the LogicsManager to control the easYgen. The data type is UNSIGNED16.

Bit 15 = 1 (ID 541)	Remote control bit 16 (command variable 04.59)
Bit 14 = 1 (ID 542)	Remote control bit 15 (command variable 04.58)
Bit 13 = 1 (ID 543)	Remote control bit 14 (command variable 04.57)
Bit 12 = 1 (ID 544)	Remote control bit 13 (command variable 04.56)
Bit 11 = 1 (ID 545)	Remote control bit 12 (command variable 04.55)
Bit 10 = 1 (ID 546)	Remote control bit 11 (command variable 04.54)
Bit 9 = 1 (ID 547)	Remote control bit 10 (command variable 04.53)
Bit 8 = 1 (ID 548)	Remote control bit 9 (command variable 04.52)
Bit 7 = 1 (ID 549)	Remote control bit 8 (command variable 04.51)
Bit 6 = 1 (ID 550)	Remote control bit 7 (command variable 04.50)
Bit 5 = 1 (ID 551)	Remote control bit 6 (command variable 04.49)
Bit 4 = 1 (ID 552)	Remote control bit 5 (command variable 04.48)

Bit 3 = 1 (ID 553)	Remote control bit 4 (command variable 04.47)
Bit 2 = 1 (ID 554)	Remote control bit 3 (command variable 04.46)
Bit 1 = 1 (ID 555)	Remote control bit 2 (command variable 04.45)
Bit 0 = 1 (ID 556)	Remote control bit 1 (command variable 04.44)

9.3 LogicsManager Reference

9.3.1 LogicsManager Overview

The LogicsManager is used to customize the sequence of events in the control unit such as the start command of the engine or the operation of control unit relay outputs. For example, the start routine may be programmed so that it requires the closing of a discrete input or a preset time of day.

Depending on the application mode of the unit, the number of available relays that may be programmed with the LogicsManager will vary.

Two independent time delays are provided for the configured action to take place and be reset.



Please do not use the output of an equation as input at the same time. Such a configuration could decrease the performance of the interfaces.

Structure and description of the LogicsManager

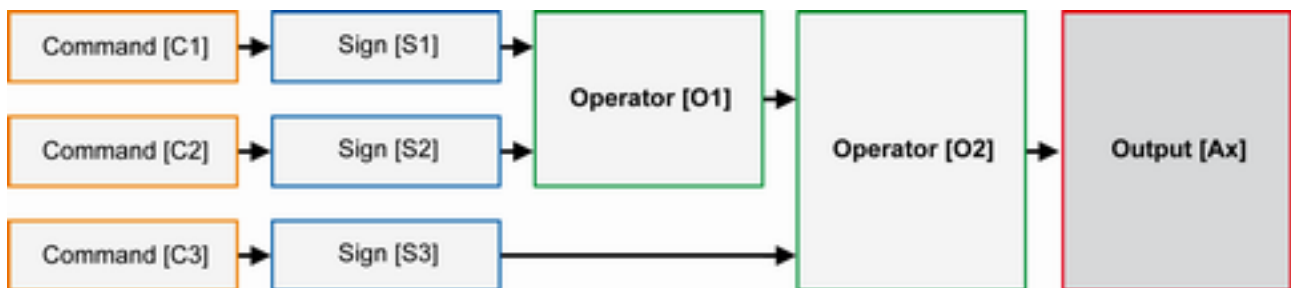

Fig. 171: LogicsManager - function overview

- **Command (variable)**
 A list of parameters and functions is provided for the command inputs.
 Examples of the parameters that may be configured into these commands are generator undervoltage thresholds 1 and 2, start fail, and cool down.
 These command variables are used to control the output function or relay.
 Refer to [Chapter 9.3.4 "Logical Command Variables"](#) on page 360 for a complete list of all command variables.
- **Sign**
 The sign field can be used to invert the state of the command or to fix its output to a logical true or false if the command is not needed. Setting the sign to the NOT state changes the output of the command variable from true to false or vice versa.

- **Operator**

A logical device such as AND or OR.

- **(Logical) output**

The action or control sequence that occurs when all parameters set into the LogicsManager are met.

For a complete list of all logical outputs refer to [Chapter 9.3.3 "Logical Outputs" on page 357](#).





[Sx] - Sign {x}		
	Value {[Cx]}	The value [Cx] is passed 1:1.
	NOT Value {[Cx]}	The opposite of the value [Cx] is passed.
	0 [False; always "0"]	The value [Cx] is ignored and this logic path will always be FALSE.
	1 [True; always "1"]	The value [Cx] is ignored and this logic path will always be TRUE.

Table 46: Signs

[Ox] - Operator {x}	
AND	Logical AND
NAND	Logical negated AND
OR	Logical OR
NOR	Logical negated OR
XOR	Exclusive OR
NXOR	Exclusive negated OR

Table 47: Operators



For the various display formats of the corresponding logical symbols refer to [Chapter 9.3.2 "Logical Symbols" on page 356](#).

Configuration of the command chain

Using the values specified in the above table, the chain of commands of the LogicsManager (for example: operating the relays, setting the flags, specification of the automatic functions) is configured as follows:

```
[Ax] = ( ( [C1] & [S1] ) & [O1] & ( [C2] & [S2] ) ) & [O2] & ( [C3] & [S3] )
```

Programming example for the LogicsManager



- Relay [R2] shall energize, whenever "Discrete input [D1 02]" is energized "AND" the control does "NOT" have a fault that is "Alarm class C" "AND" does "NOT" have a fault that is "Alarm class D"

Fig. 172: Programming example (ToolKit)

9.3.2 Logical Symbols

The following symbols are used for the graphical programming of the LogicsManager. The LS-5 displays symbols according to the DIN 40 700 standard by default.

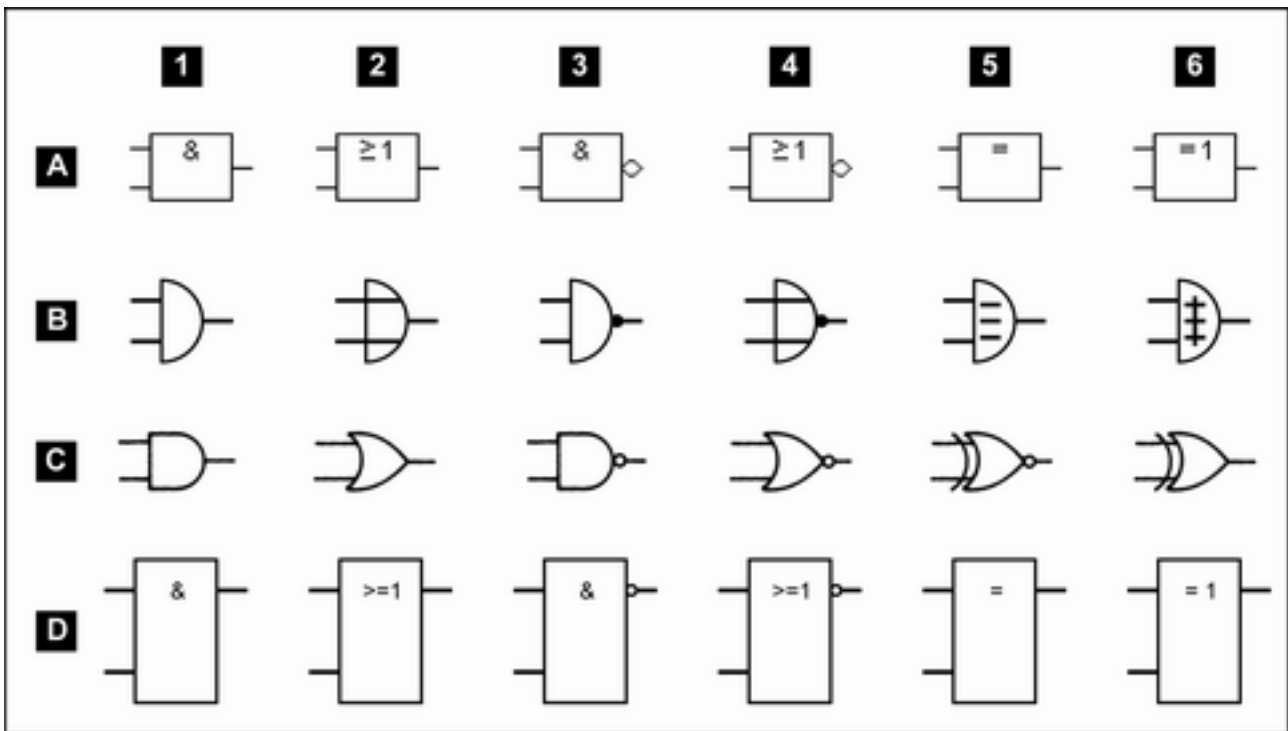

Fig. 173: Logical symbols

Row	... according to standard:
A	IEC
B	LS-5 (default: DIN 40 700)
C	ASA US MIL
D	IEC617-12

Meaning of the columns					
1	2	3	4	5	6
AND	OR	NAND	NOR	NXOR	XOR

AND				OR				NAND				NOR				NXOR				XOR						
x1	x2	y		x1	x2	y		x1	x2	y		x1	x2	y		x1	x2	y		x1	x2	y				
0	0	0		0	0	0		0	0	1		0	0	1		0	0	1		0	0	0		0	0	0
0	1	0		0	1	1		0	1	1		0	1	0		0	1	0		0	1	1		0	1	1
1	0	0		1	0	1		1	0	1		1	0	0		1	0	0		1	0	0		1	0	1
1	1	1		1	1	1		1	1	0		1	1	0		1	1	1		1	1	0		1	1	0

Table 48: Truth table

9.3.3 Logical Outputs

The logical outputs or combinations may be grouped into three categories:

- Internal logical flags
- Internal functions
- Relay outputs



The numbers of the logical outputs in the third column may again be used as input variable for other outputs in the LogicsManager.

Internal flags

16 internal logical flags may be programmed to activate/deactivate functions. This permits more than 3 commands to be included in a logical function. They may be used like "auxiliary flags".

Name	Function	Number
Flag 1	Internal flag 1	00.01
Flag 2	Internal flag 2	00.02
Flag 3	Internal flag 3	00.03
Flag 4	Internal flag 4	00.04
Flag 5	Internal flag 5	00.05
Flag 6	Internal flag 6	00.06
Flag 7	Internal flag 7	00.07
Flag 8	Internal flag 8	00.08
Flag 9	Internal flag 9	00.30
Flag 10	Internal flag 10	00.31
Flag 11	Internal flag 11	00.32
Flag 12	Internal flag 12	00.33
Flag 13	Internal flag 13	00.34

Name	Function	Number
Flag 14	Internal flag 14	00.35
Flag 15	Internal flag 15	00.36
Flag 16	Internal flag 16	00.37

LS-5 flags

5 internal logical LS-5 flags may be programmed to activate/deactivate functions. This permits more than 3 commands to be included in a logical function. They may be used like "auxiliary flags".

These flags are transmitted on the CAN bus. The flags of all LS-5 are received (as 26.01 to 27.80) by the LS-5 and the easYgen. They can be used as inputs for the LogicsManager.

Name	Function	Number
Flag 1 LS5	LS5 flag 1	24.41
Flag 2 LS5	LS5 flag 2	24.42
Flag 3 LS5	LS5 flag 3	24.43
Flag 4 LS5	LS5 flag 4	24.44
Flag 5 LS5	LS5 flag 5	24.45

Internal functions

The following logical functions may be used to activate/deactivate functions.

Name	Function	Number
External acknowledge	The alarm acknowledgement is performed from an external source (parameter 12490 ↗ p. 118)	00.15
Operation mode AUTO	Activation of the AUTOMATIC operating mode (parameter 12510 ↗ p. 132)	00.16
Operation mode MAN	Activation of the MANUAL operating mode (parameter 12520 ↗ p. 132)	00.17
Synchronization mode CHECK	Used for checking a synchronizer prior to commissioning. The system actively synchronizes generator(s) by issuing speed and voltage bias commands, but does not issue a breaker closure command. (parameter 5728 ↗ p. 125)	00.38
Synchronization mode PERMISSIVE	The system acts in a synch check mode. The system will not issue speed or voltage bias commands to achieve synchronization, but if synchronization conditions are matched (frequency, phase, voltage and phase angle), the control will issue a breaker close command. (parameter 5728 ↗ p. 125)	00.39
Synchronization mode RUN	Normal operating mode. The system actively synchronizes and issues breaker closure commands. (parameter 5728 ↗ p. 125)	00.40
Lock keypad	Activation of lock keypad (parameter 12978 ↗ p. 73)	00.95
Enable System A decoupling	(parameter 12942 ↗ p. 82)	24.31
Open CBA unload	(parameter 12943 ↗ p. 122)	24.32
Open CBA immediately	(parameter 12944 ↗ p. 122)	24.33
Enable to close CBA	(parameter 12945 ↗ p. 122)	24.34
Variable system is A	(parameter 12949 ↗ p. 131)	24.38
Isolation switch open	(parameter 12950 ↗ p. 120)	24.39
Lock Monitoring	(parameter 12959 ↗ p. 118)	24.40

Name	Function	Number
Open CBA in MAN	(parameter 12957 ↗ p. 121)	24.46
Close CBA in MAN	(parameter 12958 ↗ p. 122)	24.47

Relay outputs

All relays may be controlled directly by the LogicsManager depending on the respective application mode.

Name	Terminal	Function	Number
Relay 1 [R1] (Ready for operation OFF)	30/31	LogicsManager; combined with 'Ready for operation OFF' If this logical output becomes true, the relay output 1 will be activated	00.41
Relay 2 [R2]	32/33	LogicsManager; pre-assigned with 'Centralized alarm (horn)' If this logical output becomes true, the relay output 2 will be activated	00.42
Relay 3 [R3]	34/35	LogicsManager; pre-assigned with 'System B not OK' If this logical output becomes true, the relay output 3 will be activated	00.43
Relay 4 [R4]	36/37	LogicsManager; pre-assigned with 'System A not OK' If this logical output becomes true, the relay output 4 will be activated	00.44
Relay 5 [R5]	38/39/40	Fixed to 'Open CBA'	---
Relay 6 [R6]	41/42	Fixed to 'Close CBA' if CBA is controlled by 2 relays (parameter 8800 ↗ p. 121) otherwise LogicsManager pre-assigned with 'All alarm classes' If this logical output becomes true, the relay output 6 will be activated	00.46

LEDs

Note The LEDs are implemented only in devices without display.

All LEDs may be controlled directly by the LogicsManager.

Name	Default value	Function	Number
LED 1	System A in range (02.11)	See LogicsManager "LED 1" (parameter 12962 ↗ p. 148) The default value indicates that voltage and frequency of System A are in range.	24.51
LED 2	System B in range (02.05)	See LogicsManager "LED 2" (parameter 12963 ↗ p. 148) The default value indicates that voltage and frequency of System B are in range.	24.52
LED 3	Breaker is closed (04.07)	See LogicsManager "LED 3" (parameter 12964 ↗ p. 148) The default value indicates that the breaker is closed.	24.53
LED 4	Synchronization is active (04.21)	See LogicsManager "LED 4" (parameter 12965 ↗ p. 148) The default value indicates that the synchronization is active.	24.54

Name	Default value	Function	Number
LED 5	Breaker close command (04.23)	See LogicsManager "LED 5" (parameter 12966 ↗ p. 148) The default value indicates that the breaker close command is active.	24.55
LED 6	Breaker open failure (08.08)	See LogicsManager "LED 6" (parameter 12967 ↗ p. 148) The default value indicates that a breaker open failure is active.	24.56
LED 7	Breaker close failure (08.07)	See LogicsManager "LED 7" (parameter 12968 ↗ p. 148) The default value indicates that a breaker close failure is active.	24.57
LED 8	Communication failure (08.17 Missing LS-5)	See LogicsManager "LED 8" (parameter 12969 ↗ p. 148). The default value indicates that the multi-unit missing members monitoring function (parameter 4060 ↗ p. 117) has tripped.	24.58

9.3.4 Logical Command Variables

The logical command variables are grouped into different categories

- Group 00: Flags condition 1
- Group 01: Alarm system
- Group 02: Systems condition
- Group 04: Applications condition
- Group 05: Device related alarms
- Group 06: System B (SyB.) related alarms
- Group 07: System A (SyA.) related alarms
- Group 08: System related alarms
- Group 09: Discrete inputs
- Group 11: Clock and timer
- Group 13: Discrete outputs
- Group 17: Alarm system 2
- Group 24: Flags condition 2
- Group 26(/1-2): Flags of LS-5 device 33 to 48
- Group 27(/1-2): Flags of LS-5 device 49 to 64
- Group 28: LS-5 system conditions
- Group 29(/1-3): Commands of easYgen device 1 to 16
- Group 30(/1-3): Commands of easYgen device 17 to 32

9.3.4.1 Group 00: Flags Condition 1

- Flags condition 1
- Logic command variables 00.01-00.95

Internal Flags are the result of the output of the logic ladders from Flag 1 to 16. Flags are internal logic that can be sent to other flags or Command variables.

'LM' means that these logical command variables are the result of a LogicsManager condition.

No.	Name	Function	Note
00.01	LM Flag 1	Internal flag 1	Internal calculation; refer to “ Internal flags” on page 357
00.02	LM Flag 2	Internal flag 2	Internal calculation; refer to “ Internal flags” on page 357
00.03	LM Flag 3	Internal flag 3	Internal calculation; refer to “ Internal flags” on page 357
00.04	LM Flag 4	Internal flag 4	Internal calculation; refer to “ Internal flags” on page 357
00.05	LM Flag 5	Internal flag 5	Internal calculation; refer to “ Internal flags” on page 357
00.06	LM Flag 6	Internal flag 6	Internal calculation; refer to “ Internal flags” on page 357
00.07	LM Flag 7	Internal flag 7	Internal calculation; refer to “ Internal flags” on page 357
00.08	LM Flag 8	Internal flag 8	Internal calculation; refer to “ Internal flags” on page 357
00.15	LM Ext. acknowl.	The alarm acknowledgement is performed from an external source	
00.16	LM Operat. mode AUTO	Activation of the AUTOMATIC operating mode	
00.17	LM Operat. mode MAN	Activation of the MANUAL operating mode	
00.30	LM Flag 9	Internal flag 9	Internal calculation; refer to “ Internal flags” on page 357
00.31	LM Flag 10	Internal flag 10	Internal calculation; refer to “ Internal flags” on page 357
00.32	LM Flag 11	Internal flag 11	Internal calculation; refer to “ Internal flags” on page 357
00.33	LM Flag 12	Internal flag 12	Internal calculation; refer to “ Internal flags” on page 357
00.34	LM Flag 13	Internal flag 13	Internal calculation; refer to “ Internal flags” on page 357
00.35	LM Flag 14	Internal flag 14	Internal calculation; refer to “ Internal flags” on page 357
00.36	LM Flag 15	Internal flag 15	Internal calculation; refer to “ Internal flags” on page 357
00.37	LM Flag 16	Internal flag 16	Internal calculation; refer to “ Internal flags” on page 357
00.38	LM Syn. mode CHECK	Synchronisation mode check is active	
00.39	LM Syn. mode PERM.	Synchronisation mode permissive is active	
00.40	LM Syn. mode RUN	Synchronisation mode run is active	
00.41	LM Relay 1 (Ready for op.OFF)		TRUE, if the LogicsManager condition driving this relay is fulfilled
00.42	LM Relay 2		
00.43	LM Relay 3		
00.44	LM Relay 4		

No.	Name	Function	Note
00.45	Reserved		
00.46	LM Relay 6		
00.95	LM Lock keypad	Lock keypad is active	

9.3.4.2 Group 01: Alarm System

- Alarm system
- Logic command variables 01.01-01.12

Alarm classes may be configured as command variables for all logical outputs in the LogicsManager. Refer to [Chapter 9.4.1 “Alarm Classes” on page 384](#) for a description of the alarm classes.

No.	Name / Function	Note
01.01	Alarm class A	TRUE as long as an alarm of this alarm class is active or latched (triggered)
01.02	Alarm class B	TRUE as long as an alarm of this alarm class is active or latched (triggered)
01.03	Alarm class C	TRUE as long as an alarm of this alarm class is active or latched (triggered)
01.04	Alarm class D	TRUE as long as an alarm of this alarm class is active or latched (triggered)
01.05	Alarm class E	TRUE as long as an alarm of this alarm class is active or latched (triggered)
01.06	Alarm class F	TRUE as long as an alarm of this alarm class is active or latched (triggered)
01.07	All alarm classes	TRUE as long as at least one alarm of the alarm classes A/B/C/D/E/F is active or latched (triggered)
01.08	Warning alarm	TRUE as long as at least one alarm of the alarm classes A/B is active or latched (triggered)
01.09	Shutdown alarm	TRUE as long as at least one alarm of the alarm classes C/D/E/F is active or latched (triggered)
01.10	Centralized alarm	TRUE as long as at least one alarm of the alarm classes B/C/D/E/F is active or latched (triggered)
01.11	New alarm triggered	TRUE if any alarm has been triggered until it is acknowledged
01.12	Horn	True if a new alarm is triggered and time (parameter 1756 p. 118) for horn reset has not exceeded.

9.3.4.3 Group 02: Systems Condition

- Systems condition
- Logic command variables 02.03-02.30

The status of the system may be used as command variable in a logical output to set parameters for customized operations.

No.	Name	Function	Note
02.03	SyB. voltage ok	SyB. voltage within operating range	TRUE as long as the SyB. voltage is within the operating range
02.04	SyB. freq. ok	SyB. frequency within operating range	TRUE as long as the SyB. frequency is within the operating range
02.05	SyB. volt./ freq. ok	SyB. voltage and frequency within operating ranges	TRUE as long as the SyB. voltage and frequency are within the operating ranges (02.03. and 02.04 are TRUE)
02.09	SyA. voltage ok	SyA. voltage within operating range	TRUE as long as the SyA. voltage is within the operating range
02.10	SyA. freq. ok	SyA. frequency within operating range	TRUE as long as the SyA. frequency is within the operating range
02.11	SyA. volt. / freq. ok	SyA. voltage and frequency within operating ranges	TRUE as long as the SyA. voltage and frequency are within the operating ranges (02.09. and 02.10 are TRUE)
02.12	SyA. rot. CCW	SyA. voltage: rotating direction CCW	TRUE as long as the respective rotation field is detected in case of a three-phase voltage measurement at the respective measuring location
02.13	SyA. rot. CW	SyA. voltage: rotating direction CW	
02.14	SyB. rot. CCW	SyB. voltage: rotating direction CCW	
02.15	SyB. rot. CW	SyB. voltage: rotating direction CW	
02.23	System A is dead	System A is dead	TRUE as long as system A voltage is below the level defined by parameter 5820 ↗ p. 120.
02.24	System B is dead	System B is dead	TRUE as long as system B voltage is below the level defined by parameter 5820 ↗ p. 120.
02.25	Gen. is mains par.	Indicates generator is in mains parallel operation	TRUE if system A (B) is mains connected and system B (A) is variable and CBA is closed and at least one GCB (easYgen) at a relevant segment is closed. (It can be used to enable mains decoupling.)
02.28	Sync. check relay	Indicates phase matching or Dead Bus conditions met	<p>TRUE if synchronization conditions are TRUE defined by parameters 5711 ↗ p. 123, 5712 ↗ p. 123, 5710 ↗ p. 123, 8825 ↗ p. 125, 8824 ↗ p. 125, 5712 ↗ p. 123, 5714 ↗ p. 124 and 5717 ↗ p. 124</p> <p>OR if Dead Bus conditions are TRUE defined by parameters 8801 ↗ p. 120, 5820 ↗ p. 120, 8805 ↗ p. 120, 8802 ↗ p. 120, 8803 ↗ p. 121 and 8804 ↗ p. 121.</p> <p>Warning No dead bus interlocking.</p>
02.29	Sync. condition	Indicates phase matching conditions met	TRUE if synchronization conditions are TRUE defined by parameters 5711 ↗ p. 123, 5712 ↗ p. 123, 5710 ↗ p. 123, 8825 ↗ p. 125, 8824 ↗ p. 125, 5712 ↗ p. 123, 5714 ↗ p. 124 and 5717 ↗ p. 124.

No.	Name	Function	Note
02.30	Dead bus cl. cond.	Indicates Dead Bus conditions met	TRUE if Dead Bus conditions are TRUE defined by parameters 8801 ↗ p. 120, 5820 ↗ p. 120, 8805 ↗ p. 120, 8802 ↗ p. 120, 8803 ↗ p. 121 and 8804 ↗ p. 121. Warning No dead bus interlocking.

9.3.4.4 Group 04: Applications Condition

- Applications condition
- Logic command variables 4.01-04.63

These operating statuses may be used as command variable in a logical output to set parameters for customized operations.

No.	Name	Function	Note
04.01	Operat. mode AUTO	AUTOMATIC operating mode active	TRUE in AUTOMATIC operating mode
04.03	Operat. mode MAN	MANUAL operating mode active	TRUE in MANUAL operating mode
04.04	Lamp test	A lamp test is being performed	TRUE if the lamp test is active
04.05	Acknowledge	"Acknowledge" push button has been pressed or an external acknowledgment via LogicsManager	This condition is TRUE for approx. 40 ms and must be extended utilizing a delay time
04.06	Iso.sw./ CBB closed	Isolation switch / CBB is closed	TRUE if DI 5 (Reply isolation switch / CBB) is de-energized
04.07	CBA is closed	CBA is closed only	TRUE if DI 8 (Reply CBA) is de-energized
04.11	Mains settling	Mains settling time active	TRUE in LS5 or single LS5 mode while mains settling time is running.
04.21	Syn. CBA is active	Synchronization CBA is active	TRUE if the CBA shall be synchronized until the CBA is closed
04.22	Opening CBA active	Opening CBA is active	TRUE if an CBA open command is issued until DI 8 (Reply CBA) is energized
04.23	Closing CBA active	Closing CBA is active	TRUE if an CBA close command is issued; same function as relay 5 or 6 (cf. parameter 8800 ↗ p. 121)
04.29	Unloading CBA	CBA unloading sequence is active	TRUE if CBA open with unloading is active.
04.44	Remote Ctrl.Bit1	Free control bit 1 is activated	
04.45	Remote Ctrl.Bit2	Free control bit 2 is activated	
04.46	Remote Ctrl.Bit3	Free control bit 3 is activated	
04.47	Remote Ctrl.Bit4	Free control bit 4 is activated	
04.48	Remote Ctrl.Bit5	Free control bit 5 is activated	
04.49	Remote Ctrl.Bit6	Free control bit 6 is activated	
04.50	Remote Ctrl.Bit7	Free control bit 7 is activated	
04.51	Remote Ctrl.Bit8	Free control bit 8 is activated	
04.52	Remote Ctrl.Bit9	Free control bit 9 is activated	
04.53	Remote Ctrl.Bit10	Free control bit 10 is activated	

No.	Name	Function	Note
04.54	Remote Ctrl.Bit11	Free control bit 11 is activated	
04.55	Remote Ctrl.Bit12	Free control bit 12 is activated	
04.56	Remote Ctrl.Bit13	Free control bit 13 is activated	
04.57	Remote Ctrl.Bit14	Free control bit 14 is activated	
04.58	Remote Ctrl.Bit15	Free control bit 15 is activated	
04.59	Remote Ctrl.Bit16	Free control bit 16 is activated	
04.61	Syn. mains close act.	Synchronous mains closure procedure is active.	<p>TRUE if</p> <ul style="list-style-type: none"> ■ System A detected as mains connected and ■ System B detected as mains connected and ■ Angle is in range (parameter 8821 ↗ p. 127, 8822 ↗ p. 127) and ■ Parameter "Connect synchr. mains (8820 ↗ p. 126) is "Yes" and ■ CBA is enabled and ■ System A is ok and ■ System B is ok.
04.62	Dead bus close act.	Dead bus closure procedure is active.	<p>TRUE if</p> <ul style="list-style-type: none"> ■ Dead bus closure is allowed (parameter 8801 ↗ p. 120) and ■ Dead bus conditions are true (parameter 8802 ↗ p. 120 to 8805 ↗ p. 120, 5820 ↗ p. 120) and ■ CBA is enabled.
04.63	Syn.segm. close act.	Synchronous segments closure procedure is active.	<p>TRUE if</p> <ul style="list-style-type: none"> ■ System A and B are already connected and ■ Angle is in range (parameter 8821 ↗ p. 127, 8822 ↗ p. 127) and ■ Parameter "Connect synchr. segments (8852 ↗ p. 127) is "Yes" and ■ CBA is enabled and ■ System A is ok and ■ System B is ok.

9.3.4.5 Group 05: Device Related Alarms

- Device related alarms
- Logic command variable 05.15

These device alarms may be used as command variable in a logical output to set parameters for customized operations.

No.	Name / Function	Note
05.15	EEPROM failure	<p>TRUE = alarm latched (triggered)</p> <p>FALSE = alarm acknowledged</p>

9.3.4.6 Group 06: System B Related Alarms

- System B related alarms
- Logic command variable 06.21

These system B alarms may be used as command variable in a logical output to set parameters for customized operations.

No.	Name / Function	Note
06.21	SyB. phase rotation	TRUE = alarm latched (triggered) FALSE = alarm acknowledged

9.3.4.7 Group 07: System A Related Alarms

- System A related alarms
- Logic command variables 07.05-07.30

These system A alarms may be used as command variable in a logical output to set parameters for customized operations.

No.	Name / Function	Note
07.05	SyA. phase rotation	TRUE = alarm latched (triggered) FALSE = alarm acknowledged
07.06	SyA. overfrequency (limit) 1	
07.07	SyA. overfrequency (limit) 2	
07.08	SyA. underfrequency (limit) 1	
07.09	SyA. underfrequency (limit) 2	
07.10	SyA. overvoltage (limit) 1	
07.11	SyA. overvoltage (limit) 2	
07.12	SyA. undervoltage (limit) 1	
07.13	SyA. undervoltage (limit) 2	
07.14	SyA. phase shift	
07.15	SyA. df/dt	
07.25	SyA. decoupling	
07.26	SyA. voltage asymmetry	
07.27	SyA. voltage increase	
07.28	Time-dep. voltage	
07.29	SyA. QV mon. (limit) 1	
07.30	SyA. QV mon. (limit) 2	

9.3.4.8 Group 08: System Related Alarms

- System related alarms
- Logic command variables 08.01-08.51

These system alarms may be used as command variable in a logical output to set parameters for customized operations.

No.	Name / Function	Note
08.01	Battery overvoltage (limit) 1	TRUE = alarm latched (triggered) FALSE = alarm acknowledged
08.02	Battery overvoltage (limit) 2	
08.03	Battery undervoltage (limit) 1	
08.04	Battery undervoltage (limit) 2	
08.07	CBA fail to close	
08.08	CBA fail to open	
08.17	Missing LS5	
08.18	CANopen Interface 1	
08.31	Synchronization time CBA	
08.33	Phase rotation mismatch	
08.36	CBA unload mismatch	
08.47	Voltage mismatch	
08.48	Operating range 1	
08.49	Operating range 2	
08.50	Operating range 3	
08.51	Operating range 4	

9.3.4.9 Group 09: Discrete Inputs

- Discrete inputs
- Logic command variables 09.01-09.08

The discrete inputs may be used as command variable in a logical output to set parameters for customized operations.

No.	Name / Function	Note
09.01	DI 1 (Discrete input [DI 01])	TRUE = logical "1" (delay times and N.O./N.C. parameters are ignored) FALSE = logical "0" (alarm has been acknowledged or immediately after TRUE condition is not present anymore, if Control is configured as alarm class)
09.02	DI 2 (Discrete input [DI 02])	
09.03	DI 3 (Discrete input [DI 03])	
09.04	DI 4 (Discrete input [DI 04])	
09.05	DI 5 (Discrete input [DI 05])	
09.06	DI 6 (Discrete input [DI 06])	
09.07	DI 7 (Discrete input [DI 07])	
09.08	DI 8 (Discrete input [DI 08])	

9.3.4.10 Group 11: Clock And Timer

- Clock and timer
- Logic command variables 11.01-11.07

Time functions may be used as command variable in a logical output.

No.	Name / Function	Note
11.01	Timer 1 (exceeded)	Refer to parameters 1652 ↗ p. 150, 1651 ↗ p. 150 and 1650 ↗ p. 150.
11.02	Timer 2 (exceeded)	Refer to parameters 1657 ↗ p. 150, 1656 ↗ p. 150 and 1655 ↗ p. 150.
11.03	Active weekday (equal to setting)	Refer to parameters 1670 ↗ p. 151, 1671 ↗ p. 151, 1672 ↗ p. 151, 1673 ↗ p. 151, 1674 ↗ p. 151, 1675 ↗ p. 151 and 1676 ↗ p. 151.
11.04	Active day (equal to setting)	Refer to parameter 1663 ↗ p. 150 .
11.05	Active hour (equal to setting)	Refer to parameter 1662 ↗ p. 150.
11.06	Active minute (equal to setting)	Refer to parameter 1661 ↗ p. 150.
11.07	Active second (equal to setting)	Refer to parameter 1660 ↗ p. 150.

9.3.4.11 Group 13: Discrete Outputs

- Discrete outputs
- Logic command variables 13.01-13.06

The discrete outputs may be used as command variable in a logical output.

No.	Name / Function	Note
13.01	Discrete output DO1 [R01]	TRUE = logical "1" (this condition indicates the logical status of the internal relays) FALSE = logical "0" (this condition indicates the logical status of the internal relays)
13.02	Discrete output DO2 [R02]	
13.03	Discrete output DO3 [R03]	
13.04	Discrete output DO4 [R04]	
13.05	Discrete output DO5 [R05]	
13.06	Discrete output DO6 [R06]	

9.3.4.12 Group 17: Alarm System 2

- Alarm system 2
- Logic command variables 17.01-17.14

These command variables may be used as command variable in a logical output.

No.	Name / Function	Note
17.01	Missing member 4105	
17.02	Parameter alignment 4105	
17.03	Measurement difference 4105	
17.11	Free alarm 1	

No.	Name / Function	Note
17.12	Free alarm 2	
17.13	Free alarm 3	
17.14	Free alarm 4	

9.3.4.13 Group 24: Flags Condition 2

- Flags condition 2
- Logic command variables 24.31-24.58

The command variables may be used as command variable in a logical output.

'LM' means that these logical command variables show the result of a LogicsManager condition.

No.	Name / Function	Note
24.31	LM Enable SyA decoupling	
24.32	LM Open CBA unload	
24.33	LM Open CBA immediately	
24.34	LM Enable to close CBA	
24.38	LM Variable system is A	
24.39	LM Isolation switch open	
24.40	LM Lock Monitoring	
24.41	LM Flag 1 LS5	
24.42	LM Flag 2 LS5	
24.43	LM Flag 3 LS5	
24.44	LM Flag 4 LS5	
24.45	LM Flag 5 LS5	
24.46	LM Open CBA in MAN	
24.47	LM Close CBA in MAN	
24.51	LM LED 1 (System A in range)	These command variables and the corresponding equations are available in the display version in ToolKit and the HMI, even if the LEDs are not available. In the display version the variables can be used as additional internal flags and are located there.
24.52	LM LED 2 (System B in range)	
24.53	LM LED 3 (Breaker is closed)	
24.54	LM LED 4 (Synchronization is active)	
24.55	LM LED 5 (Breaker close command)	
24.56	LM LED 6 (Breaker open failure)	
24.57	LM LED 7 (Breaker close failure)	
24.58	LM LED 8 (Communication failure)	
	Note: Indicates that the multi-unit missing members monitoring function (parameter 4060 ↗ p. 117) has tripped. See also LogicsManager "LED 8" (parameter 12969 ↗ p. 148).	

9.3.4.14 Group 26/(1-2): Commands Device 33 to 48

- Flags of LS-5 device 33 to 48
- Logic command variables 26.01-26.80

No.	Name / Function	Note
26.01	Flag 1 LS5 device 33	TRUE if LogicsManager 12952 in LS-5 device no. {x} is activated [x = 33 to 48]
26.02	Flag 2 LS5 device 33	TRUE if LogicsManager 12953 in LS-5 device no. {x} is activated [x = 33 to 48]
26.03	Flag 3 LS5 device 33	TRUE if LogicsManager 12954 in LS-5 device no. {x} is activated [x = 33 to 48]
26.04	Flag 4 LS5 device 33	TRUE if LogicsManager 12955 in LS-5 device no. {x} is activated [x = 33 to 48]
26.05	Flag 5 LS5 device 33	TRUE if LogicsManager 12956 in LS-5 device no. {x} is activated [x = 33 to 48]
26.06	Flag 1 LS5 device 34	
26.07	Flag 2 LS5 device 34	
26.08	Flag 3 LS5 device 34	
26.09	Flag 4 LS5 device 34	
26.10	Flag 5 LS5 device 34	
26.11	Flag 1 LS5 device 35	
26.12	Flag 2 LS5 device 35	
26.13	Flag 3 LS5 device 35	
26.14	Flag 4 LS5 device 35	
26.15	Flag 5 LS5 device 35	
26.16	Flag 1 LS5 device 36	
26.17	Flag 2 LS5 device 36	
26.18	Flag 3 LS5 device 36	
26.19	Flag 4 LS5 device 36	
26.20	Flag 5 LS5 device 36	
26.21	Flag 1 LS5 device 37	
26.22	Flag 2 LS5 device 37	
26.23	Flag 3 LS5 device 37	
26.24	Flag 4 LS5 device 37	
26.25	Flag 5 LS5 device 37	
26.26	Flag 1 LS5 device 38	
26.27	Flag 2 LS5 device 38	
26.28	Flag 3 LS5 device 38	
26.29	Flag 4 LS5 device 38	
26.30	Flag 5 LS5 device 38	
26.31	Flag 1 LS5 device 39	

No.	Name / Function	Note
26.32	Flag 2 LS5 device 39	
26.33	Flag 3 LS5 device 39	
26.34	Flag 4 LS5 device 39	
26.35	Flag 5 LS5 device 39	
26.36	Flag 1 LS5 device 40	
26.37	Flag 2 LS5 device 40	
26.38	Flag 3 LS5 device 40	
26.39	Flag 4 LS5 device 40	
26.40	Flag 5 LS5 device 40	
26.41	Flag 1 LS5 device 41	
26.42	Flag 2 LS5 device 41	
26.43	Flag 3 LS5 device 41	
26.44	Flag 4 LS5 device 41	
26.45	Flag 5 LS5 device 41	
26.46	Flag 1 LS5 device 42	
26.47	Flag 2 LS5 device 42	
26.48	Flag 3 LS5 device 42	
26.49	Flag 4 LS5 device 42	
26.50	Flag 5 LS5 device 42	
26.51	Flag 1 LS5 device 43	
26.52	Flag 2 LS5 device 43	
26.53	Flag 3 LS5 device 43	
26.54	Flag 4 LS5 device 43	
26.55	Flag 5 LS5 device 43	
26.56	Flag 1 LS5 device 44	
26.57	Flag 2 LS5 device 44	
26.58	Flag 3 LS5 device 44	
26.59	Flag 4 LS5 device 44	
26.60	Flag 5 LS5 device 44	
26.61	Flag 1 LS5 device 45	
26.62	Flag 2 LS5 device 45	
26.63	Flag 3 LS5 device 45	
26.64	Flag 4 LS5 device 45	
26.65	Flag 5 LS5 device 45	
26.66	Flag 1 LS5 device 46	
26.67	Flag 2 LS5 device 46	
26.68	Flag 3 LS5 device 46	

No.	Name / Function	Note
26.69	Flag 4 LS5 device 46	
26.70	Flag 5 LS5 device 46	
26.71	Flag 1 LS5 device 47	
26.72	Flag 2 LS5 device 47	
26.73	Flag 3 LS5 device 47	
26.74	Flag 4 LS5 device 47	
26.75	Flag 5 LS5 device 47	
26.76	Flag 1 LS5 device 48	
26.77	Flag 2 LS5 device 48	
26.78	Flag 3 LS5 device 48	
26.79	Flag 4 LS5 device 48	
26.80	Flag 5 LS5 device 48	

9.3.4.15 Group 27/(1-2): Commands Device 49 to 64

- Flags of LS-5 device 49 to 64
- Logic command variables 27.01-27.80

No.	Name / Function	Note
27.01	Flag 1 LS5 device 49	TRUE if LogicsManager 12952 in LS-5 device no. {x} is activated [x = 49 to 64]
27.02	Flag 2 LS5 device 49	TRUE if LogicsManager 12953 in LS-5 device no. {x} is activated [x = 49 to 64]
27.03	Flag 3 LS5 device 49	TRUE if LogicsManager 12954 in LS-5 device no. {x} is activated [x = 49 to 64]
27.04	Flag 4 LS5 device 49	TRUE if LogicsManager 12955 in LS-5 device no. {x} is activated [x = 49 to 64]
27.05	Flag 5 LS5 device 49	TRUE if LogicsManager 12956 in LS-5 device no. {x} is activated [x = 49 to 64]
27.06	Flag 1 LS5 device 50	
27.07	Flag 2 LS5 device 50	
27.08	Flag 3 LS5 device 50	
27.09	Flag 4 LS5 device 50	
27.10	Flag 5 LS5 device 50	
27.11	Flag 1 LS5 device 51	
27.12	Flag 2 LS5 device 51	
27.13	Flag 3 LS5 device 51	
27.14	Flag 4 LS5 device 51	
27.15	Flag 5 LS5 device 51	
27.16	Flag 1 LS5 device 52	

No.	Name / Function	Note
27.17	Flag 2 LS5 device 52	
27.18	Flag 3 LS5 device 52	
27.19	Flag 4 LS5 device 52	
27.20	Flag 5 LS5 device 52	
27.21	Flag 1 LS5 device 53	
27.22	Flag 2 LS5 device 53	
27.23	Flag 3 LS5 device 53	
27.24	Flag 4 LS5 device 53	
27.25	Flag 5 LS5 device 53	
27.26	Flag 1 LS5 device 54	
27.27	Flag 2 LS5 device 54	
27.28	Flag 3 LS5 device 54	
27.29	Flag 4 LS5 device 54	
27.30	Flag 5 LS5 device 54	
27.31	Flag 1 LS5 device 55	
27.32	Flag 2 LS5 device 55	
27.33	Flag 3 LS5 device 55	
27.34	Flag 4 LS5 device 55	
27.35	Flag 5 LS5 device 55	
27.36	Flag 1 LS5 device 56	
27.37	Flag 2 LS5 device 56	
27.38	Flag 3 LS5 device 56	
27.39	Flag 4 LS5 device 56	
27.40	Flag 5 LS5 device 56	
27.41	Flag 1 LS5 device 57	
27.42	Flag 2 LS5 device 57	
27.43	Flag 3 LS5 device 57	
27.44	Flag 4 LS5 device 57	
27.45	Flag 5 LS5 device 57	
27.46	Flag 1 LS5 device 58	
27.47	Flag 2 LS5 device 58	
27.48	Flag 3 LS5 device 58	
27.49	Flag 4 LS5 device 58	
27.50	Flag 5 LS5 device 58	
27.51	Flag 1 LS5 device 59	
27.52	Flag 2 LS5 device 59	
27.53	Flag 3 LS5 device 59	

No.	Name / Function	Note
27.54	Flag 4 LS5 device 59	
27.55	Flag 5 LS5 device 59	
27.56	Flag 1 LS5 device 60	
27.57	Flag 2 LS5 device 60	
27.58	Flag 3 LS5 device 60	
27.59	Flag 4 LS5 device 60	
27.60	Flag 5 LS5 device 60	
27.61	Flag 1 LS5 device 61	
27.62	Flag 2 LS5 device 61	
27.63	Flag 3 LS5 device 61	
27.64	Flag 4 LS5 device 61	
27.65	Flag 5 LS5 device 61	
27.66	Flag 1 LS5 device 62	
27.67	Flag 2 LS5 device 62	
27.68	Flag 3 LS5 device 62	
27.69	Flag 4 LS5 device 62	
27.70	Flag 5 LS5 device 62	
27.71	Flag 1 LS5 device 63	
27.72	Flag 2 LS5 device 63	
27.73	Flag 3 LS5 device 63	
27.74	Flag 4 LS5 device 63	
27.75	Flag 5 LS5 device 63	
27.76	Flag 1 LS5 device 64	
27.77	Flag 2 LS5 device 64	
27.78	Flag 3 LS5 device 64	
27.79	Flag 4 LS5 device 64	
27.80	Flag 5 LS5 device 64	

9.3.4.16 Group 28: LS-5 System Conditions

- LS-5 system conditions
- Logic command variables 28.01-28.06

No.	Name / Function	Note
28.01	Command 1 to LS5 easYgen (OR)	TRUE if at least one easYgen sets the command variable to TRUE (OR operation)
28.02	Command 2 to LS5 easYgen (OR)	
28.03	Command 3 to LS5 easYgen (OR)	
28.04	Command 4 to LS5 easYgen (OR)	

No.	Name / Function	Note
28.05	Command 5 to LS5 easYgen (OR)	
28.06	Command 6 to LS5 easYgen (OR)	

9.3.4.17 Group 29(/1-3): Commands Device 1 to 16

- Commands of easYgen device 1 to 16
- Logic command variables 29.01-29.96

No.	Name / Function	Note
29.01	Command 1 easYgen 1	
29.02	Command 2 easYgen 1	
29.03	Command 3 easYgen 1	
29.04	Command 4 easYgen 1	
29.05	Command 5 easYgen 1	
29.06	Command 6 easYgen 1	
29.07	Command 1 easYgen 2	
29.08	Command 2 easYgen 2	
29.09	Command 3 easYgen 2	
29.10	Command 4 easYgen 2	
29.11	Command 5 easYgen 2	
29.12	Command 6 easYgen 2	
29.13	Command 1 easYgen 3	
29.14	Command 2 easYgen 3	
29.15	Command 3 easYgen 3	
29.16	Command 4 easYgen 3	
29.17	Command 5 easYgen 3	
29.18	Command 6 easYgen 3	
29.19	Command 1 easYgen 4	
29.20	Command 2 easYgen 4	
29.21	Command 3 easYgen 4	
29.22	Command 4 easYgen 4	
29.23	Command 5 easYgen 4	
29.24	Command 6 easYgen 4	
29.25	Command 1 easYgen 5	
29.26	Command 2 easYgen 5	
29.27	Command 3 easYgen 5	
29.28	Command 4 easYgen 5	

Appendix

No.	Name / Function	Note
29.29	Command 5 easYgen 5	
29.30	Command 6 easYgen 5	
29.31	Command 1 easYgen 6	
29.32	Command 2 easYgen 6	
29.33	Command 3 easYgen 6	
29.34	Command 4 easYgen 6	
29.35	Command 5 easYgen 6	
29.36	Command 6 easYgen 6	
29.37	Command 1 easYgen 7	
29.38	Command 2 easYgen 7	
29.39	Command 3 easYgen 7	
29.40	Command 4 easYgen 7	
29.41	Command 5 easYgen 7	
29.42	Command 6 easYgen 7	
29.43	Command 1 easYgen 8	
29.44	Command 2 easYgen 8	
29.45	Command 3 easYgen 8	
29.46	Command 4 easYgen 8	
29.47	Command 5 easYgen 8	
29.48	Command 6 easYgen 8	
29.49	Command 1 easYgen 9	
29.50	Command 2 easYgen 9	
29.51	Command 3 easYgen 9	
29.52	Command 4 easYgen 9	
29.53	Command 5 easYgen 9	
29.54	Command 6 easYgen 9	
29.55	Command 1 easYgen 10	
29.56	Command 2 easYgen 10	
29.57	Command 3 easYgen 10	
29.58	Command 4 easYgen 10	
29.59	Command 5 easYgen 10	
29.60	Command 6 easYgen 10	
29.61	Command 1 easYgen 11	
29.62	Command 2 easYgen 11	
29.63	Command 3 easYgen 11	
29.64	Command 4 easYgen 11	
29.65	Command 5 easYgen 11	

No.	Name / Function	Note
29.66	Command 6 easYgen 11	
29.67	Command 1 easYgen 12	
29.68	Command 2 easYgen 12	
29.69	Command 3 easYgen 12	
29.70	Command 4 easYgen 12	
29.71	Command 5 easYgen 12	
29.72	Command 6 easYgen 12	
29.73	Command 1 easYgen 13	
29.74	Command 2 easYgen 13	
29.75	Command 3 easYgen 13	
29.76	Command 4 easYgen 13	
29.77	Command 5 easYgen 13	
29.78	Command 6 easYgen 13	
29.79	Command 1 easYgen 14	
29.80	Command 2 easYgen 14	
29.81	Command 3 easYgen 14	
29.82	Command 4 easYgen 14	
29.83	Command 5 easYgen 14	
29.84	Command 6 easYgen 14	
29.85	Command 1 easYgen 15	
29.86	Command 2 easYgen 15	
29.87	Command 3 easYgen 15	
29.88	Command 4 easYgen 15	
29.89	Command 5 easYgen 15	
29.90	Command 6 easYgen 15	
29.91	Command 1 easYgen 16	
29.92	Command 2 easYgen 16	
29.93	Command 3 easYgen 16	
29.94	Command 4 easYgen 16	
29.95	Command 5 easYgen 16	
29.96	Command 6 easYgen 16	

9.3.4.18 Group 30(/1-3): Commands Device 17 to 32

- Commands of easYgen device 17 to 32
- Logic command variables 30.01-30.96

No.	Name / Function	Note
30.01	Command 1 easYgen 17	
30.02	Command 2 easYgen 17	
30.03	Command 3 easYgen 17	
30.04	Command 4 easYgen 17	
30.05	Command 5 easYgen 17	
30.06	Command 6 easYgen 17	
30.07	Command 1 easYgen 18	
30.08	Command 2 easYgen 18	
30.09	Command 3 easYgen 18	
30.10	Command 4 easYgen 18	
30.11	Command 5 easYgen 18	
30.12	Command 6 easYgen 18	
30.13	Command 1 easYgen 19	
30.14	Command 2 easYgen 19	
30.15	Command 3 easYgen 19	
30.16	Command 4 easYgen 19	
30.17	Command 5 easYgen 19	
30.18	Command 6 easYgen 19	
30.19	Command 1 easYgen 20	
30.20	Command 2 easYgen 20	
30.21	Command 3 easYgen 20	
30.22	Command 4 easYgen 20	
30.23	Command 5 easYgen 20	
30.24	Command 6 easYgen 20	
30.25	Command 1 easYgen 21	
30.26	Command 2 easYgen 21	
30.27	Command 3 easYgen 21	
30.28	Command 4 easYgen 21	
30.29	Command 5 easYgen 21	
30.30	Command 6 easYgen 21	
30.31	Command 1 easYgen 22	
30.32	Command 2 easYgen 22	
30.33	Command 3 easYgen 22	

No.	Name / Function	Note
30.34	Command 4 easYgen 22	
30.35	Command 5 easYgen 22	
30.36	Command 6 easYgen 22	
30.37	Command 1 easYgen 23	
30.38	Command 2 easYgen 23	
30.39	Command 3 easYgen 23	
30.40	Command 4 easYgen 23	
30.41	Command 5 easYgen 23	
30.42	Command 6 easYgen 23	
30.43	Command 1 easYgen 24	
30.44	Command 2 easYgen 24	
30.45	Command 3 easYgen 24	
30.46	Command 4 easYgen 24	
30.47	Command 5 easYgen 24	
30.48	Command 6 easYgen 24	
30.49	Command 1 easYgen 25	
30.50	Command 2 easYgen 25	
30.51	Command 3 easYgen 25	
30.52	Command 4 easYgen 25	
30.53	Command 5 easYgen 25	
30.54	Command 6 easYgen 25	
30.55	Command 1 easYgen 26	
30.56	Command 2 easYgen 26	
30.57	Command 3 easYgen 26	
30.58	Command 4 easYgen 26	
30.59	Command 5 easYgen 26	
30.60	Command 6 easYgen 26	
30.61	Command 1 easYgen 27	
30.62	Command 2 easYgen 27	
30.63	Command 3 easYgen 27	
30.64	Command 4 easYgen 27	
30.65	Command 5 easYgen 27	
30.66	Command 6 easYgen 27	
30.67	Command 1 easYgen 28	
30.68	Command 2 easYgen 28	
30.69	Command 3 easYgen 28	
30.70	Command 4 easYgen 28	

Appendix

No.	Name / Function	Note
30.71	Command 5 easYgen 28	
30.72	Command 6 easYgen 28	
30.73	Command 1 easYgen 29	
30.74	Command 2 easYgen 29	
30.75	Command 3 easYgen 29	
30.76	Command 4 easYgen 29	
30.77	Command 5 easYgen 29	
30.78	Command 6 easYgen 29	
30.79	Command 1 easYgen 30	
30.80	Command 2 easYgen 30	
30.81	Command 3 easYgen 30	
30.82	Command 4 easYgen 30	
30.83	Command 5 easYgen 30	
30.84	Command 6 easYgen 30	
30.85	Command 1 easYgen 31	
30.86	Command 2 easYgen 31	
30.87	Command 3 easYgen 31	
30.88	Command 4 easYgen 31	
30.89	Command 5 easYgen 31	
30.90	Command 6 easYgen 31	
30.91	Command 1 easYgen 32	
30.92	Command 2 easYgen 32	
30.93	Command 3 easYgen 32	
30.94	Command 4 easYgen 32	
30.95	Command 5 easYgen 32	
30.96	Command 6 easYgen 32	

9.3.5 Factory Settings

Internal flags

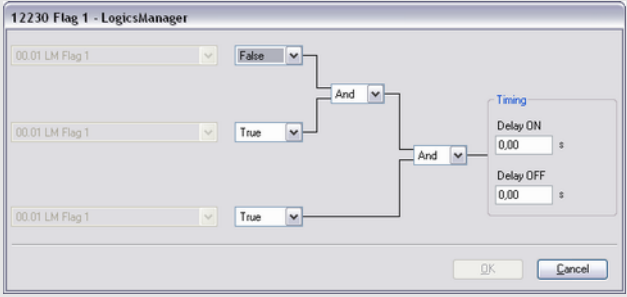
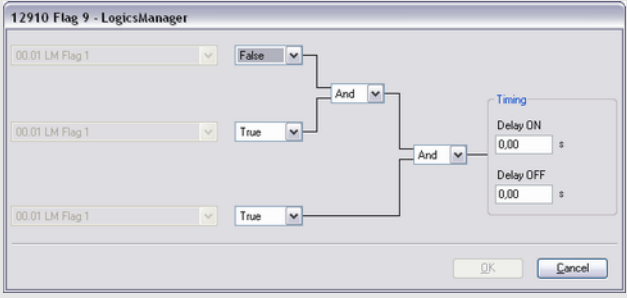
Simple (function)	Extended (configuration)	Result
<p>[00.0x] Flag {x}; {x} = 1 to 8</p> <p>If TRUE, flag {x} becomes TRUE. Deactivated by default.</p>		<p>FALSE</p>
<p>[00.3x] Flag {y}; {x} = 0 to 7, {y} = 9 to 16</p> <p>If TRUE, flag {y} becomes TRUE. Deactivated by default.</p>		<p>FALSE</p>

Internal Functions

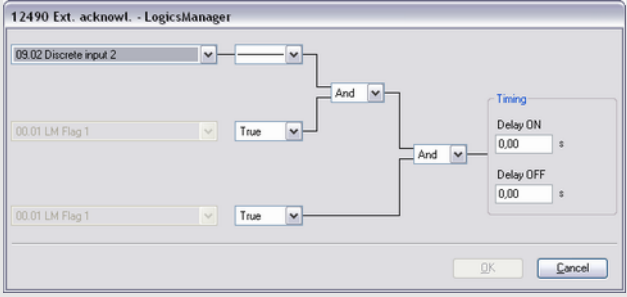
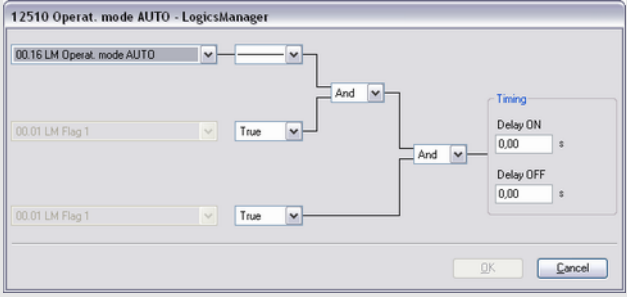
Simple (function)	Extended (configuration)	Result
<p>[00.15] External acknowledgment</p> <p>If TRUE, all alarms are acknowledged from an external source. TRUE once discrete input [DI 2] is energized.</p>		<p>dependent on discrete input [DI 2]</p>
<p>[00.16] Operation mode AUTOMATIC</p> <p>If TRUE the unit changes into AUTOMATIC operating mode. Deactivated by default. Only available in operating mode "MAN" and application mode 001 to 002.</p>		<p>FALSE</p>
<p>[00.17] Operation mode MANUAL</p>		

Simple (function)	Extended (configuration)	Result
<p>If TRUE the unit changes into MANUAL operating mode.</p> <p>Deactivated by default.</p> <p>Only available in operating mode "AUTO" and application mode #01 to #02.</p>		FALSE
[00.38] Synchronization Mode CHECK		
<p>If TRUE, synchronization mode CHECK is enabled.</p> <p>Deactivated by default.</p> <p>Only available in application mode #01 to #02.</p>		FALSE
[00.39] Synchronization Mode PERM		
<p>If TRUE, synchronization mode PERMISSIVE is enabled.</p> <p>Deactivated by default.</p> <p>Only available in application mode #01 to #02.</p>		FALSE
[00.40] Synchronization Mode RUN		
<p>If TRUE, synchronization mode RUN is enabled.</p> <p>Deactivated by default.</p> <p>Only available in application mode #01 to #02.</p>		FALSE
[00.95] Lock keypad		
<p>If TRUE, the Lock keypad function is activated.</p> <p>Deactivated by default.</p>		FALSE

Relay outputs

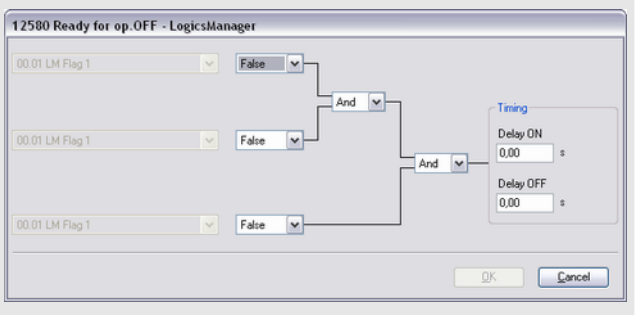
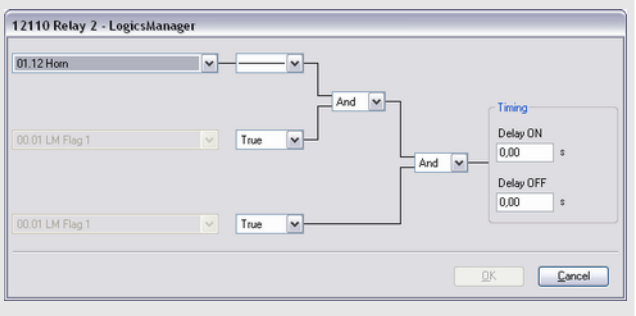
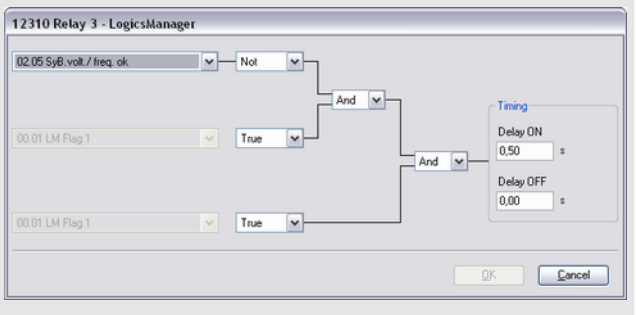
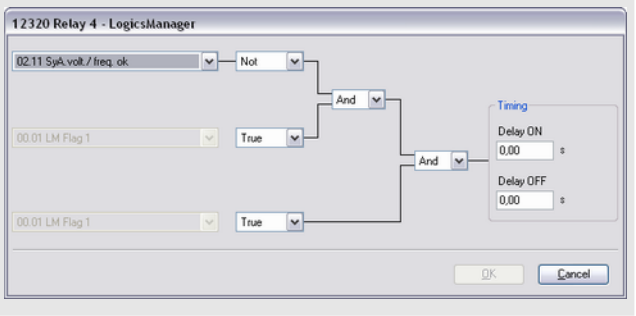
Simple (function)	Extended (configuration)	Result
[00.41] Relay 1 [R01] - Ready for operation OFF		
<p>Relay will be de-energized if unit is not ready for operation or the logics manager output is TRUE.</p> <p>LM output is deactivated by default</p> <p>The unit is only ready for operation after a start-up delay following the power supply connection.</p>		FALSE
[00.42] Relay 2 [R02] - Horn / freely configurable		
<p>Relay energizes if the internal condition "Horn" is TRUE</p>		dependent on Logics Command Variable [01.12]
[00.43] Relay 3 [R03] - System B voltage/frequency not OK / freely configurable		
<p>Relay energizes if the internal condition "SyB volt/freq. ok" is FALSE</p>		dependent on Logics Command Variable [02.05]
[00.44] Relay 4 [R04] - System A voltage/frequency not OK / freely configurable		
<p>Relay energizes if the internal condition "SyA volt/freq. ok" is FALSE</p>		dependent on Logics Command Variable [02.11]
[00.45] Relay 5 [R05] - Command: open CBA		
Fixed function "Open CBA"	Not configurable	

Simple (function)	Extended (configuration)	Result
[00.46] Relay 6 [R06] – Close CBA (in CBA: two relay mode) / All alarm classes		
In two relay mode fixed to "close CBA". Otherwise the relay energizes if "All alarm classes" is TRUE		FALSE

Discrete inputs

DI	Alarm class		Pre-assigned to
1	CONTROL	freely configurable	LogicsManager 'Lock monitoring'
2	CONTROL	freely configurable	LogicsManager 'Remote acknowledge'
3	CONTROL	freely configurable	LogicsManager 'Enable decoupling'
4	CONTROL	freely configurable	LogicsManager 'Immediate open CBA'
5	CONTROL	freely configurable	LogicsManager 'Reply: Isolation switch is open'
6	CONTROL	freely configurable	LogicsManager 'Open CBA (with unloading)'
7	CONTROL	freely configurable	LogicsManager 'Enable to close CBA'
8		fixed	Reply: CBA is open

9.4 Event And Alarm Reference

9.4.1 Alarm Classes

 *The control functions are structured in the following alarm classes:*

Alarm class	Visible in the display	LED "Alarm" & horn	Relay "Command: open CBA"
A	yes	no	no
Warning Alarm	This alarm does not open a breaker. A message output without a centralized alarm occurs: <ul style="list-style-type: none"> Alarm text. 		
B	yes	yes	no
Warning Alarm	This alarm does not open a breaker. An output of the centralized alarm occurs and the command variable 3.05 (horn) is issued. <ul style="list-style-type: none"> Alarm text + flashing LED "Alarm" + Relay centralized alarm (horn). 		
C	yes	yes	with unloading
Shutdown Alarm	With this alarm the CBA is opened with unloading. <ul style="list-style-type: none"> Alarm text + flashing LED "Alarm" + Relay centralized alarm (horn) + CBA open with unloading . 		
D	yes	yes	immediately

Alarm class	Visible in the display	LED "Alarm" & horn	Relay "Command: open CBA"
Shutdown Alarm	With this alarm the CBA is opened immediately. ■ Alarm text + flashing LED "Alarm" + Relay centralized alarm (horn) + CBA open immediately.		
E	yes	yes	immediately
Shutdown Alarm	With this alarm the CBA is opened immediately. ■ Alarm text + flashing LED "Alarm" + Relay centralized alarm (horn)+ CBA open immediately.		
F	yes	yes	immediately
Shutdown Alarm	With this alarm the CBA is opened immediately. ■ Alarm text + flashing LED "Alarm" + Relay centralized alarm (horn)+ CBA open immediately.		
Control	no	no	no
Control Signal	This signal issues a control command only. It may be assigned to a discrete input for example to get a control signal, which may be used in the LogicsManager. No alarm message and no entry in the alarm list or the event history will be issued. This signal is always self-acknowledging, but considers a delay time and may also be configured with "Monitoring lockable".		

9.4.2 Status Messages

Message text ID	Meaning
CBA dead bus close 13210	Dead bus closing of the CBA The CBA is closing with at least one system is dead.
CBA open 13257	The CBA is being opened An CBA open command has been issued.
CBA request 13280	CBA request There is a command to open or close the CBA, but the execution is already blocked by the priority of a breaker command of another LS-5/GCB or the LS-5 is still arbitrating the priority.
Mains settling 13205	Mains settling time is active When the control unit detects that a mains (system A) fault is in range again the mains settling timer begins counting down. The mains (system A) is assumed as stable after the expiration of this timer. If the timer is running a synchronization of CBA is not possible.
Syn. mains close CBA 13279	Synchronous mains close CBA The LS-5 has detected that System A and System B are connected to mains and is closing the CBA according to parameters 8820 ↪ p. 126, 8821 ↪ p. 127 and 8822 ↪ p. 127.
Syn. segm. close CBA 13286	Synchronous segment close CBA The LS-5 has detected that System A and System B are already alternatively connected and is closing the CBA according to parameters 8852 ↪ p. 127, 8821 ↪ p. 127 and 8822 ↪ p. 127.
Synch. CHECK 13266	Synchronization mode Check (twinkling) Synchronization mode is set to Check (parameter 5728 ↪ p. 125)
Synch. OFF 13267	Synchronization mode Off (twinkling) Synchronization mode is set to Off (parameter 5728 ↪ p. 125)
Synch. PERMISSIVE 13265	Synchronization mode Permissive (twinkling) Synchronization mode is set to Permissive (parameter 5728 ↪ p. 125)
Synchronization CBA 13260	The CBA will be synchronized The control tries to synchronize the CBA.
Unloading CBA 13264	The CBA will open with unloading The LS-5 wants to open the CBA with unloading and is waiting until the power reaches the value defined by parameter 8819 ↪ p. 108.

9.4.3 Event History

General notes

The event history is a 300 entry FIFO (First In/First Out) memory for logging alarm events and operation states of the unit. As new event messages are entered into the history, the oldest messages are deleted once 300 events have occurred.

For additional information refer to [Chapter 5 "Operation"](#) on page 153.

Resetting event history

1. 



Make sure to have set the appropriate code level to reset the event history.

If you have not entered the correct password for the required code level, the parameters for resetting the event history are not available (for additional information refer to [Chapter 4.1.5 "Password System"](#) on page 74).

2. 

Reset the event history by setting the parameter "Clear event-log" (parameter 1706 [p. 74](#)) to "Yes" via the front panel.

⇒ The complete event history is now being cleared.

9.4.3.1 Event Messages

Message text ID	Meaning
AUTO mode 14353	Auto mode became active
Close command CBA 14730	CBA close command became active
Feedback CBA close 14701	CBA close (reply CBA open became)
Feedback CBA open 14700	Reply CBA open became active
MAN mode 14355	Manual mode became active
Open command CBA 14731	CBA open command became active
Start up power 14778	Power up cycle happened
System A is ok 14724	System A became ok (Voltage and frequency in range)
System B is ok 14727	System B became ok (Voltage and frequency in range)

9.4.3.2 Alarm Messages



For a detailed description of the monitoring functions, which trigger the alarm messages, refer to [Chapter 4.3.1 “System A” on page 79](#).

Message text ID	Meaning
4105 Para. alignment 5111	VDE-AR-N 4105 Parameter alignment (System A) Monitoring mode 'Single' 3110 ↪ p. 82: The checksum of the own parameters does not match with the checksum of the dedicated VDE-AR-N 4105 device partner within 6 s. Monitoring mode 'Multi' 3110 ↪ p. 82: The checksum of the own parameters does not match with the checksum of the majority of the VDE-AR-N 4105 device partners within 6 s.
Bat. overvoltage 1 10007	Battery overvoltage, limit value 1 The battery voltage has exceeded the limit value 1 for battery overvoltage for at least the configured time and did not fall below the value of the hysteresis.
Bat. overvoltage 2 10008	Battery overvoltage, limit value 2 The battery voltage has exceeded the limit value 2 for battery overvoltage for at least the configured time and did not fall below the value of the hysteresis.
Bat. undervoltage 1 10005	Battery undervoltage, limit value 1 The battery voltage has fallen below the limit value 1 for battery undervoltage for at least the configured time and has not exceeded the value of the hysteresis.
Bat. undervoltage 2 10006	Battery undervoltage, limit value 2 The battery voltage has fallen below the limit value 2 for battery undervoltage for at least the configured time and has not exceeded the value of the hysteresis.
CANopen Interface 1 10087	Interface alarm CANopen on CAN bus 1 No Receive Process Data Object (RPDO) is received within the configured time.
CBA fail to close 2623	CBA failed to close The LS-5 has attempted to close the CBA the configured maximum number of attempts and failed. The LS-5 will continue to attempt to close the CBA as long as the conditions for closing the CBA are fulfilled.
CBA fail to open 2624	Failed CBA open The LS-5 is still receiving the reply CBA closed after the CBA open monitoring timer has expired.
CBA syn. timeout 3074	CBA synchronization time exceeded The LS-5 has failed to synchronize the CBA within the configured synchronization time.
CBA unload mismatch 8838	CBA unloading mismatch While unloading CBA the defined limit of load is not reached in the defined time.
Discrete input {x} [x = 1 to 8] 10600 .. 10608	Discrete input {x}, energized / de-energized The actual state of the monitored discrete input is energized / de-energized (depending on the configuration) for at least the configured time. This text may be assigned customer defined. The text in angular brackets is the default text. Refer to ↪ “Message IDs for discrete inputs” on page 390.
EEPROM failure 1714	The EEPROM checksum is corrupted The EEPROM check at startup has resulted a defective EEPROM.

Message text ID	Meaning
Free alarm {x} [x = 1 to 4] Free alarm 1: 5165 Free alarm 2: 5171 Free alarm 3: 5177 Free alarm 4: 5183	Free alarm {x} The dedicated Free alarm {x} is triggered
Meas.diff. 4105 5117	VDE-AR-N 4105 Measurement difference detected The measurement tolerance for mains frequency and voltage values can be configured. Monitoring mode 'Single' 3110 ↪ p. 82: A single measurement value does not match with the value of the dedicated 4105 VDE-AR-N device partner within a time of 3.5 s. Monitoring mode 'Multi' 3110 ↪ p. 82: A single measurement value does not match with the values of the majority of the VDE-AR-N 4105 device partners within a time of 3.5 s.
Missing LS5 4064	Missing LS-5 members detected The LS-5 has detected that the number of available units at the CAN bus does not correspond with the configured application mode.
Missing member4105 5105	VDE-AR-N 4105 Missing member detected Monitoring mode 'Single' 3110 ↪ p. 82: The diagnose message of the dedicated VDE-AR-N 4105 device partner is not received within a determined time of 3.5 s. Monitoring mode 'Multi' 3110 ↪ p. 82: Any diagnose message of a VDE-AR-N 4105 device partner is not received within a determined time of 3.5 s.
Oper. range 1 2665	Operating range 1 Operating range 1: CAN consideration For details see chapter ↪ <i>Chapter 4.3.5 "Operating range" on page 111</i>
Oper. range 2 2666	Operating range 2 Operating range 2: Synchronous networks For details see chapter ↪ <i>Chapter 4.3.5 "Operating range" on page 111</i>
Oper. range 3 2667	Operating range 3 Operating range 3: CBA dead bus closure For details see chapter ↪ <i>Chapter 4.3.5 "Operating range" on page 111</i>
Oper. range 4 2668	Operating range 4 Operating range 4: CBA synchronization For details see chapter ↪ <i>Chapter 4.3.5 "Operating range" on page 111</i>
Ph.rotation mismatch 2944	System A/System B phase rotation difference System A or System B has different rotating fields. A CB closure is blocked.
SyA. decoupling 3114	System A decoupling is initiated One or more monitoring function(s) considered for the system A decoupling functionality has triggered.
SyA. df/dt 3106	System A df/dt (ROCOF) A system A df/dt, which has exceeded the configured limit, has occurred. Triggering this monitoring function causes the system A decoupling function to trigger.
SyA. overfreq. 1 2862	System A overfrequency, limit value 1 The system A frequency has exceeded the limit value 1 for system A overfrequency for at least the configured time and did not fall below the value of the hysteresis.

Message text ID	Meaning
SyA. overfreq. 2 2863	System A overfrequency, limit value 2 The system A frequency has exceeded the limit value 2 for system A overfrequency for at least the configured time and did not fall below the value of the hysteresis. Triggering this monitoring function causes the mains decoupling function to trigger.
SyA. overvoltage 1 2962	System A overvoltage, limit value 1 The system A voltage has exceeded the limit value 1 for system A overvoltage for at least the configured time and did not fall below the value of the hysteresis.
SyA. overvoltage 2 2963	System A overvoltage, limit value 2 The system A voltage has exceeded the limit value 2 for system A overvoltage for at least the configured time and did not fall below the value of the hysteresis. Triggering this monitoring function causes the mains decoupling function to trigger.
SyA. phase shift 3057	System A phase shift A system A phase shift, which has exceeded the configured limit, has occurred. Triggering this monitoring function causes the system A decoupling function to trigger.
SyA. phase rotation 3975	System A rotating field The system A rotating field does not correspond with the configured direction.
SyA. QV mon. 1 3288	QV monitoring, delay time 1 The system A reactive power has exceeded the limit for at least the configured delay time 1.
SyA. QV mon. 2 3289	QV monitoring, delay time 2 The system A reactive power has exceeded the limit for at least the configured delay time 2.
SyA. time-dep. voltage 4958	System A time-dependent voltage The measured voltage falls below/exceeds the configured criteria.
SyA. underfreq. 1 2912	System A underfrequency, limit value 1 The system A frequency has fallen below the limit value 1 for system A underfrequency for at least the configured time and has not exceeded the value of the hysteresis.
SyA underfreq. 2 2913	System A underfrequency, limit value 2 The system A frequency has fallen below the limit value 2 for system A underfrequency for at least the configured time and has not exceeded the value of the hysteresis. Triggering this monitoring function causes the mains decoupling function to trigger.
SyA. undervoltage 1 3012	System A undervoltage, limit value 1 The system A voltage has fallen below the limit value 1 for system A undervoltage for at least the configured time and has not exceeded the value of the hysteresis.
SyA. undervoltage 2 3013	System A undervoltage, limit value 2 The system A voltage has fallen below the limit value 2 for system A undervoltage for at least the configured time and has not exceeded the value of the hysteresis. Triggering this monitoring function causes the mains decoupling function to trigger.
SyA. volt. asymmetry 3928	System A voltage asymmetry For at least the delay time without interruption.
SyA. volt. incr. 8834	System A voltage increase The limit for voltage increase is reached or exceeded.
SyB. phase rotation 3955	System B rotating field The system A rotating field does not correspond with the configured direction.
Voltage mism. 2996	Voltage mismatch The flags of System A (02.09 'SyA. Voltage ok') and System B (02.03 'SyB. Voltage ok') do not have the same status or the phase angle between both systems is +/-10° or more.

Message IDs for discrete inputs

Discrete input #	1	2	3	4	5	6	7
Message ID	10600	10601	10602	10603	10604	10605	10607

9.5 Additional Application Information

9.5.1 Synchronization Of System A and System B

Synchronization Table

The table below gives an overview about the synchronization of systems A with system B.

Drawing index:

- Yes: The synchronization is executed
- blocked: The synchronization is blocked
- n.a.: not applicable (not possible to configure)
- Not allowed (*1:
The neutral could not be located in the middle of the delta voltages
- Not allowed (*2:
These constellations are not applicable

System A \ System B		1Ph2W				3Ph4W		3Ph3W		1Ph3W (Ph-N)	
		Ph-Ph		Ph-N		left	right	left	right		
		left	right	left	right						
1Ph2W	Ph-Ph	left	Yes	n.a.	n.a.	n.a.	Yes	blocked	Yes	blocked	Not allowed (*2)
		right	n.a.	Yes	n.a.	n.a.	blocked	Yes	blocked	Yes	Not allowed (*2)
	Ph-N	left	n.a.	n.a.	Yes	n.a.	Yes	blocked	Not allowed (*1)	blocked	Yes
		right	n.a.	n.a.	n.a.	Yes	blocked	Yes	blocked	Not allowed (*1)	Yes
3Ph4W 3Ph4W OD	left	Yes	blocked	Yes	blocked	Yes	blocked	Yes	blocked	Not allowed (*2)	
	right	blocked	Yes	blocked	Yes	blocked	Yes	blocked	Yes	Not allowed (*2)	
3Ph3W	left	Yes	blocked	Not allowed (*1)	blocked	Yes	blocked	Yes	blocked	Not allowed (*2)	
	right	blocked	Yes	blocked	Not allowed (*1)	blocked	Yes	blocked	Yes	Not allowed (*2)	
1Ph3W	(Ph-N)	Not allowed (*2)	Not allowed (*2)	Yes	Yes	Not allowed (*2)	Not allowed (*2)	Not allowed (*2)	Not allowed (*2)	Yes	

Fig. 174: LS-5 Synchronization Table - Two Systems A-B

10 Glossary And List Of Abbreviations

CB	Circuit Breaker
CL	Code Level
CT	Current Transformer
DI	Discrete Input
DO	Discrete (Relay) Output
ECU	Engine Control Unit
FMI	Failure Mode Indicator
GCB	Generator Circuit Breaker
GGB	Generator Group Breaker
I	Current
IOP	Isolated Operation in Parallel
LDSS	Load-Dependent Start/Stop operation
MCB	Mains Circuit Breaker
MOP	Mains Operation in Parallel
MPU	Magnetic Pickup Unit
N.C.	Normally Closed (break) contact
N.O.	Normally Open (make) contact
OC	Occurrence Count
P	Real power
P/N	Part Number
PF	Power Factor
PID	Proportional Integral Derivative controller
PLC	Programmable Logic Control
PT	Potential (Voltage) Transformer
Q	Reactive power
S	Apparent power
S/N	Serial Number
SPN	Suspect Parameter Number
V	Voltage

11 Index

1, 2, 3 ...

2 breaker 25

A

Alarms 118

 Alarm Classes 384

 Free configurable 115

B

Battery

 Monitoring 113, 114

C

CAN

 Monitoring 112

CBA 106

 Unload Mismatch 108

Contact person 17

Counters 151

Customer Service 17

H

HMI 167

Home Screen 169

I

Intended use 17

L

Load calculation 57

LogicsManager

 Command Variables 360

O

Operating Range Monitoring 111

P

Personnel 18

Phase Rotation

 System A / System B 109

Protective equipment 22

S

Service 17

Symbols

 in the instructions 15

Synchronization 390

System A

 Decoupling 81

 df/dt (ROCOF) 84

 Operating Voltage / Frequency 80

 Overfrequency 85

 Overvoltage 87

 Phase Rotation 102

 Phase Shift 82

 QV Monitoring 97

 Time-Dependent Voltage 99

 Underfrequency 86

 Undervoltage 88

 Voltage asymmetry 90

 Voltage Increase 91

System B

 Operating Voltage / Frequency 104

 Phase Rotation 105

U

Use 17

V

Variants 15

VDE-AR-N 4105 93

Voltage

 Monitoring 110, 111

W

Warranty 17



Woodward GmbH

Handwerkstrasse 29 - 70565 Stuttgart - Germany

Phone +49 (0) 711 789 54-510

Fax +49 (0) 711 789 54-101

stgt-info@woodward.com