

MANUAL

Professional Line | PROTECTION TECHNOLOGY
MADE SIMPLE

XN2 | MAINS DECOUPLING RELAY

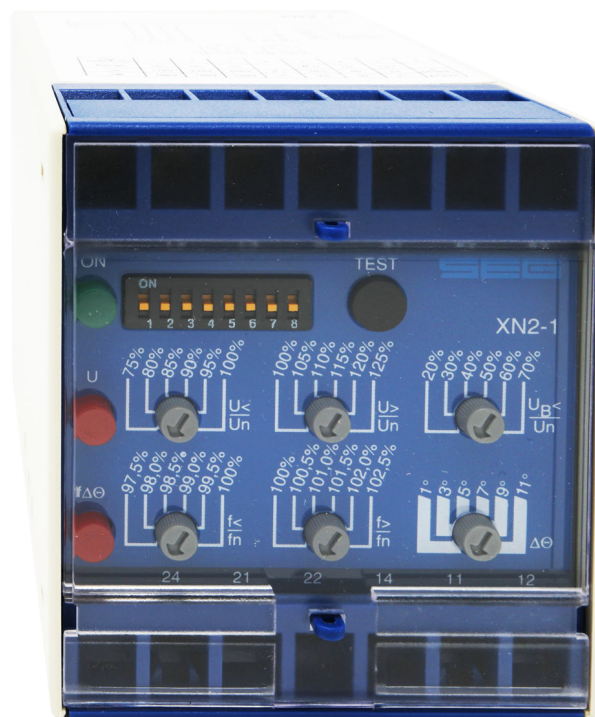

MAINS DECOUPLING RELAY

Original document

English

Revision: D

**SEG Electronics GmbH reserves the right to update any portion of this publication at any time.
Information provided by SEG Electronics GmbH is believed to be correct and reliable.
However, no responsibility is assumed by SEG Electronics GmbH unless otherwise expressly undertaken.**

© SEG Electronics GmbH 1994–2020

Contents

1. Applications and features	4
2. Design	5
3. Function.....	7
3.1 Voltage supervision	7
3.2 Frequency supervision	7
3.3 The vector surge and frequency gradient supervision	7
3.3.1 Measuring principle vector surge and frequency gradient supervision	8
3.3.2 Mains failure detection	9
4. Operation and settings	10
4.1 Setting of DIP-switches	12
4.2 Setting of the tripping values	14
4.3 Communication via serial interface adapter XRS1	15
5. Relay case and technical data	16
5.1 Relay case.....	16
5.2 Technical data	17
6. Order form	20

1. Applications and features

Unit XN2 of the PROFESSIONAL LINE is an universal mains decoupling device and contains the protective functions required of VDEW and most other utilities for the mains parallel operation of power stations:

- over- and undervoltage protection
- over- and underfrequency protection
- Phase sequence supervision

In addition to this relay XN2-1 has the following special feature:

- fast decoupling of the generator in case of mains failure

In addition to this relay XN2-2 has the following special feature:

- fast decoupling of the generator via frequency gradient supervision

When compared to conventional devices an exceptional price/performance ratio is achieved by integration of 4 protective functions in one device.

For applications where only single protection functions are required SEG Electronics GmbH certainly offers the X-relays also as single devices:

- XU2-AC Alternating voltage relay
- XF2 Frequency relay
- XG2 Vector surge relay

When compared to the conventional protection equipment all relays of the PROFESSIONAL LINE reflect the superiority of digital protection techniques with the following features:

- High measuring accuracy by digital data processing
- Fault indication via LEDs
- Extremely wide operating ranges of the supply volt-age by universal wide-range power supply
- Very fine graded wide setting ranges
- Data exchange with process management system by serial interface adapter XRS1 which can be retrofitted
- RMS measurement
- Extremely short response time
- Compact design by SMD-technology

2. Design

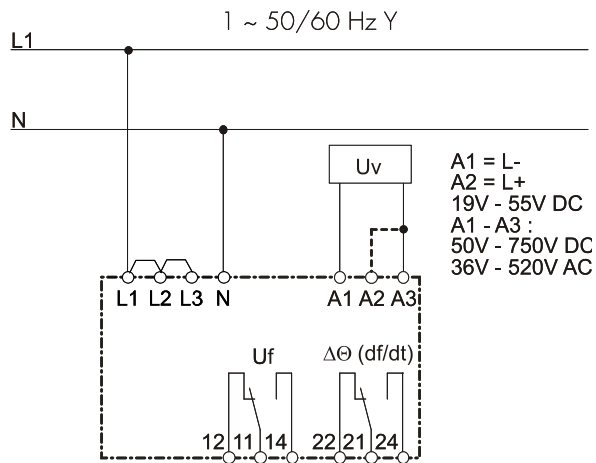

Figure 2.1: Connection two-wire system

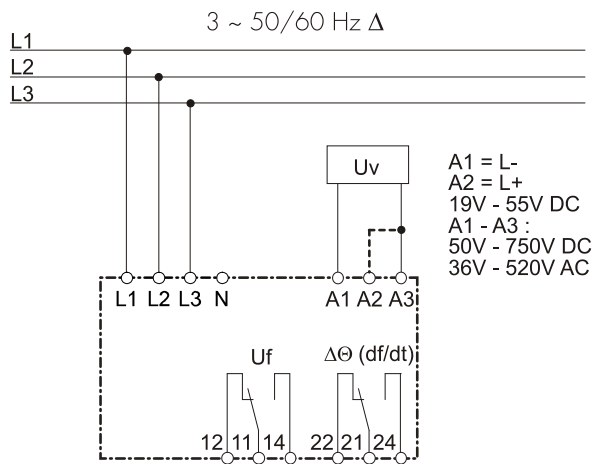

Figure 2.2: Connection three-wire system

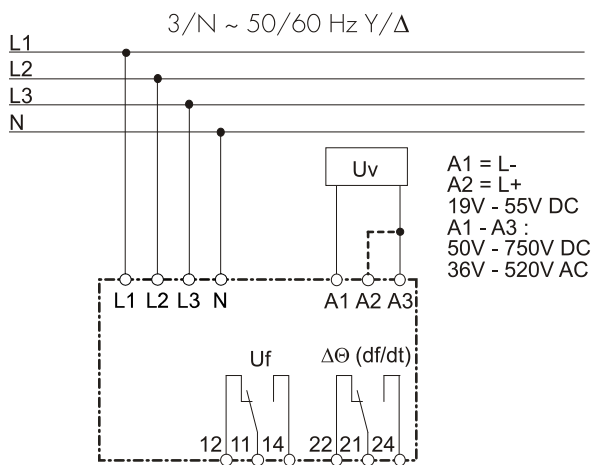

Figure 2.3: Connection four-wire system

Analog inputs

The analog input signals of the voltages are connected to the protection device via terminals L1 - L3 and N.

Auxiliary voltage supply

Unit XN2 can be supplied directly from the measuring quantity itself or by a secured auxiliary supply. Therefore a DC or AC voltage must be used.

Unit XN2 has an integrated wide range power supply. Voltages in the range from 19 - 55 V DC can be applied at connection terminals A1(L-) and A2(L+).

Terminals A1/A3 are to be used for voltages from 50 - 750 V DC or from 36 - 520 V AC (f = 35 - 78 Hz).

Contact positions

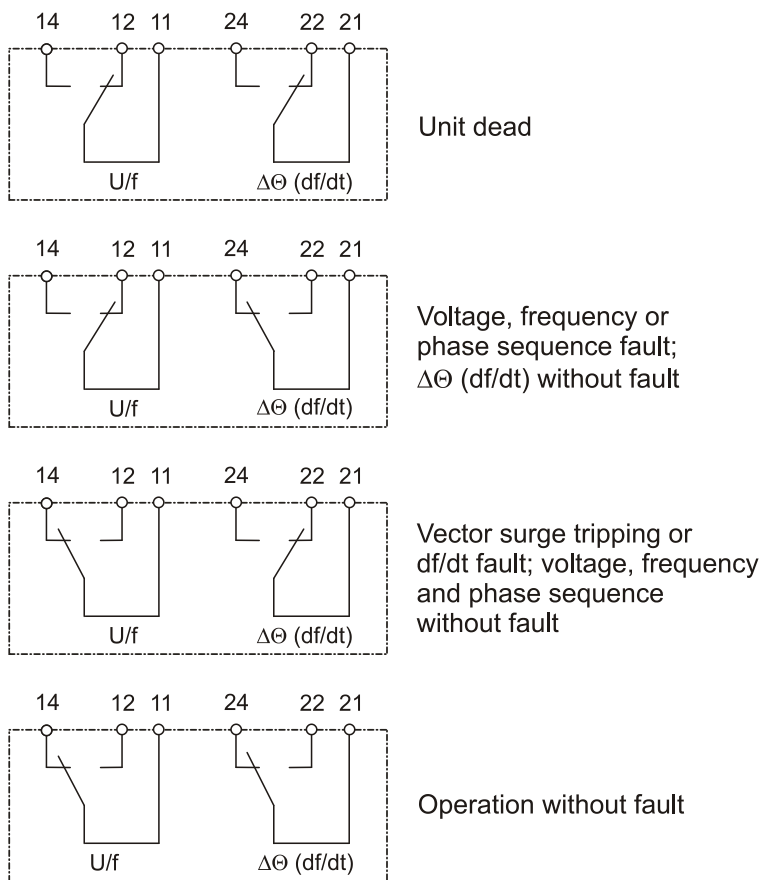

Figure 2.4: Contact positions of the output relays

3. Function

3.1 Voltage supervision

The XN2 has an independent under- and overvoltage supervision. During 3-phase measuring the voltage is permanently compared with the set reference values.

For overvoltage supervision always the highest value is evaluated, for undervoltage supervision always the lowest value.

Tripping at undervoltage is indicated by flashing LED U, whereas at overvoltage LED U is steady lit.

3.2 Frequency supervision

For frequency supervision the cycle time is evaluated and so measuring is virtually independent on harmonic influences. To avoid tripping during normal operation due to voltages transients and phase transients - a fixed measuring repetition is used.

Supervision of the frequency is 3-phase. Each of the phases is individually monitored. Pickup or tripping only after the set reference value in at least one phase is exceeded or not reached.

Tripping at underfrequency $f <$ is indicated by flashing of the LED $f\Delta\Theta$ or df/dt . At overfrequency LED $f\Delta\Theta$ or df/dt lights up permanently. If the measuring voltage drops below $U_{B<}$, supervision of the frequency is blocked.

3.3 The vector surge and frequency gradient supervision

Synchronous generators are particularly endangered in the event of mains failures and mains auto reclosing: The returning mains voltage could hit the generator in asynchronous mode. A vector surge supervision or a frequency gradient supervision protect the generator by fast shut-down in case of mains faults.

Generally there are two different applications:

- a) Only mains parallel operation no single operation. In this application: protection of the generator by tripping the generator circuit breaker in case of mains failure.
- b) Mains parallel operation and single operation. For this application: Protection via tripping the mains circuit breaker in case of mains failure.

Therefore it is ensured that the generator isn't blocked when needed as emergency power plant.

3.3.1 Measuring principle vector surge and frequency gradient supervision

When a synchronous alternator is loaded, the rotor displacement angle ϑ is build between the terminal voltage (mains voltage U_1) and the synchronous electromotive force (U_p).

The rotor displacement angle ϑ between stator and rotor is depending of the mechanical moving torque of the generator shaft. The mechanical shaft power is balanced with the electrical feeded mains power, and therefore the synchronous speed keeps constant.

In case of mains failure the generator suddenly feeds a very high consumer load. The rotor displacement angle and the voltage vector U_1 change its direction abruptly.

At the same time the changing of power flow due to the interrupted mains connection leads to a frequency change (linear rise or fall), depending on the direction of power flow. The occurring frequency change is, at the same time, also dependent on the type of drive of the synchronous generator (mass inertia), the type of consumer and the type of switch operations.

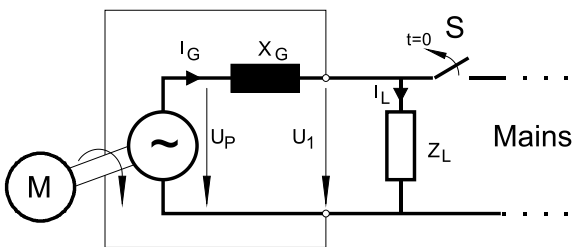

Figure 3.1: Simple equivalent of a synchronous generator

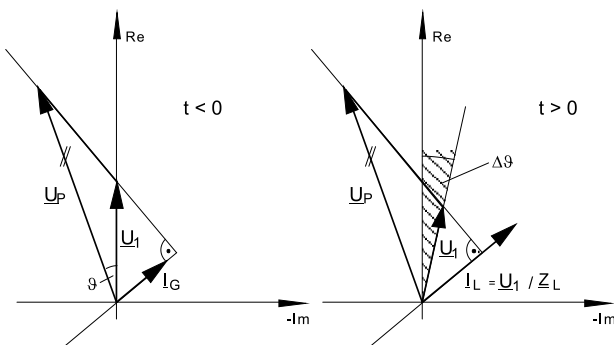

Figure 3.2: Vector diagram rotor displacement angle and voltage vector

Mains failure detection

The XN2-1 detects a mains failure by means of the vector surge supervision (Fig. 3.3). The device has an internal reference by which it can continuously determine the time up to the next voltage zero passage. The measured time difference is proportional to the displacement angle ϑ . Tripping takes place if and when an angle displacement exceeds the set limit value. Continuous checking over 4 periods prevents faulty trippings by switch operations.

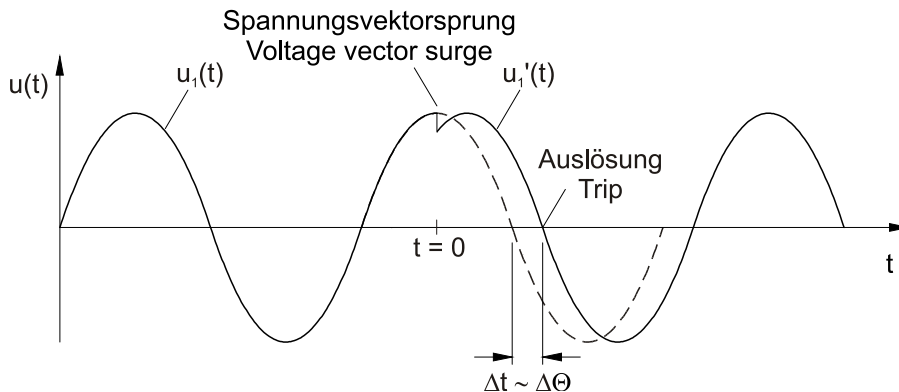

Figure 3.3: Generator voltage at mains shut-down

The XN2-2 detects a mains failure by means of the frequency gradient supervision (Fig. 3.4). The device records the direction and speed of frequency change. Tripping takes place if and when the speed of frequency change in constant direction exceeds the set limit value. Continuous checking over 4 to 8 periods (adjustable measuring sequence time) prevents faulty trippings by switch operations.

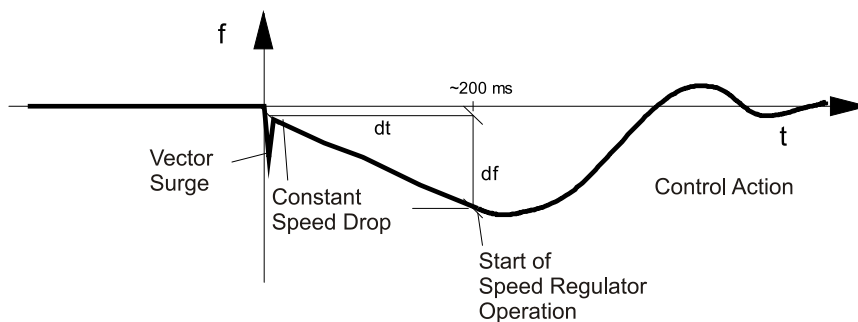

Figure 3.4: Frequency progress after mains shut-down

4. Operation and settings

All operating elements needed for setting parameters are located on the front plate of unit XN2 as well as all display elements.

Because of this all adjustments of the unit can be made or changed without disconnecting the unit from the DIN-rail.

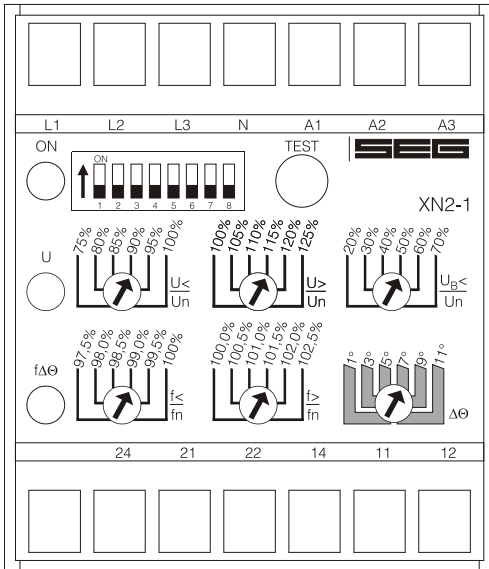

Figure 4.1: Front plate XN2-1

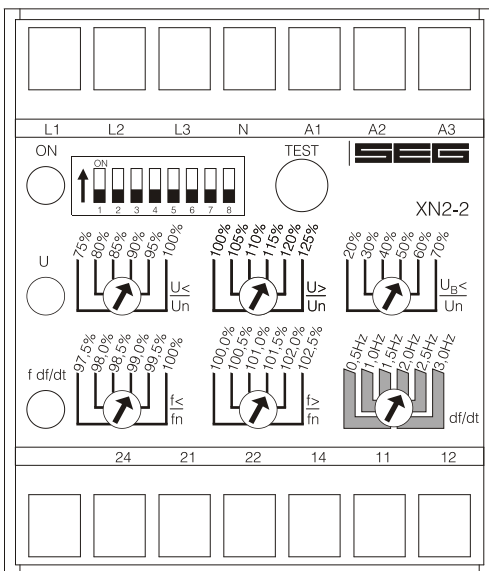

Figure 4.2: Front plate XN2-2

For adjustment of the unit the transparent cover has to be opened as illustrated. Do not use force! The transparent cover has two inserts for labels.

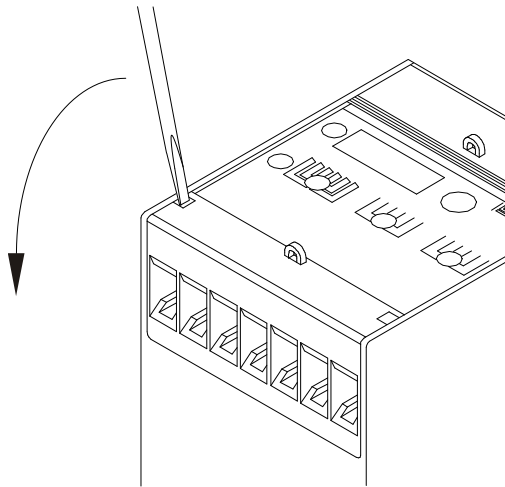

Figure 4.3: How to open the transparent cover

LEDs

LED "ON" is used for display of the readiness for operation (at applied auxiliary voltage U_v) and besides this it flashes when the phase sequence is wrong (see table 4.1). LED U indicates undervoltage by flashing, at overvoltage the LED is lit steady. Flashing of the LED $f \Delta\theta$ indicates tripping because of underfrequency at overfrequency the LED is steady lit. A short flash of the LED $f \Delta\theta$ □ indicates vector surge tripping.

Test push button

This push button is used for test tripping of the unit and when pressed for 5 s a check-up of the hardware takes place. Both output relays are tripped and all tripping LEDs light up.

4.1 Setting of DIP-switches

The DIP-switch block on the front plate of unit XN2 is used for adjustment of the nominal values and setting of function parameters:

DIP-switch	OFF	ON	Funktion
1*	Un = 100 V	Un = 110 V	setting of rated voltage
2*	Un = 100 V	Un = 230 V	
3*	Un = 100 V	Un = 400 V	
4	Y	Δ	measurement phase-to-neutral / phase-to-phase voltage
5	3 %	10 %	switching hysteresis at voltage protection
6*	50 Hz	60 Hz	rated frequency
7*	x 1	x 2	multiplier for vector surge setting
8*	1-phase	3-phase	switchover 1-phase - 3-phase measuring

Table 4.1: Function of DIP-switches

DIP-switch	OFF	ON	Funktion
1*	Un = 100 V	Un = 110 V	setting of rated voltage
2*	Un = 100 V	Un = 230 V	
3*	Un = 100 V	Un = 400 V	
4	Y	Δ	measurement phase-to-neutral / phase-to-phase voltage
5	3 %	10 %	switching hysteresis at voltage protection
6*	50 Hz	60 Hz	rated frequency
7*	4 Perioden	8 Perioden	df/dt supervision time
8*	1-phase	3-phase	switchover 1-phase - 3-phase measuring

Table 4.2: Function of DIP-switches

* Only one of the DIP-switches 1 - 3 shall be in „ON“ position at the same time

Rated voltage

The required rated voltage (phase-to-phase voltage) can be set with the aid of DIP-switch 1 - 3 to 100, 110, 230 or 400 V AC. It has to be ensured that only one of the three DIP-switches is switched on. The following DIP-switch configurations for adjustment of the rated voltage are allowed.

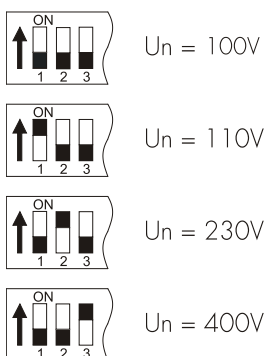

Figure 4.4: Adjustment of rated voltage

Rated voltage chosen too low does not cause destruction of the unit but leads to wrong measuring results which may lead to false trippings.

Measurement phase-to-neutral / phase-to-phase voltage

The phase-to-neutral (position "OFF") or phase-to-phase voltage (position "ON") can be measured by means of switching over the DIP-switch 4.

By measuring phase-to-neutral voltage a displacement of the neutral point will be detected.

If the phase-to-phase voltage is measured, a displacement of the neutral point will not be detected.

Instead of it the values of the three phase-to-phase voltages in the phase triangle will be detected.

In single phase operation DIP-switch 4 has to be set to OFF, in 3-phase operation without N

DIP-switch 4 has to be set to ON. In single phase operation the phase sequence supervision is blocked.

Phase sequence supervision

Flashing LED "ON" indicates wrong phase sequence and all output relays will be tripped, steady lit LED "ON" indicates correct phase sequence. If the measuring voltage drops below $U_{B<}$ the phase sequence supervision is blocked.

Switching hysteresis of the voltage protection

The switching hysteresis of the voltage protection can be set with the aid of DIP-switch 5 to 3 or 10% of the tripping value.

Rated frequency

With the aid of DIP-switch 6 unit XN2 can be set to 50 or 60 Hz, depending upon the given mains characteristics.

Switching hysteresis of the frequency protection

The switching hysteresis of the frequency protection is fixed to 0.25 % of f_n .

Switching over from 1-phase/3-phase measuring (XN2-1)

For single-phase supervision the DIP switch 8 must be set to position OFF. Tripping takes place when in at least one phase the set limit value $\Delta\theta$ is exceeded and the surge in the remaining phases is not bigger than 1° in the opposite direction. In case of single-phase supervision the phase sequence is switched off. Nevertheless, the "single-phase supervision" can also be set with three-phase connection.

For three-phase supervision the DIP switch 8 must be set to position ON. Tripping takes place when in at least two of the three phases the set limit value $\Delta\theta$ is exceeded and the surge in the remaining phase is not bigger than 1° in the opposite direction.

Both measuring systems are only active if the blocking time of $t_v = 5$ s has expired and the phase voltages exceed the blocking voltage $U_{B<}$.

Thanks to the criterium of the angular surges in opposite direction, unintended switching off during balancing processes is prevented.

Switching over from 1-phase/3-phase measuring (XN2-2)

If DIP switch 8 is in position OFF, the phase sequence supervision system is switched off.

If DIP switch 8 is in position ON, the phase sequence supervision system is active.

DIP switch 8 has no influence on frequency gradient supervision.

4.2 Setting of the tripping values

Undervoltage supervision $U_{<}$

The tripping value at undervoltage is continuously adjustable in the range from 75 - 100 % U_n with the aid of potentiometer $U_{<}/U_n$.

Overvoltage supervision $U_{>}$

The tripping value at overvoltage is adjustable in the range from 100 - 125 % U_n with the aid of potentiometer $U_{>}/U_n$.

Underfrequency supervision $f_{<}$

The tripping value at underfrequency is adjustable in the range from 97.5 - 100 % f_n with the aid of potentiometer $f_{<}/f_n$. If the measuring voltage drops below $U_{B<}$ tripping is blocked.

Overfrequency supervision $f_{>}$

The tripping value at overfrequency is adjustable in the range from 100 - 102.5 % with the aid of potentiometer $f_{>}/f_n$. If the measuring voltage drops below $U_{B<}$ tripping is blocked.

Vector surge tripping $\Delta\theta$ (XN2-1 only)

The pickup value for vector surge tripping is adjustable in the range from 1 to 11° in 2° and in the range from 2 - 22° in 4° steps (refer to DIP-switch 7). If the measuring voltage drops below $U_{B<}$ tripping is blocked.

Frequency gradient element df/dt (XN2-2 only)

The frequency gradient element can be set in the range from 0,5 - 3 Hz/s in 0,5 Hz/s steps. In addition the supervision time can be set either to 4 or 8 periods (DIP-switch 7). Tripping will be blocked, if the measuring voltage falls below $U_{B<}$.

Blocking time

To prevent wrong trippings caused by oscillations after the synchronizing procedure, vector surge tripping is blocked after applying the measuring voltage for time t_v . The time delay t_v is fixed to 5 s. If the measuring voltage drops below $U_{B<}$ the blocking time t_v is reset. t_v is activated again if the measuring voltage exceeds $U_{B<}$.

Blocking voltage $U_{B<}$

The blocking voltage can be set in the range from 20 - 70 % U_n .

4.3 Communication via serial interface adapter XRS1

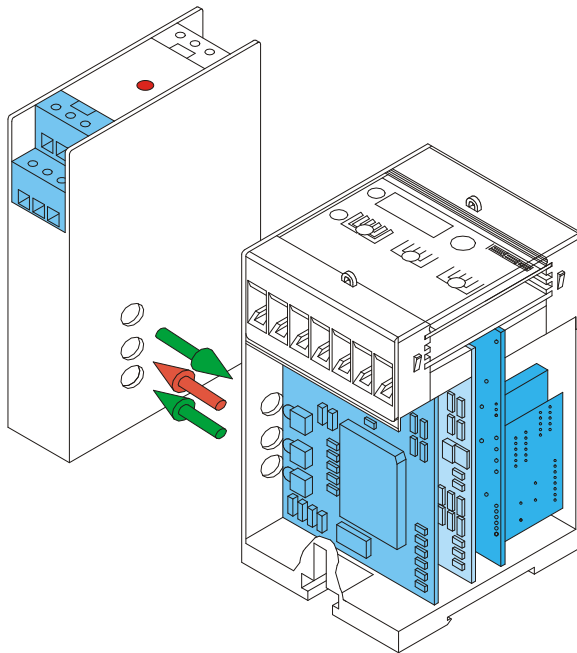

Figure 4.5: Communication principle

For communication of the units with a superior management system, the interface adapter XRS1 is available for data transmission, including operating software for our relays. This adapter can easily be retrofitted at the side of the relay. Screw terminals simplify its installation. Optical transmission of this adapter makes galvanic isolation of the relay possible. Aided by the software, actual measured values can be processed, relay parameters set and protection functions programmed at the output relays. Information about unit XRS1 in detail can be taken from the description of this unit.

5. Relay case and technical data

5.1 Relay case

Unit XN2 is designed to be fastened onto a DIN-rail acc. to DIN EN 50022, same as all units of the PROFESSIONAL LINE.

The front plate of the unit is protected with a sealable transparent cover (IP40).

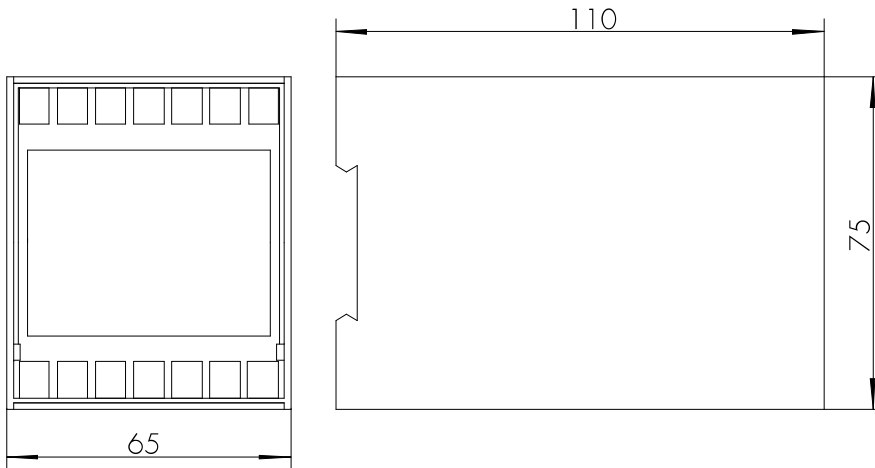

Figure 5.1: Dimensional drawings

Connection terminals

The connection of up to a maximum of 2 x 2.5 mm² cross-section conductors is possible. For this the transparent cover of the unit has to be removed (see para. 4).

5.2 Technical data

Connection possibilities:

System voltage	Setting Un	Connection	Setting	Connection	Setting	Connection	Setting
100/58 V	100 V	58 V single-phase	Y	100 V 3-phase	Δ	100/58 V four wire	Y/Δ
110/63 V	110 V	63 V single-phase	Y	110 V 3-phase	Δ	110/63 V four wire	Y/Δ
230/130 V	230 V	130 V single-phase	Y	230 V 3-phase	Δ	230/130 V four wire	Y/Δ
400/230 V	400 V	230 V single-phase	Y	400 V 3-phase	Δ	400/230 V four wire	Y/Δ
690/400 V		not possible		not possible		not possible	

Table 5.1: Connection possibilities

Measuring input circuits

Rated voltage Un:	100, 110, 230; 400 V/AC (phase-to-phase voltage)
Rated frequency fn:	50/60 Hz
Rated frequency range:	35 - 78 Hz (35 - 66 Hz at communication via serial interface)
Power consumption in voltage circuit:	1 VA/per phase at Un
Thermal capacity of the voltage circuit:	continuously 520 V/AC
Auxiliary voltage Rated auxiliary voltage Uv/:	36 - 520 V AC (f = 35 - 78 Hz) or 50 - 750 V DC/4 W (terminals A1-A3)
Power consumption:	19 - 55 V DC / 3 W (terminals A1 (L-) and A2 (L+))

Common data

Dropout to pickup ratio:	depending on the adjusted hysteresis
Resetting time from pickup:	<50 ms
Returning time from trip:	500 ms
Minimum initialization time after supply voltage has applied:	150 ms
Minimum response time when supply voltage is available:	50 ms for U and f / 70 ms for vector surge (XN2-1)
df/dt (XN2-2)	4 periods supervision time (DIP 7 = OFF) 130 ms with deviations from set value >0.3 Hz/s 8 periods supervision time (DIP 7 = ON) 170 ms with deviations from set value >0.3 Hz/s
Time lag error class index E:	± 20 ms

Output relay

Number of relays:	2
Contacts:	1 changeover contact for each trip relay
Maximum breaking capacity:	ohmic 1250 VA/AC resp. 120 W/DC inductive 500 VA/AC resp. 75 W/DC
Max. rated voltage:	250 V AC
	220 V DC ohmic load I _{max.} = 0,2 A inductive load I _{max.} = 0,1 A at L/R ≤ 50 ms
	24 V DC inductive load I _{max.} = 5 A
Minimum load:	1 W / 1 VA at U _{min} ≥ 10 V
Maximum rated current:	5 A
Making current (16 ms):	20 A
Contact life span:	10 ⁵ hysteresis at max. breaking capacity

System data

Design standard:	VDE 0435 T303; IEC 0801part 1-4, VDE 0160; IEC 255-4; BS 142
Temperature range at storage and operation:	-25° C to +70° C
Constant climate class F acc. to DIN 40040 and DIN IEC 68, T.2-3:	more than 56 days at 40o C and 95% relative humidity
High voltage test acc. to VDE 0435, part 303	
Voltage test:	2.5 kV (eff.) / 50 Hz; 1 min
Surge voltage test:	5 kV; 1.2 /50 µs, 0.5 J
High frequency test:	2.5 kV / 1 MHz
Electrostatic discharge (ESD) acc. to IEC 0801, part 2:	8 kV
Radiated electromagnetic field acc. to IEC 0801, part 3:	10 V/m
Electrical fast transient (burst) acc. to IEC 0801, part 4:	4 kV/2.5 kHz, 15 ms
Radio interference suppression test acc. to DIN 57871 and VDE 0871:	limit value class A
Repeat accuracy:	for U 0.5 %; for f 0.10 %; at vector surge 0.2°
Basic time delay accuracy:	0.5 % or ±25 ms
Accuracy of the specific rated values:	for U: Un = 100 V/110 V / 230 V / 400 V 1 % $U_{\text{phase-to-neutral}}$ 1 % $U_{\text{phase-to-neutral}}$ for f: 0.15 % at vector surge: ± 0.4°
Temperature effect:	0.02 % per K for voltage measuring 0.002 % pro K for frequency measuring
Frequency effect:	for voltage measuring: 45 - 66 Hz no tolerance 35 - 45 Hz and 66 - 78 Hz 1 % for vector surge: 0.2° for the whole frequency range

Mechanical test

Shock:	class 1 acc. to DIN IEC 255-21-2
Vibration:	class 1 acc. to DIN IEC 255-21-1

Degree of protection

Front panel:	IP40 at closed front cover
Weight:	approx. 0.7 kg
Mounting position:	any
Relay case material:	self-extinguishing
GL-Approval:	94656-94HH

Parameter	Setting range	Graduation
U<	75 - 100 % Un	continuously variable
U>	100 - 125 %	continuously variable
f<	97.5 - 100 % fn	continuously variable
f>	100 - 102.5 % fn	continuously variable
$\Delta\Theta$	1 - 22° el. or 0.5 - 3 Hz/s	2° el.; 4° el. or 0.5 Hz/s
Switching hysteresis for U> and U<	3 % or 10 %	
Switching hysteresis for f> und f<	0.25 % fixed	
t _v	5 s fixed	
UB<	20 - 70 % Un	continuously variable

Table 5.2: Setting ranges and graduation

Technical data subject to change without notice!

6. Order form

Mains decoupling relay XN2-

with voltage, frequency and vector surge supervision	1
with voltage, frequency and df/dt supervision	2

Setting-list XN2

Project: _____ SEG Electronics GmbH job.-no.: _____

Function group: = _____ Location: + _____ Relay code: - _____

Relay functions: _____ Date: _____

Setting of parameters

Function		Unit	Default settings	Actual settings
U<	Undervoltage	% Un	75	
U>	Overvoltage	% Un	100	
f<	Underfrequency	% fn	97.5	
f>	Overfrequency	% fn	100	
UB<	Blocking voltage	% Un	20	
$\Delta\theta$	Vector surge tripping	°	1°	
df/dt	df/dt supervision	Hz/s	0.55	

DIP-switch	Function	Default settings	Actual settings
1*		100 V	
2*	Adjustment of rated voltage	100 V	
3*		100 V	
4	Measuring phase-to-neutral / phase-to-phase voltage	Y	
5	Hysteresis for U< and U>	3 %	
6	Adjustment of the rated frequency	50 Hz	
7	Multiplier for vector surge setting	x 1	
7	df/dt supervision time	4 periods	
8	single phase/three phase operation	1-phase	

*Only one of the DIP-switches 1 - 3 shall be in „ON“-position at the same time.

Professional Line

www.SEGelectronics.de

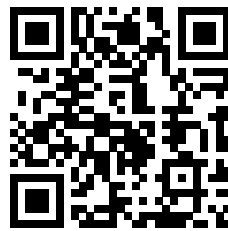

SEG Electronics GmbH reserves the right to update any portion of this publication at any time. Information provided by SEG Electronics GmbH is believed to be correct and reliable. However, SEG Electronics GmbH assumes no responsibility unless otherwise expressly undertaken.



SEG Electronics GmbH
Krefelder Weg 47 • D-47906 Kempen (Germany)
Postfach 10 07 55 (P.O.Box) • D-47884 Kempen (Germany)
Telephone: +49 (0) 21 52 145 1

Internet: www.SEGelectronics.de

Sales
Telephone: +49 (0) 21 52 145 331
Fax: +49 (0) 21 52 145 354
E-mail: info@SEGelectronics.de

Service
Telephone: +49 (0) 21 52 145 614
Fax: +49 (0) 21 52 145 354
E-mail: info@SEGelectronics.de

SEG Electronics has company-owned plants, subsidiaries, and branches, as well as authorized distributors and other authorized service and sales facilities throughout the world.

Complete address / phone / fax / email information for all locations is available on our website.